

LIGHT CHANNEL

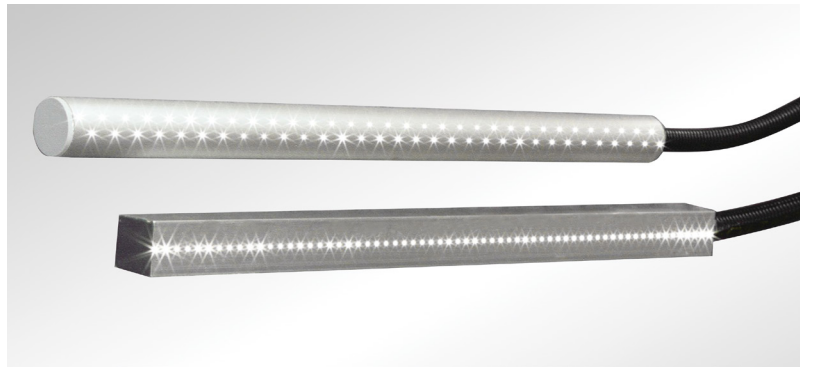
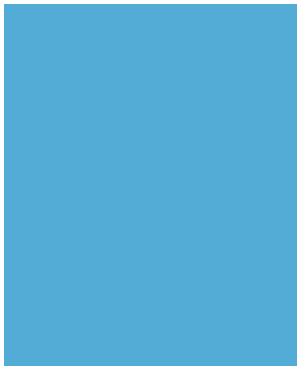

- Custom linear showcase lighting
- Combine wash points and adjustable accent lights
- Multiple lens options
- PMMA or glass fiber
- Full photometrics using VLT Lux Calculator
- Multiple standard finishes; unlimited custom finishes

FIBER OPTIC LIGHTING

Light Channel

Light Channel is a remarkably versatile fiber optic product that produces bright and even linear light. Available in a range of intensities, Light Channel is equally suitable for lighting up a display case, highlighting architectural details, or grazing a rustic stone wall. And like all fiber optic lighting products, Light Channel lends wonderful sparkle to jewelry, especially faceted gems. Light Channel's low profile fits inconspicuously into millwork, coves, or niches, and it is unsurpassed for the edge-lighting of glass panels.

Available in three standard finishes - Silver, Black & Bronze - plus custom finishes and a weatherproof hard anodized version for exterior applications.

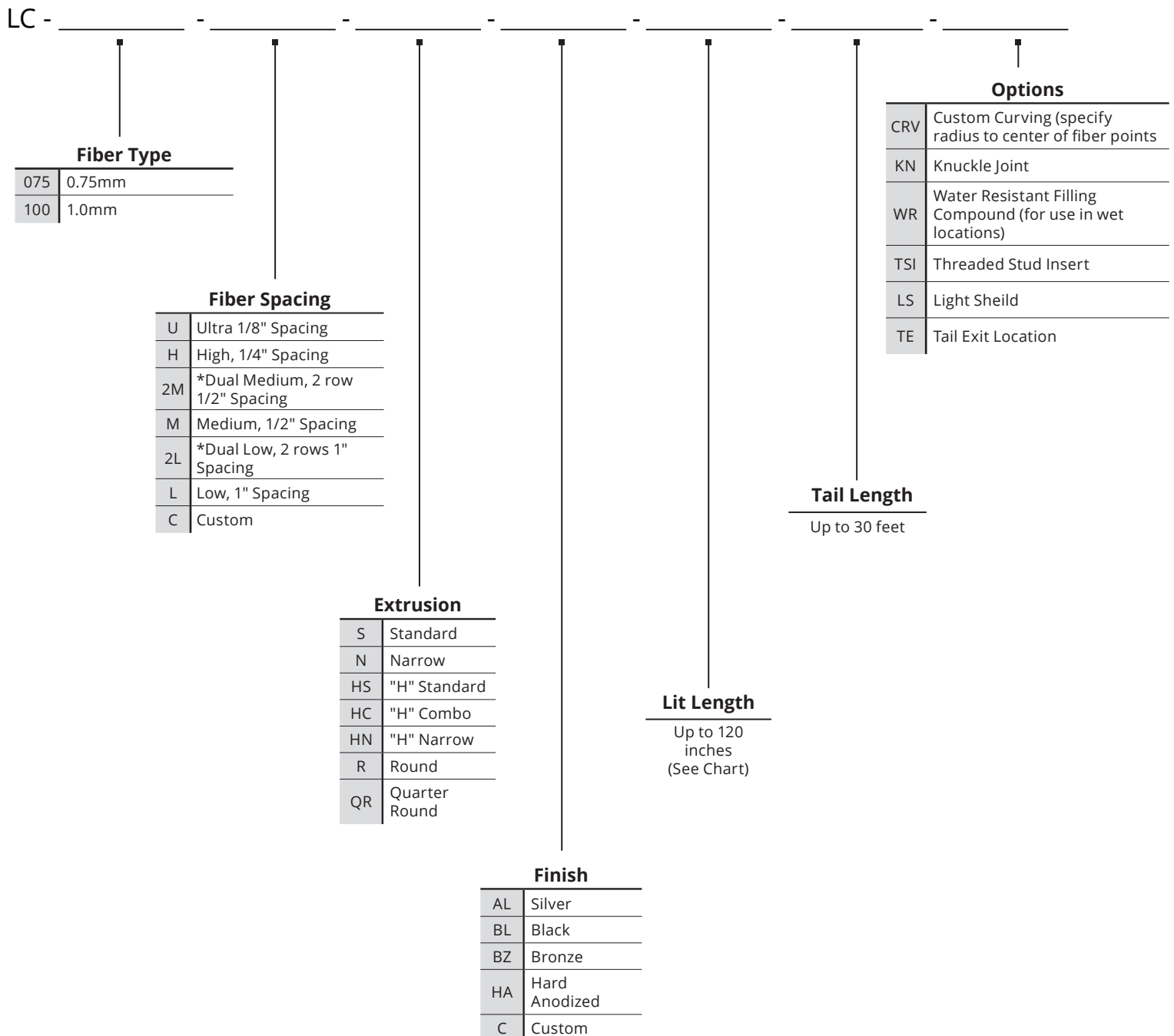

FIBER OPTIC LIGHTING

Light Channel

Extrusions

Light Channel comes in 7 extrusion types. Standard and Narrow are simple channels for discretely lighting areas like niches, display cabinets or architectural details. The "H" option adds an alignment channel that can be helpful for edge lighting applications. Round extrusion has a handsome, finished look for projects where the channel will be visible, and Quarter Round is designed to provide lighting at a 45° angle when fitted snugly into a corner. Both the Round and Quarter Round extrusions offer a "dual" option, providing two rows of light points for a 90° beam angle.

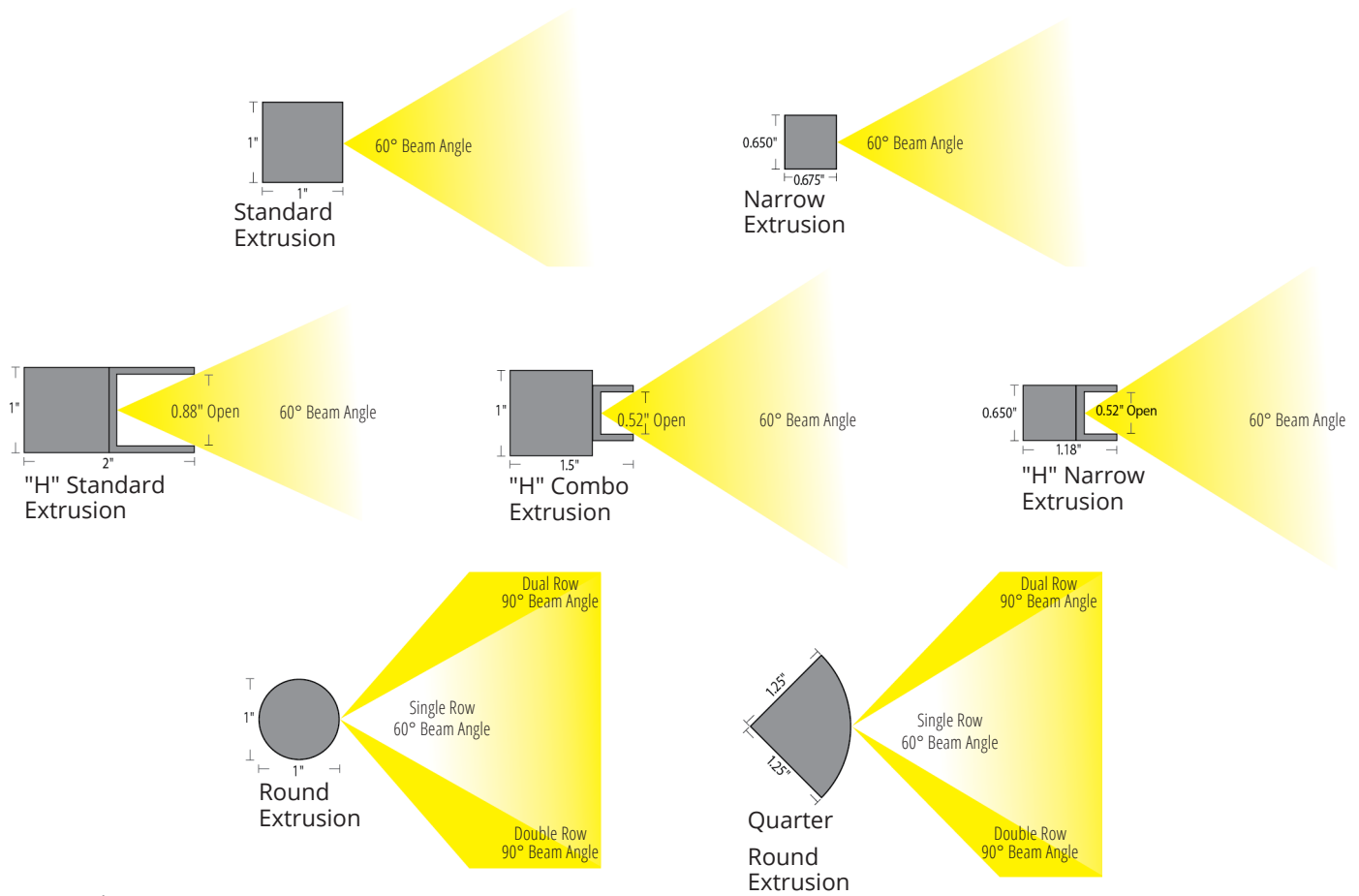

Photometrics

Light output from Light Channel is determined by a number of variables: fiber size, spacing of light points, tail lengths, illuminator, and the utilization of illuminator capacity. The footcandle measurements shown below are based on 4 foot tail lengths and illuminators filled to 50% capacity (500 fibers).

FOOTCANDLES @ 12"										
	Ultra Intensity 1.0mm Fiber	High Intensity 1.0mm Fiber	Ultra Intensity 0.75mm Fiber	Medium Intensity 1.0mm Fiber	High Intensity 0.75mm Fiber	Dual Medium 0.75mm Fiber	Low Intensity 1.0mm Fiber	Medium Intensity 0.75mm Fiber	Dual Low 0.75mm Fiber	Low Intensity 0.75mm Fiber
42 watt LED	795 fc	438 fc	398 fc	214 fc	194 fc	168 fc	96 fc	90 fc	81 fc	55 fc
20 watt LED	261 fc	142 fc	134 fc	75 fc	65 fc	46 fc	30 fc	29 fc	23 fc	18 fc

Light Channel

Maximum Lit Length Chart

The number of light points possible on a length of Light Channel is limited by the space inside the extrusion. The chart below shows "Maximum Lit Length" – the inches of actual light points – possible with each type of extrusion. Extrusion length can be longer than lit length: maximum extrusion length for Standard or Round = 120", maximum extrusion length for Narrow, "H" Narrow, "H" Combo or Quarter Round extrusions = 96".

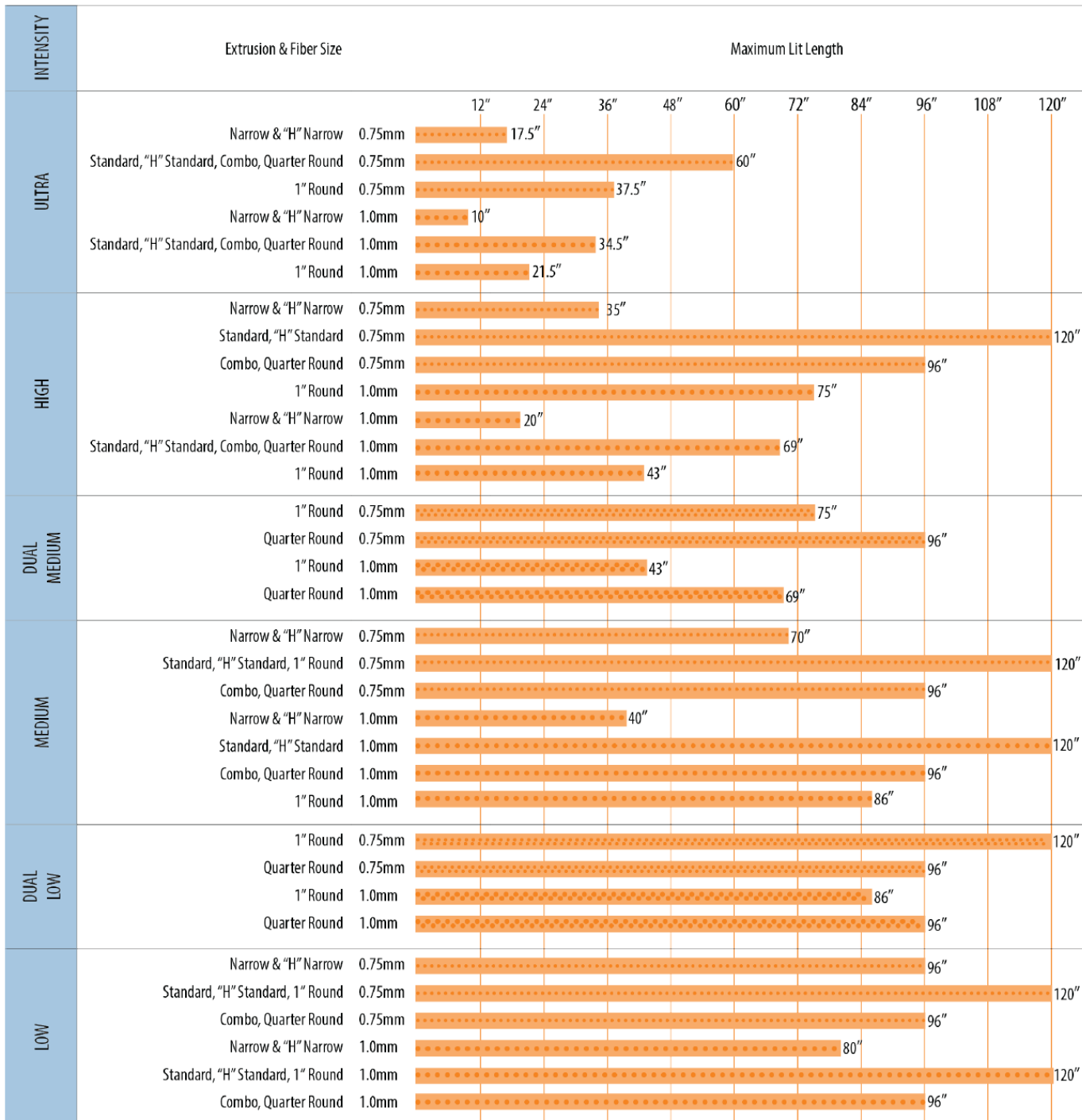

Light Channel

Fiber Optic Tails

There are many ways for fiber optic tails to exit a piece of Light Channel; the best choice for your application will depend on your design layout. The pictures below show the tail exits possible with different extrusion types. Use the tail exit identifier (i.e. "TR3") from the diagram to specify your tail exit(s). TE1 is standard and does not need to be specified.

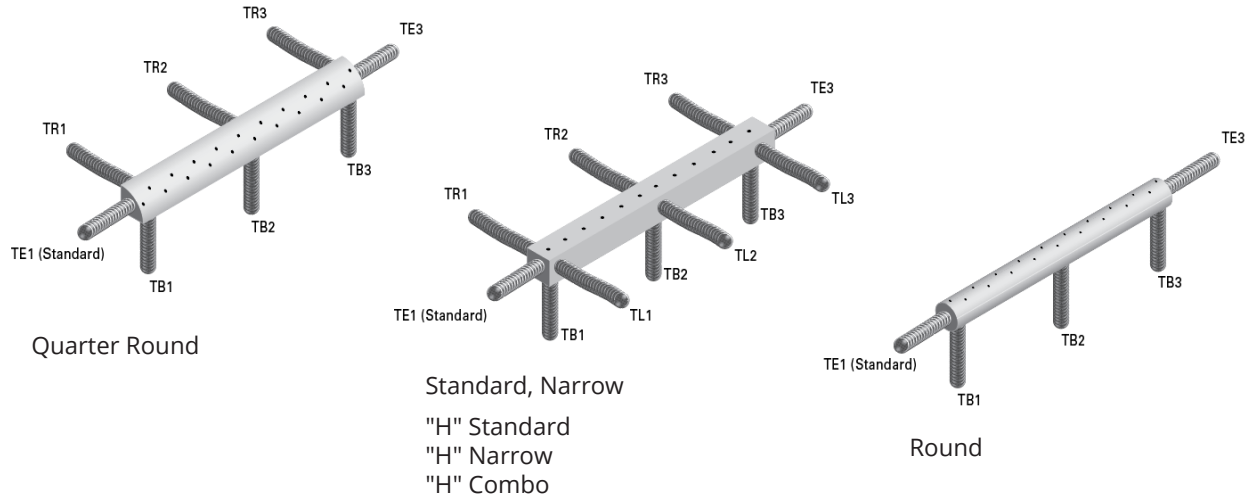

The diameter of a fiber optic tail is determined by the number of fibers in the Light Channel. Calculate the number of fibers by multiplying the inches of Lit Length by the appropriate Fibers per Inch number below (i.e. 36" Lit Length High Intensity x 4 Fibers per Inch = 144 fibers).

Intensity	Ultra	High	Dual Medium	Medium	Dual Low	Low
Fibers per Inch	8	4	4	2	2	1

Flex hose is used to protect the fiber optic tails. The outside diameter and bend radius of the flex hose should be considered when routing tails through millwork or other tight spaces. Using the example above, a tail of 144 - 0.75mm fibers would use an 18.5mm flex hose.

FLEX-HOSE DIAMETER	13.0mm (.51")	16.0mm (.63")	18.5mm (.73")	21.1mm (.83")	25.6mm (1.01")
OUTSIDE DIAMETER SHOWN TO SCALE					
MIN. BEND RADIUS	R = 1.5"	R = 1.75"	R = 2.0"	R = 2.25"	R = 2.5"
MAX FIBERS 0.75MM	0 - 75	76 - 140	141 - 175	176 - 250	251 - 480
MAX FIBERS 1.0MM	0 - 43	44 - 80	81 - 100	101 - 143	144 - 276

Light Channel

Penetration of Light Through Glass

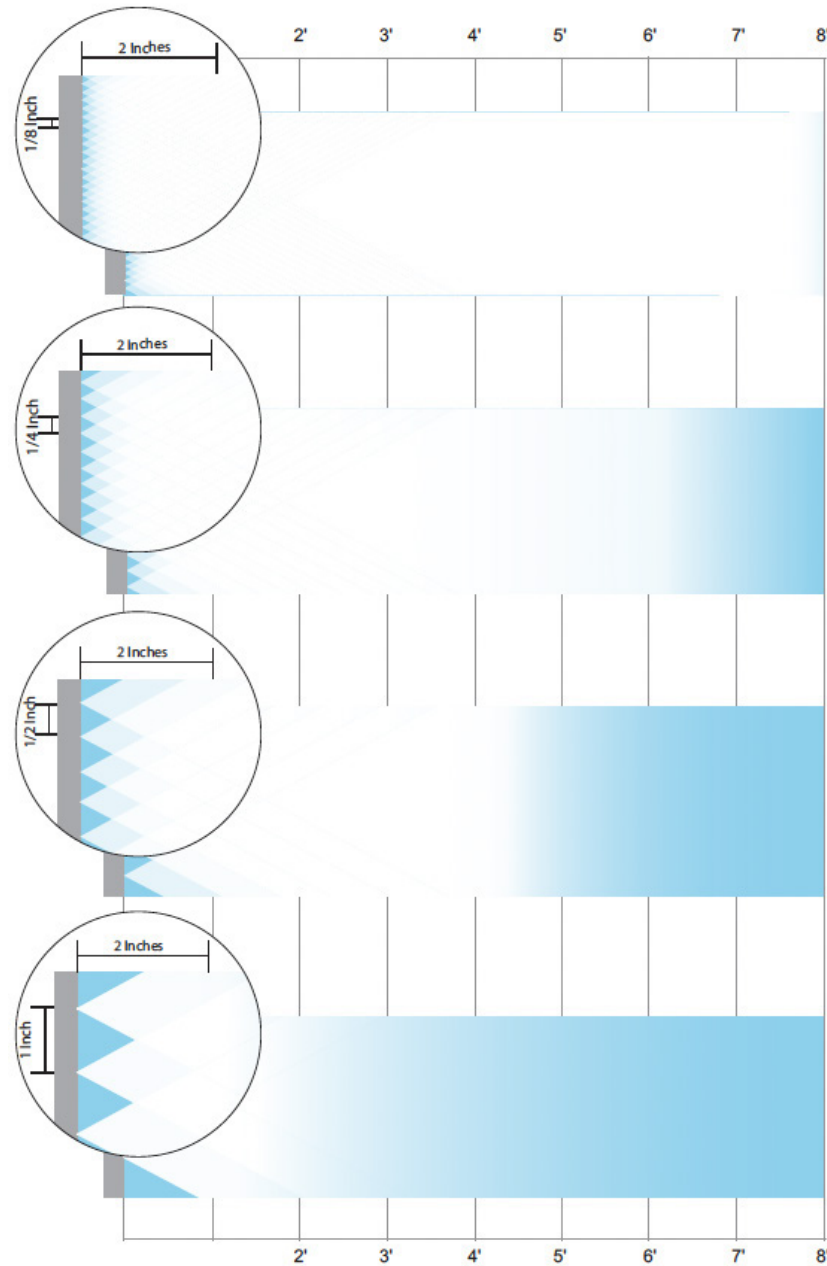

The diagram at left shows how far light will transmit through an 8 foot panel with approximately 25% etched surface. The circled “close-up” views show how the spacing of the light points determines the amount of “scalloping” that will be visible in the first 2 inches. Light penetration can be doubled by edge-lighting from two sides. Depending on the configuration, additional sides can also be lit.

1. FULL-SIZE MOCK-UPS ARE HIGHLY RECOMMENDED FOR ALL EDGE-LIT GLASS PROJECTS.
2. Successful edge-lighting of glass requires the use of LOW IRON glass, also referred to as “white glass” or “Starfire” glass. Low iron glass is an optically clear glass that allows light to penetrate. As a general rule, if you cannot see through the edge of a glass panel, light will not transmit through it.
3. Tinted or colored glass CANNOT be effectively edgelit with Light Channel. Edge-lighting of textured or tempered glass may result in strange patterns.
4. Clear acrylic is an excellent alternative to glass for use in edge-lit applications. Acrylic panels as large as 4' x 8' can be very effectively lit using high intensity Light Channel on two sides.
5. When etching designs on glass or acrylic panels, VLT recommends leaving 2 inches of the panel clear (un-etched) along the side or sides where the light will be projected into the glass. Without this clear margin, scalloping in the etched design will result.
6. Edge-lighting of 100% frosted glass or acrylic panels is NOT RECOMMENDED. Such panels will show a dramatic loss of light intensity just a few inches into the material.
7. Some etching is NECESSARY for glass or acrylic panels to “glow”; without etching, light simply passes through the panel and exits on the other side. Only the etched portions will appear lit.
8. If using laminated glass, the etched design will exist on just one layer of glass. The light points must be aligned with this etched layer, NOT centered on the seam between the layers.
9. “H” extrusions are a good choice for edge lighting glass because the extrusion centers the glass automatically. Standard and Narrow extrusions can also be used, but require blocking to ensure that the glass panel is centered on the extrusion.

XPO Series

Number of Fibers Per Illuminator

All lamps, whether halogen or metal halide, have bright spots and differences in color temperature across the face of the lamp. Optic fibers transmit light directly from the lamp, so those variances show up in the individual light points of Light Channel. Along the length of the channel, each point may be brighter or dimmer than the point next to it, and also may have a slightly different tint. When the light from the Light Channel is given enough throw distance to blend, these difference become imperceptible. But in applications with short throw distances, such as wall grazing or glass edge-lighting, these differences are quite noticeable.

One way to minimize the differences is to use fewer fibers in each illuminator. This keeps all of the fibers closer to the center of the lamp, where the intensity and color temperature are more consistent. The chart below shows the maximum number of fibers per illuminator based on throw distance..

Throw Distance*	0" - 3"	3" - 6"	6" - 9"	9" and up
# of fibers per illuminator	300 - 0.75mm	500 - 0.75mm	700 - 0.75mm	1000 - 0.75mm
	173 - 1.0mm	288 - 1.0mm	403 - 1.0mm	575 - 1.0mm

*Measured to point where light first touches a visible surface

Fixture Options

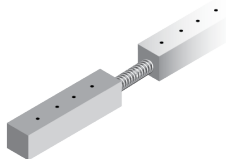
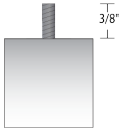
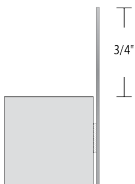
Specifications		CAT. NO. - KN
	<p>Options: Knuckle Joint</p> <p>Primary Material: Nylon</p> <p>Bend Radius: 2.5"</p> <p>For Extrusions: Standard, Narrow, "H"Standard, "H"Combo, "H"Narrow, Quarter Round</p>	<p>Description: Flexible joint connecting two segments of Light Channel extrusion; customizable length.</p> <p>Finishes Available: Black (BL)</p>
Specifications		CAT. NO. - TSIS -
	<p>Options: Threaded Stud Insert</p> <p>Primary Material: Aluminum or Stainless Steel</p> <p>For Extrusions: Standard, Narrow, "H"Standard, "H"Combo, "H"Narrow, Quarter Round</p>	<div style="border: 1px solid black; padding: 2px; text-align: center;">AL SS</div> <p>Description: Threaded Stud for attachment of 8-32 nut; installs into rear of Light Channel extrusion; typically spaced on 2' centers.</p> <p>Finishes Available: Aluminum (AL), Stainless Steel (SS)</p>
Specifications		CAT. NO. - LS
	<p>Options: Light Shield</p> <p>Primary Material: Aluminum</p> <p>For Extrusions: Standard, Narrow</p>	<p>Description: Aluminum shield to reduce glare in certain applications of Light Channel; finish to match that of Light Channel.</p>

XPO Series

Mounting Components for Non-Round Extrusions

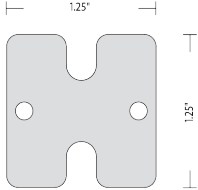
Specifications	CAT. NO. LC - AC - BR -	
	<p>Accessory: Mounting Bracket</p> <p>Primary Material: CRS (Cold Rolled Steel) or Stainless steel</p> <p>For Extrusions: Standard, Narrow, "H"Standard, "H"Combo, "H"Narrow, Quarter Round</p>	<p>Description: Light Channel mounting bracket for non-round extrusions; field bendable for adjustment of focus angle; through holes for #8 screw; includes 3M VHB tape for attachment.</p> <p>Finishes Available: Silver CRS (AL), Black CRS (BL), Stainless Steel (SS)</p>
		<div style="border: 1px solid black; padding: 2px;">AL</div> <div style="border: 1px solid black; padding: 2px;">BL</div> <div style="border: 1px solid black; padding: 2px;">SS</div>

System Components for Round Extrusions

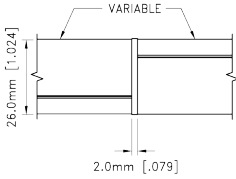
Specifications	CAT. NO. XP - AC - SW -	
	<p>Component: Swivel Connector</p> <p>Primary Material: Aluminum</p> <p>For Extrusions: Round</p>	<p>Description: Light Channel swivel connector for Round Extrusion; connects two Channel segments in strait line; allows connected segments to rotate in different directions.</p> <p>Finishes Available: Silver (AL), Black (BL), Bronze (BZ)</p>
		<div style="border: 1px solid black; padding: 2px;">AL</div> <div style="border: 1px solid black; padding: 2px;">BL</div> <div style="border: 1px solid black; padding: 2px;">BZ</div>

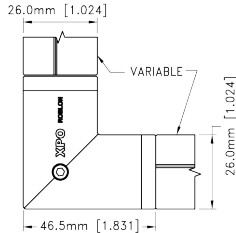
Specifications	CAT. NO. XP - AC - RA -	
	<p>Component: Right Angle Connector</p> <p>Primary Material: Aluminum with</p> <p>For Extrusions: ABS Plastic Cover Round</p>	<p>Description: Light Channel right angle connector for Round Extrusion; connects two Channel segments at a 90° angle; allows connected segments to rotate in different directions.</p> <p>Finishes Available: Silver (AL), Black (BL)</p>
		<div style="border: 1px solid black; padding: 2px;">AL</div> <div style="border: 1px solid black; padding: 2px;">BL</div>

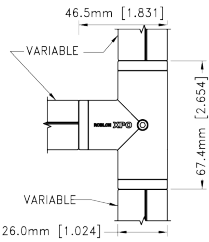
Specifications	CAT. NO. XP - AC - T -	
	<p>Component: "T" Connector</p> <p>Primary Material: Aluminum with</p> <p>For Extrusions: ABS Plastic Cover Round</p>	<p>Description: Light Channel "T" connector for Round Extrusion; connects three Channel segments in "T" configuration; allows three connected segments to rotate in different directions.</p> <p>Finishes Available: Silver (AL), Black (BL), Bronze (BZ)</p>
		<div style="border: 1px solid black; padding: 2px;">AL</div> <div style="border: 1px solid black; padding: 2px;">BL</div>

XPO Series - The Rules of XPO

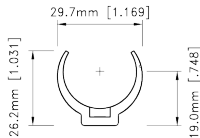
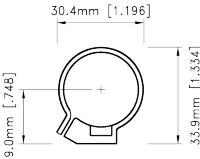
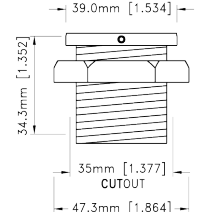
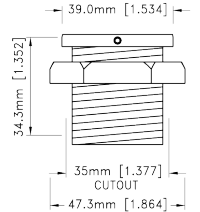
Specifications		CAT. NO. XP - AC - MC -	
	<p>Accessory: Mounting Clip</p> <p>Primary Material: ABS Plastic</p> <p>For Extrusions: Round</p>	<p>Description: Light Channel mounting clip for round extrusion; attaches channel to parallel mounting surface; channel "snaps" into clip allowing for free rotation of light bar.</p> <p>Finishes Available: Silver (AL), Black (BL)</p>	<div style="border: 1px solid black; padding: 2px; text-align: center;">AL BL</div>
Specifications		CAT. NO. XP - AC - BR -	
	<p>Accessory: Mounting Bracket</p> <p>Primary Material: ABS Plastic</p> <p>For Extrusions: Round</p>	<p>Description: Light Channel mounting bracket for round extrusion; attaches channel to parallel mounting surface; channel locks into bracket keeping light bar from rotating; screws included.</p> <p>Finishes Available: Silver (AL), Black (BL)</p>	<div style="border: 1px solid black; padding: 2px; text-align: center;">AL BL</div>
Specifications		CAT. NO. XP - AC - MB -	
	<p>Accessory: Mounting Bushing - Closed End</p> <p>Primary Material: Aluminum</p> <p>For Extrusions: Round</p>	<p>Description: Light Channel mounting bushing for round extrusion; threaded with nut for fixing channel to perpendicular surface; closed-end bushing provides additional support for light bar.</p> <p>Finishes Available: Silver (AL), Black (BL), Bronze (BZ)</p>	<div style="border: 1px solid black; padding: 2px; text-align: center;">AL BL BZ</div>
Specifications		CAT. NO. XP - AC - PB -	
	<p>Accessory: Mounting Bushing - Pass Through</p> <p>Primary Material: Aluminum</p> <p>For Extrusions: Round</p>	<p>Description: Light Channel mounting bushing for round extrusion; threaded with nut for fixing channel to perpendicular surface; pass-through bushing with open end provides leeway for installation into fixed spaces.</p> <p>Finishes Available: Silver (AL), Black (BL), Bronze (BZ)</p>	<div style="border: 1px solid black; padding: 2px; text-align: center;">AL BL BZ</div>

XPO Series - The Rules of XPO

Mounting Instructions

Light Channel Mounting Brackets allow pieces of square, "H", and Quarter Round Light Channel to be mounted at the desired angle for the application. Both Very High Bond (VHB) Tape and Threaded Stud Inserts can be used to attach Light Channel to the mounting surface. Light Channel can also be glued into small niches to provide concealed lighting.

Non-Round Extrusions:

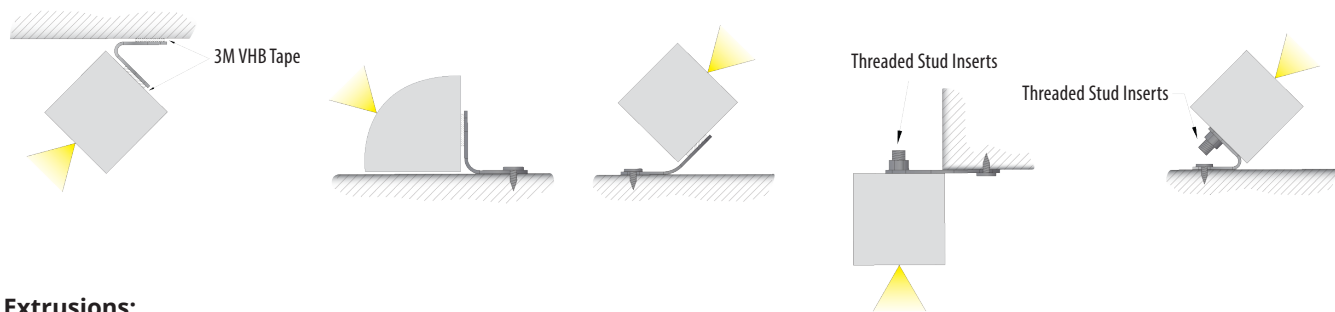

Round Extrusions:

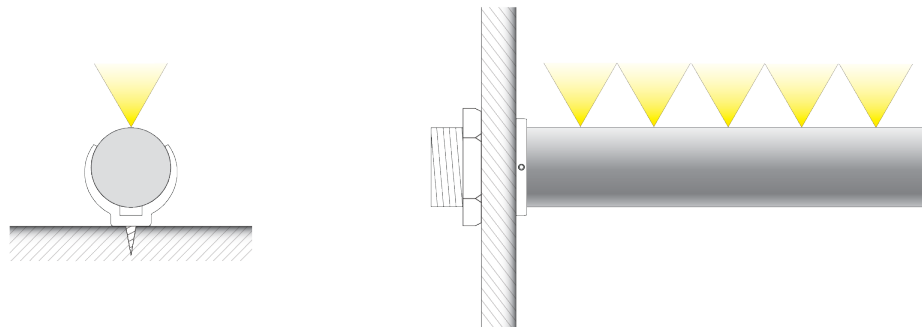

Light Channel Application Notes

1. Light Channel is a custom manufactured product and can be configured to your application needs. Consult factory to discuss your specific design requirements.
2. Light Channel extrusion can be radius curved to your specifications. Consult factory for recommendations.
3. Several small pieces of Light Channel can be connected using Knuckle Joints that allow Light Channel to fit around curves or bends. Channel to be configured with a minimum number of tail exits. Consult factory for recommendations..
4. Depending on fiber spacing and mounting distance, a scalloping effect may be visible in the finished application (see diagram on page 119 regarding scalloping in edge-lit glass). Light Channel can be mounted at variable distances from the lit surface to achieve the desired effect, whether scalloped or uniform wash.
5. Light Channel is shipped with blue protective film over the fibers; please remove film after product has been installed.