

# EssentialLEDs®

- *LINEAR FIXTURES*
- *CHOICE LINEAR FIXTURES*
- *SUSPENDED FIXTURES*
- *SPECIALTY DISPLAY FIXTURES*
- *LED LIGHT PANEL*
- *FLEXIBLE LEDS*
- *DRIVERS AND POWER PANELS*

2018/2019





## LINEAR

Linear Fundamentals .....	9
LED Board Options .....	10
Fixture Length & Wattage Table .....	14
Lensing Options .....	19
Fixture Extrusions Overview .....	20
Mini LightRun .....	21
ML1 Mini Designer Extrusion .....	22
1S Small Square Extrusion .....	23
7SL Small Square Extrusion .....	24
8SL Medium Square Extrusion .....	25
8CL Medium Square Compact Extrusion .....	26
8FL Medium Square Flanged Extrusion .....	27
9SL Large Square Extrusion .....	28
1QL Quarter Round Extrusion .....	29

2QL Quarter Round Extrusion . . . . .	30
1R Small Round Extrusion . . . . .	31
2RL Large Round Extrusion . . . . .	32
3RL Large Round Extrusion . . . . .	33
1EL Demi-Ellipse Extrusion . . . . .	34
5SLW Square Extrusion - Exterior . . . . .	35
4SL Medium Square Extrusion Tall . . . . .	36
Elegance Linear Puck . . . . .	38

**CHOICE LINEAR**

Choice Fundamentals . . . . .	41
Choice LED Board Options . . . . .	42
Choice Fixture Length & Wattage Table . . . . .	43
Choice Fixture Extrusions Overview . . . . .	44
ML1 Choice Mini Designer Extrusion . . . . .	46
1S Choice Small Square Extrusion . . . . .	47
7SL Choice Small Square Extrusion . . . . .	48
8SL Choice Medium Square Extrusion . . . . .	49
8CL Choice Medium Square Compact Extrusion . . . . .	50
8FL Choice Medium Square Flanged Extrusion . . . . .	51
9SL Choice Large Square Extrusion . . . . .	52
1QL Choice Quarter Round Extrusion . . . . .	53
2QL Choice Quarter Round Extrusion . . . . .	54
1R Choice Small Round Extrusion . . . . .	55
2RL Choice Large Round Extrusion . . . . .	56
3RL Choice Large Round Extrusion . . . . .	57
1EL Choice Demi-Ellipse Extrusion . . . . .	58
5SLW Choice Square Extrusion - Exterior . . . . .	59



4SL Choice Medium Square Tall Extrusion . . . . .	60
---	----

## **CHOICE /LINEAR ACCESSORIES & INFORMATION**

EssentialEdge Adjustable Shelf Lighting System . . . . .	62
Wire Exits . . . . .	64
Constant Voltage Wiring Accessories . . . . .	65
Mounting Options . . . . .	66
Special Mounting Options . . . . .	72

## **FLEXIBLE**

EFLEX . . . . .	80
EFLEXW . . . . .	82
EFLEX Accessories . . . . .	84

## **SPECIALTY DISPLAY**

Elegance <sup>2</sup> . . . . .	88
Elegance Cylinder . . . . .	90
Elegance Long . . . . .	92
Elegance Puck . . . . .	94
Elegance Mini Puck . . . . .	96
Elegance Micro Puck . . . . .	98
LightRun . . . . .	100
Orb . . . . .	104
Fixture Accessories . . . . .	106

## **SUSPENDED**

Suspended Fundamentals . . . . .	109
Suspended LED Board Options . . . . .	110
Suspended Remote Driver Mounting Options . . . . .	112



Suspended End Mount Canopy Driver Options..... 113  
SR2 Medium Round Pendant ..... 114  
SR3 Large Round Pendant Direct / Indirect ..... 115  
SS1 Square Pendant ..... 116  
SS2 Rectangular Pendant Direct / Indirect..... 117

## LED LIGHT PANEL

About Light Panel ..... 119  
ELP-L ..... 120  
ELP-G..... 126

## POWER PANELS & DRIVERS

LED Driver Power Panels ..... 132  
Constant Current Drivers..... 134  
Constant Voltage Drivers ..... 136  
Custom Mixed CV & CC Drivers ..... 138  
Mini Constant Current Drivers..... 140  
Mini Constant Voltage Drivers ..... 142

## WHAT'S NEW IN ESSENTIALLEDs® 2019

Since their introduction in 2011, our EssentialLEDs products have become the easy answer for accent, task and display applications, combining useful and imaginative fixtures with exceptional lighting quality. In our 2019 catalog, we're excited to bring you the best of our previous offerings along with new energy efficiency listings, new High CRI offerings, Ultra High CRI availability, and a new value-driven CHOICE in linear fixtures.

### EssentialLEDs CHOICE

Introducing EssentialLEDs CHOICE...a value-focused line of linear LED fixtures using all your favorite profiles. Offering a selection of Narrow Pitch Choice LEDs or Standard Pitch Nichia LEDs, EssentialLEDs CHOICE is a great new way to get the VLT quality and service you've come to expect at a price that fits all budgets.

### Pitchless 757G

We now offer Pitchless LED boards using 757G LEDs resulting in an extra bright output with no "dot" pattern. The HI CRI version of this board (as well as our standard pitch HI CRI boards) are newly available in CCT's down to 2,000K.

### Title 24 JA8-2016

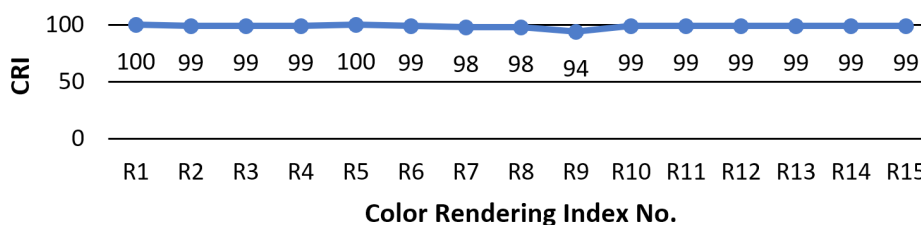
Want another reason to consider EssentialLEDs CHOICE? How about Title 24 JA8-2016 compliance? That's right...along with the exceptional VLT quality and service, EssentialLEDs CHOICE also adheres to the highest cross-section of energy efficiency and color rendering currently available. While Title 24 JA8-2016 compliance may only be mandated in California, this standard has come to be seen as a sign of excellence among designers across the world.

### Specialty Fixtures with High CRI

Our Specialty fixture line has some High CRI news, too. Nichia has recently released a High CRI version of the 219 LED, allowing us to offer these display workhorses in a whole new (quality of) light.

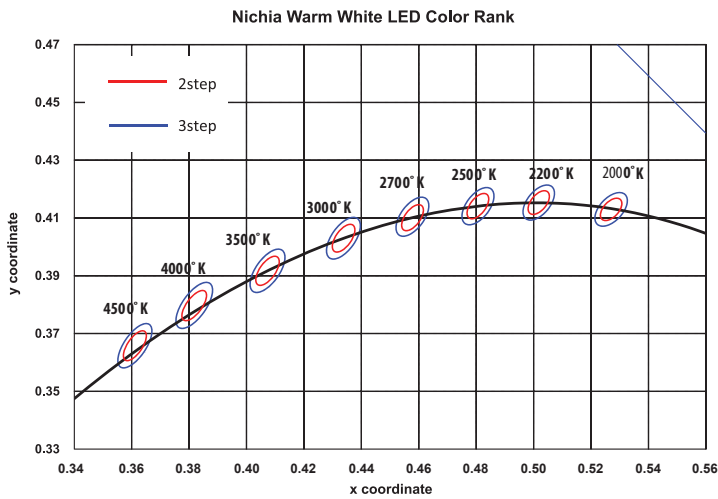
### Optisolis \ Ultra High CRI

Since High CRI seems to be the order of the year, we've saved our biggest High CRI news for last: Introducing Ultra High CRI powered by Nichia Optisolis LEDs. With a CRI of 98 and R9 value of 94, these new LEDs faithfully reproduce the appearance and vibrancy of colors (including whites and pastels) compared to standard light. Available in our EssentialLEDs Linear fixtures, Ultra High CRI LEDs uses blue chips instead of UV chips, eliminating any UV with a very low damage factor.



## BINNING

VLT now offers two levels of binning for the best balance of consistency and economy. 2 MacAdam Ellipse bins provide optimum consistency for boards where LEDs are spaced further apart. 3 MacAdam Ellipse bins are used when higher quantities of LEDs spaced closely together help compensate for minor variations. Whether your chosen LED board uses 2 or 3 MacAdam Ellipse bins, you can be confident that every LED is always drawn from the bin closest to the black body curve (and thus closest to the exact specified color temperature.) The chart below demonstrates the locations and sizes for each of our 2 and 3 MacAdam Ellipse bins.



2 MacAdam Ellipse	3 MacAdam Ellipse
Standard LED Boards (1720, 2730, 4740, 5760, 6760)	Pichless Nichia 757G (5140, 5160, 5180, 3140, 3160, 3180, 3190, 7180)
HI CRI LED Boards (3720, 3740, 3760)	Ultra HI CRI LED Boards (3790)
Pitchless Narrow Focus (5133, 5163)	Choice Narrow Pitch (1435, 2435, 3435, 4435)
Choice Standard Pitch/Eflex (1320, 2320, 4320)	
Specialty (4219, 1250, 4224, 1239, 1184, 1219)	
EssentialLEDs Light Panel (3727, 3718, 3709, 2727, 2718, 2709, 1704)	

## CRI DETAILS (HI CRI & ULTRA HI CRI LED BOARDS)

Index	X	Y	Color	HI CRI	Ultra HI CRI
CRI 01	0.3692	0.3291	Light greyish red	97	100
CRI 02	0.3794	0.3955	Dark greyish yellow	98	99
CRI 03	0.3772	0.4880	Strong yellow green	99	99
CRI 04	0.2892	0.3963	Moderate yellowish green	97	99
CRI 05	0.2578	0.3078	Light bluish green	97	100
CRI 06	0.2360	0.2365	Light blue	94	99
CRI 07	0.2770	0.2372	Light violet	94	98
CRI 08	0.3259	0.2584	Light reddish purple	89	98
CRI 09	0.5492	0.3045	Strong red	76	94
CRI 10	0.4376	0.4601	Strong yellow	97	99
CRI 11	0.2551	0.4162	Strong green	91	99
CRI 12	0.1517	0.1490	Strong blue	78	99
CRI 13	0.3690	0.3510	Light yellowish pink (skin)	97	99
CRI 14	0.3538	0.4284	Moderate olive green (leaf)	99	99
<b>CRI (Ra)</b>	-	-	<b>Average level of CRI 01- 08</b>	<b>96</b>	<b>98</b>

## LINEAR



EssentialLEDs® Linear products combine the best qualities of LED technology - the small size, long life, energy efficiency and great lumen output - to simplify the application of light in interior spaces.

EssentialLEDs® Linear extrusions offer an intriguing range of styles and sizes that are perfect for accent, task and display applications, with a large range of mounting options to provide a solution for most every installation challenge.

EssentialLEDs® Linear products offer custom sizing for perfect integration in a wide variety of architectural or display spaces, while the high CRI, exceptional binning and full range of CCT choices ensure that every application will beautifully enhance the overall space.



LINEAR FUNDAMENTALS

EssentialLEDs® Linear products provide bright, even linear lighting for a variety of interior applications, including architectural accents, coves, niches, millwork, task and display lighting. EssentialLEDs® fixtures can be specified using **any of the 21 LED board options shown on the following two pages**, broken down into five categories:

1. **Standard Boards** - five board options that offer a range of lumen output/wattage options **for most applications**.
2. **Hi CRI Boards** - three board options with a CRI of 95+, for **CA Title 24 JA8-2016 compliance** and superior color rendering of food, artwork and cosmetics.
3. **Ultra Hi CRI Boards** - introducing the **Nichia Optisolis™** LED with an amazing 98 CRI for when only the best will do. (CA Title 24 JA8-2016 compliant.)
4. **Pitchless/Narrow Focus Boards** - LED boards with no spacing between the LEDs allow **full diffusion** in our smaller extrusions (Pitchless boards) or the **tightest light distribution** when used with our Focusing Lenses (Narrow Focus).
5. **Dual Row Boards** - dual rows of Standard or Hi CRI LEDs for **maximum lumen output** in our 9SL fixtures.

The LED boards above can be used in any of **16 linear extrusions**, with standard fixture sizes ranging from **less than 5 inches to almost 12 feet** (finished length options vary based on extrusion and LED board choices).

**EssentialLEDs® Linear products are fully dimmable** and available in multiple standard and custom finishes; lensed extrusions can include diffusing or focusing lenses. Visit [www.vltcorp.com](http://www.vltcorp.com) for application photos and the most recent IES files.

LENSING	Lensed and unlensed options available; lens options include clear or three levels of Opal. Focusing lenses available for 7SL, 8SL, 8CL, 8FL, 9SL, 2RL, 3RL, 1QL and 2QL extrusions.
FINISH	All fixtures available in silver, black or bronze anodized finish; some fixtures also available in white powder coating; custom finishes upon request.
LENGTHS	See Length & Wattage Tables for all standard length options; Standard lengths up to 8ft, Extended lengths up to 12ft.
ELECTRICAL	<p><b>Driver Type:</b> Constant Voltage, Class 2 UL Listed <span style="float: right;"></span></p> <p><b>Input Voltage:</b> 24vDC</p> <p><b>Dimming:</b> ELV, 0-10V, DALI, DMX, Lutron Eco</p> <p><b>Feed Wire:</b> 96" [2.44m] of 20 AWG Wire [1.02mm<sup>2</sup>], Male Connector</p> <p><b>Operating Ambient Temperature:</b> -22° to 104° F [-30° to 40° C]</p> <p><b>Humidity:</b> 90% RH Non-Condensing</p> <p><b>Electrostatic Sensitive Device:</b> VLT Recommends using additional surge protection with this unit (supplied by others). Surge damage is not covered by warranty </p>
LIFE & WARRANTY	50,000 HR lifetime for all Nichia LED's except Optisolis™ with 35,000 HR Lifetime (T <sub>a</sub> = -25°C to 40°C; T <sub>c</sub> max 75°C); 5 year limited warranty
MOUNTING	Mounting options differ according to extrusion; may include fixed and/or adjustable clips, mounting end caps, bushings, free-standing mount, recessed options; up to IP67
LISTINGS & TESTS	<p>cUL<sub>us</sub> (UL 2108 &amp; 8750); CE Marked; LM79, LM80; Title 24 JA8-2016<sup>1</sup>; Dry/Damp; 5SLW Wet Location Rated. (IP Ratings for reference purposes only)</p> <p>1R and 1S NOT UL Listed for closet space; 7SL UL Listed for closet space when using 1720 or 3720 boards; All other extrusions UL Listed for closet space when using 3140 or 3720 boards.</p> <p>The EU's Restriction of Hazardous Substances Directive (RoHS) restricts the use of six hazardous substances* in electrical and electronic equipment (* Lead (Pb), Mercury, Cadmium, Hexavalent chromium, Polybrominated biphenyls and Polybrominated diphenyl ether (PBDE)).</p> <p><sup>1</sup>Please contact factory for current list of JA8-2016 products.</p>

VLT reserves the right to change specifications without notice. Please visit [www.vltcorp.com](http://www.vltcorp.com) for current cut sheets. **MADE IN USA** 

## STANDARD LED BOARDS

LED BOARD	1720	2730	4740	5760	6760
LUMEN OUTPUT <sup>1</sup>	260 lm/ft [853 lm/m]	397 lm/ft [1302 lm/m]	528 lm/ft [1732 lm/m]	665 lm/ft [2181 lm/m]	875 lm/ft [2870 lm/m]
POWER CONSUMPTION	1.8 w/ft [6.0 w/m]	2.9 w/ft [9.5 w/m]	3.7w/ft [12.1 w/m]	4.9 w/ft [16.1 w/m]	6.5 w/ft [21.3 w/m]
CRI	83+	83+	83+	83+	83+
CCT OPTIONS	2000K 2200K 2500K 2700K 3000K 3500K 4000K 4500K 5000K				
APPLIED LED	Nichia 757g	Nichia 757g	Nichia 757g	Nichia 757g	Nichia 757g
BINNING	2 MacAdam Ellipse				
LED EFFICACY <sup>1</sup>	175 lm/w	175 lm/w	175 lm/w	175 lm/w	175 lm/w

<sup>1</sup>Based on 3500K CCT

## HI CRI LED BOARDS 95+

California Title 24 JA8-2016 Compliant (2700K - 4000K)

LED BOARD	3720	3740	3760
LUMEN OUTPUT <sup>2</sup>	223 lm/ft [731 lm/m]	430 lm/ft [1410 lm/m]	609 lm/ft [1998 lm/m]
POWER CONSUMPTION	1.8 w/ft [6.0 w/m]	3.5 w/ft [11.5 w/m]	5.2 w/ft [17.1 w/m]
CRI	95+	95+	95+
CCT OPTIONS	2000K 2200K 2500K 2700K 3000K 3500K 4000K 4500K 5000K		
APPLIED LED	Nichia 757g	Nichia 757g	Nichia 757g
BINNING	2 MacAdam Ellipse		
LED EFFICACY <sup>2</sup>	151 lm/w	151 lm/w	151 lm/w

<sup>2</sup>Based on 3500K CCT

**Our Hi CRI LED boards** feature 757g LEDs with a CRI of 95 or higher. CRI - Color Rendering Index - is a measure of how faithfully an artificial light source renders color compared to sunlight, with a highest score of 100. Hi CRI LEDs are especially important when lighting items such as artwork, food and cosmetics, or in closet applications for distinguishing between black and dark blue clothing.

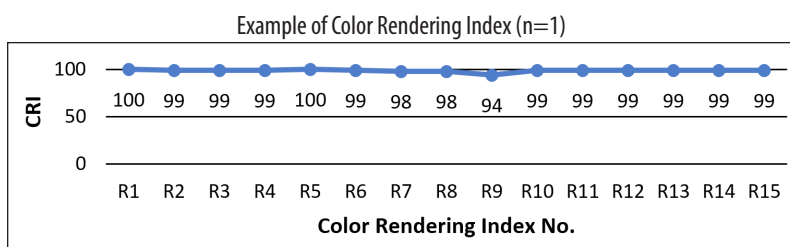
**Additionally,** compliance with California's Title 24 JA8-2016 standard requires that new and remodel residential lighting applications must have a CRI of 90 or above, with a Kelvin temperature (CCT) between 2700K and 4000K.

## New! ULTRA HI CRI LED BOARDS

California Title 24 JA8-2016 Compliant (2700K - 4000K)

Nichia Optisolis™ LEDs achieves Ultra High CRI with a spectrum that demonstrates the closest match to standard incandescent sources. Since UV emission is essentially non-existent, the degradation of lighted materials can be reduced dramatically compared to that of other light sources, including other market available LEDs.

VLT EssentialLEDs™ with Nichia Optisolis™ LEDs target applications include Museum and Art Gallery Lighting, Retail Lighting or anywhere the highest CRI is preferred, but UV radiation can be detrimental.



LED BOARD	3790
LUMEN OUTPUT <sup>3</sup>	621 lm/ft [2037 lm/m]
POWER CONSUMPTION	6.9 w/ft [22.6 w/m]
CRI	98
CCT OPTIONS	2700K 3000K 3500K 4000K 5000K
APPLIED LED	Nichia 757g
BINNING	3 MacAdam Ellipse
LED EFFICACY <sup>3</sup>	138 lm/w

<sup>3</sup>Based on 3500K CCT

**New!** PITCHLESS LED BOARDS - NICHIA 757g

LED BOARD	STANDARD			HI CRI 95+			ULTRA HI CRI			TUNABLE WHITE	
	5140	5160	5180	3140	3160	3180	3150	3170	3190	7180	
LUMEN OUTPUT <sup>1</sup>	287 lm/ft [941 lm/m]	571 lm/ft [1872 lm/m]	920 lm/ft [3017 lm/m]	237 lm/ft [777 lm/m]	469 lm/ft [1538 lm/m]	773 lm/ft [2535 lm/m]	202 lm/ft [662 lm/m]	404 lm/ft [1325 lm/m]	710 lm/ft [2329 lm/m]	750 lm/ft <sup>2</sup> [2460 lm/m]	
POWER CONSUMPTION	2.2 w/ft [7.2 w/m]	4.3 w/ft [14.1 w/m]	6.9 w/ft [22.6 w/m]	2.2 w/ft [7.2 w/m]	4.3 w/ft [14.1 w/m]	6.9 w/ft [22.6 w/m]	2.2 w/ft [7.2 w/m]	3.9 w/ft [12.8 w/m]	6.9 w/ft [22.6 w/m]	6.9 w/ft [22.6 w/m]	
CRI	83+	83+	83+	95+	95+	95+	98	98	98	83+ / 95+	95+
CCT OPTIONS	2000K, 2200K, 2500K, 2700K, 3000K, 3500K, 4000K, 4500K, 5000K			2000K, 2200K, 2500K, 2700K, 3000K, 3500K, 4000K, 4500K, 5000K			2700K, 3000K, 3500K, 4000K, 5000K			2000K/3000K 2500K/4000K	3000K/4000K 3500K/4500K
APPLIED LED	757g	757g	757g	757g	757g	757g	757g	757g	757g	757g	757g
BINNING	3 MacAdam Ellipse			3 MacAdam Ellipse			3 MacAdam Ellipse			3 MacAdam Ellipse	
LED EFFICACY <sup>1</sup>	175 lm/w	175 lm/w	175 lm/w	151 lm/w	151 lm/w	151 lm/w	138 lm/w	138 lm/w	138 lm/w	175/151 lm/w	151/151 lm/w

<sup>1</sup> Based on 3500K CCT    <sup>2</sup> Total Lumen Output with All LEDs at Full Power

"Pitch" is the term used to describe the spacing between LEDs on a circuit board. A "pitchless" board has no spacing between the LEDs, a feature that results in an extra bright board that eliminates the "dot" pattern of LED diodes and allows the diodes to fully diffuse even in small extrusions. Our new pitchless boards use the Nichia 757g LEDs, and will provide full diffusion when paired with Opal lenses. The new pitchless boards are available in three versions - Standard, Hi CRI, Ultra Hi CRI, and a Tunable White LED Board available in four CCT ranges. The new pitchless LED boards can be used with 8SL, 8CL, 8FL, or 9SL linear fixtures.

Pitchless Standard: Lumen output as high as 920 lm/ft, 83+ CRI

Pitchless Hi CRI: Lumen output as high as 773 lm/ft, 95+ CRI

Pitchless Ultra Hi CRI: Lumen output as high as 600 lm/ft, 98 CRI

Pitchless Tunable White: Max lumen output of 750 lm/ft. when all LEDs are at full power; single CCT output approximately 375 lumens. CRI will vary based on CCT choices.

PITCHLESS LED BOARDS FOR NARROW FOCUS

LED BOARD	PITCHLESS/NARROW FOCUS	
	5133	5163
LUMEN OUTPUT <sup>3</sup>	315 lm/ft 1033 lm/m]	548 lm/ft [1797 lm/m]
POWER CONSUMPTION	3.4 w/ft [11.2 w/m]	6.6 w/ft [21.7 w/m]
CRI	87	87
CCT OPTIONS	2700K, 3000K, 3500K, 4000K, 4500K, 5000K	
APPLIED LED	Nichia 157b	Nichia 157b
BINNING	2 MacAdam Ellipse	
LED EFFICACY <sup>3</sup>	108 lm/w	108 lm/w

The 5133 & 5163 boards at left use a narrower Nichia 157b LED, which produces a tighter distribution when used with a focusing lens. The 5133 & 5163 LED boards can produce light distribution as narrow as 18° when used with our Lens 2. See the chart on page 16 for more information on the light distribution options when using the 5133 & 5163 LED boards.

<sup>3</sup> Based on 3500K CCT

## DUAL-ROW FOR MAXIMUM LUMEN OUTPUT

Our 9SL profile can accommodate two LED boards to provide the **maximum lumen output possible** in an EssentialLEDs® linear fixture. The chart at right provides data for two rows of the LED boards most likely to be specified in dual-row configurations. You may specify dual-rows of most of our LED boards in 9SL extrusions; for data on LED boards not included in this chart, please contact the factory.



LED BOARD	3760 D (Hi CRI) <sup>2</sup>	6760 D (Hi OUTPUT)	3790 D (Ultra Hi CRI) <sup>2</sup>
LUMEN OUTPUT <sup>1</sup>	1218 lm/ft [3995 lm/m]	1750 lm/ft [5740 lm/m]	1242 lm/ft [4074 lm/m]
POWER CONSUMPTION	10.4 w/ft [34.1 w/m]	13.0 w/ft [42.7 w/m]	13.8 w/ft [45.3 w/m]
CRI	95+	83+	98
CCT OPTIONS	2000K 2200K 2500K 2700K 3000K 3500K 4000K 4500K 5000K		2700K 3000K 3500K 4000K 5000K
APPLIED LED	Nichia 757g	Nichia 757g	Nichia 757g
BINNING	2 MacAdam Ellipse		3 MacAdam Ellipse
LED EFFICACY <sup>1</sup>	151 lm/w	175 lm/w	138 lm/w

<sup>1</sup> Based on 3500K CCT    <sup>2</sup> California Title 24 JA8-2016 compliant in 2700K-4000K CCT's

## LIGHT OUTPUT CONVERSION

CCT	2000°K	2200°K	2500°K	2700°K	3000°K	3500°K	4000°K	4500°K	5000°K
LIGHT OUTPUT CONVERSION	0.68	0.74	0.82	0.96	1.0	1.0	1.0	1.01	1.1

3500°K LEDs are used for all photometric testing. To determine lumen outputs for other color temperatures, use the designated multiplier in the table above.

IES files for LED and extrusion options can be found on our website at [www.essentialLEDs.com](http://www.essentialLEDs.com). You'll find them on the "downloads" tab for each extrusion type.

## PHOTOMETRICS

VLT is proud of the extraordinary selection of fixture profiles and LED Boards we offer. This abundance of options makes presenting of Photometric data much better suited to our website. Please see [vltcorp.com](http://vltcorp.com) for all photometrics.





## FIXTURE LENGTH & WATTAGE TABLE - ML1, 1S, 4SL, 1QL, 1R, 2RL & 1EL

Use Code numbers below to specify fixture lengths for ML1, 1S, 4SL, 1QL, 1R, 2RL and 1EL extrusions.

A finished fixture length that differs from these lengths would be considered a Custom Length. Custom length fixtures have a finished length (including end caps) exactly as specified; an LED board that is the next size down is centered in the custom length fixture. Please contact factory for more information.

LED fixtures have a generous field angle, so a fixture does not need to extend the full length of a cabinet, shelf or display case for the area to be fully lit. Custom fixtures are most often used where the fixture is visible and an exact length is desired for aesthetic reasons. (Field Angle may be affected by lensing choice).

STANDARD PITCH FIXTURE LENGTHS (ML1, 1S, 4SL, 1QL, 1R, 2RL, 1EL)										
		STANDARD					HI CRI			ULTRA HI CRI
CODE	FINISHED FIXTURE	1720	2730	4740	5760	6760	3720	3740	3760	3790
4	4.72" [120mm]	0.6w	1.0w	1.2w	1.6w	2.2w	0.6w	1.2w	1.7w	2.3w
8	8.66" [220mm]	1.2w	1.9w	2.5w	3.3w	4.3w	1.2w	2.3w	3.5w	4.6w
12	12.60" [320mm]	1.8w	2.9w	3.7w	4.9w	6.5w	1.8w	3.5w	5.2w	6.9w
16	16.54" [420mm]	2.4w	3.9w	4.9w	6.5w	8.7w	2.3w	4.7w	6.9w	9.2w
20	20.47" [520mm]	3.0w	4.8w	6.2w	8.2w	10.8w	2.9w	5.8w	8.7w	11.5w
24	24.41" [620mm]	3.6w	5.8w	7.4w	9.8w	13.0w	3.5w	7.0w	10.4w	13.8w
28	28.35" [720mm]	4.2w	6.8w	8.6w	11.4w	15.2w	4.1w	8.2w	12.1w	16.1w
32	32.28" [820mm]	4.8w	7.7w	9.9w	13.1w	17.3w	4.7w	9.3w	13.9w	18.4w
36	36.22" [920mm]	5.4w	8.7w	11.1w	14.7w	19.5w	5.3w	10.5w	15.6w	20.7w
40	40.16" [1020mm]	6.0w	9.7w	12.3w	16.3w	21.7w	5.8w	11.7w	17.3w	23.0w
44	44.09" [1120mm]	6.6w	10.6w	13.6w	18.0w	23.8w	6.4w	12.8w	19.1w	25.3w
48	48.03" [1220mm]	7.2w	11.6w	14.8w	19.6w	26.0w	7.0w	14.0w	20.8w	27.6w
52	51.97" [1320mm]	7.8w	12.6w	16.0w	21.2w	28.2w	7.6w	15.2w	22.5w	29.9w
56	55.91" [1420mm]	8.4w	13.5w	17.3w	22.9w	30.3w	8.2w	16.3w	24.3w	32.2w
60	59.84" [1520mm]	9.0w	14.5w	18.5w	24.5w	32.5w	8.8w	17.5w	26.0w	34.5w
64	63.78" [1620mm]	9.6w	15.5w	19.7w	26.1w	34.7w	9.3w	18.7w	27.7w	36.8w
68	67.72" [1720mm]	10.2w	16.4w	21.0w	27.8w	36.8w	9.9w	19.8w	29.5w	39.1w
72	71.65" [1820mm]	10.8w	17.4w	22.2w	29.4w	39.0w	10.5w	21.0w	31.2w	41.4w
76	75.59" [1920mm]	11.4w	18.4w	23.4w	31.0w	41.2w	11.1w	22.2w	32.9w	43.7w
80	79.53" [2020mm]	12.0w	19.3w	24.7w	32.7w	43.3w	11.7w	23.3w	34.7w	46.0w
84	83.46" [2120mm]	12.6w	20.3w	25.9w	34.3w	45.5w	12.3w	24.5w	36.4w	48.3w
88	87.40" [2220mm]	13.2w	21.3w	27.1w	35.9w	47.7w	12.8w	25.7w	38.1w	50.6w
92	91.34" [2320mm]	13.8w	22.2w	28.4w	37.6w	49.8w	13.4w	26.8w	39.9w	52.9w
96	95.28" [2420mm]	14.4w	23.2w	29.6w	39.2w	52.0w	14.0w	28.0w	41.6w	55.2w

FIXTURE LENGTH & WATTAGE TABLE - 7SL, 8SL, 8CL, 8FL\*, 9SL, 3RL & 2QL

Use Code numbers below to specify fixture lengths for 7SL, 8SL, 8CL, 8FL\*, 9SL, 3RL & 2QL extrusions.

STANDARD PITCH FIXTURE LENGTHS FOR 7SL, 8SL, 8CL, 8FL*, 9SL, 3RL & 2QL EXTRUSIONS ONLY													
Add .25" [6.35mm] for 8FL		STANDARD					HI CRI			ULTRA HI CRI	DUAL		
CODE	FINISHED FIXTURE	1720	2730	4740	5760	6760	3720	3740	3760	3790	3760D	6760D	3790D
4	4.29" [109mm]	0.6w	1.0w	1.2w	1.6w	2.2w	0.6w	1.2w	1.7w	2.3w	3.5w	4.3w	4.6w
8	8.23" [209mm]	1.2w	1.9w	2.5w	3.3w	4.3w	1.2w	2.3w	3.5w	4.6w	6.9w	8.7w	9.2w
12	12.17" [309mm]	1.8w	2.9w	3.7w	4.9w	6.5w	1.8w	3.5w	5.2w	6.9w	10.4w	13.0w	13.8w
16	16.10" [409mm]	2.4w	3.9w	4.9w	6.5w	8.7w	2.3w	4.7w	6.9w	9.2w	13.9w	17.3w	18.4w
20	20.04" [509mm]	3.0w	4.8w	6.2w	8.2w	10.8w	2.9w	5.8w	8.7w	11.5w	17.3w	21.7w	23.0w
24	23.98" [609mm]	3.6w	5.8w	7.4w	9.8w	13.0w	3.5w	7.0w	10.4w	13.8w	20.8w	26.0w	27.6w
28	27.91" [709mm]	4.2w	6.8w	8.6w	11.4w	15.2w	4.1w	8.2w	12.1w	16.1w	24.3w	30.3w	32.2w
32	31.85" [809mm]	4.8w	7.7w	9.9w	13.1w	17.3w	4.7w	9.3w	13.9w	18.4w	27.7w	34.7w	36.8w
36	35.79" [909mm]	5.4w	8.7w	11.1w	14.7w	19.5w	5.3w	10.5w	15.6w	20.7w	31.2w	39.0w	41.4w
40	39.72" [1009mm]	6.0w	9.7w	12.3w	16.3w	21.7w	5.8w	11.7w	17.3w	23.0w	34.7w	43.3w	46.0w
44	43.66" [1109mm]	6.6w	10.6w	13.6w	18.0w	23.8w	6.4w	12.8w	19.1w	25.3w	38.1w	47.7w	50.6w
48	47.60" [1209mm]	7.2w	11.6w	14.8w	19.6w	26.0w	7.0w	14.0w	20.8w	27.6w	41.6w	52.0w	55.2w
52	51.54" [1309mm]	7.8w	12.6w	16.0w	21.2w	28.2w	7.6w	15.2w	22.5w	29.9w	45.1w	56.3w	59.8w
56	55.47" [1409mm]	8.4w	13.5w	17.3w	22.9w	30.3w	8.2w	16.3w	24.3w	32.2w	48.5w	60.7w	64.4w
60	59.41" [1509mm]	9.0w	14.5w	18.5w	24.5w	32.5w	8.8w	17.5w	26.0w	34.5w	52.0w	65.0w	69.0w
64	63.35" [1609mm]	9.6w	15.5w	19.7w	26.1w	34.7w	9.3w	18.7w	27.7w	36.8w	55.5w	69.3w	73.6w
68	67.28" [1709mm]	10.2w	16.4w	21.0w	27.8w	36.8w	9.9w	19.8w	29.5w	39.1w	58.9w	73.7w	78.2w
72	71.22" [1809mm]	10.8w	17.4w	22.2w	29.4w	39.0w	10.5w	21.0w	31.2w	41.4w	62.4w	78.0w	82.8w
76	75.16" [1909mm]	11.4w	18.4w	23.4w	31.0w	41.2w	11.1w	22.2w	32.9w	43.7w	65.9w	82.3w	87.4w
80	79.09" [2009mm]	12.0w	19.3w	24.7w	32.7w	43.3w	11.7w	23.3w	34.7w	46.0w	69.3w	86.7w	92.0w
84	83.03" [2109mm]	12.6w	20.3w	25.9w	34.3w	45.5w	12.3w	24.5w	36.4w	48.3w	72.8w	91.0w	96.6w
88	86.97" [2209mm]	13.2w	21.3w	27.1w	35.9w	47.7w	12.8w	25.7w	38.1w	50.6w	76.3w		
92	90.91" [2309mm]	13.8w	22.2w	28.4w	37.6w	49.8w	13.4w	26.8w	39.9w	52.9w	79.7w		
96	94.84" [2409mm]	14.4w	23.2w	29.6w	39.2w	52.0w	14.0w	28.0w	41.6w	55.2w	83.2w		
100	98.78" [2509mm]	15.0w	24.2w	30.8w	40.8w	54.2w	14.6w	29.2w	43.3w	57.5w	86.7w		
104	102.72" [2609mm]	15.6w	25.1w	32.1w	42.5w	56.3w	15.2w	30.3w	45.1w	59.8w	90.1w		
108	106.65" [2709mm]	16.2w	26.1w	33.3w	44.1w	58.5w	15.8w	31.5w	46.8w	62.1w			
112	110.59" [2809mm]	16.8w	27.1w	34.5w	45.7w	60.7w	16.3w	32.7w	48.5w	64.4w			
116	114.53" [2909mm]	17.4w	28.0w	35.8w	47.4w	62.8w	16.9w	33.8w	50.3w	66.7w			
120	118.47" [3009mm]	18.0w	29.0w	37.0w	49.0w	65.0w	17.5w	35.0w	52.0w	69.0w			
124	122.40" [3109mm]	18.6w	30.0w	38.2w	50.6w	67.2w	18.1w	36.2w	53.7w	71.3w			
128	126.34" [3209mm]	19.2w	30.9w	39.5w	52.3w	69.3w	18.7w	37.3w	55.5w	73.6w			
132	130.28" [3309mm]	19.8w	31.9w	40.7w	53.9w	71.5w	19.3w	38.5w	57.2w	75.9w			
136	134.21" [3409mm]	20.4w	32.9w	41.9w	55.5w	73.7w	19.8w	39.7w	58.9w	78.2w			
140	138.15" [3509mm]	21.0w	33.8w	43.2w	57.2w	75.8w	20.4w	40.8w	60.7w	80.5w			
144	142.09" [3609mm]	21.6w	34.8w	44.4w	58.8w	78.0w	21.0w	42.0w	62.4w	82.8w			
148	146.02" [3709mm]	22.2w	35.8w	45.6w	60.4w	80.2w	21.6w	43.2w	64.1w	85.1w			

\*For 8FL fixtures only, add 0.22" [5.6mm] to Finished Fixture Length for overall length including flange.

## FIXTURE LENGTH & WATTAGE TABLE - PITCHLESS LED BOARDS ONLY

Use Code numbers below to specify fixtures using Pitchless LED boards.

FIXTURE LENGTHS ML1, MLR, 1S, 4SL, 1QL, 1R, 2RL & 1EL											
CODE	FINISHED FIXTURE	PITCHLESS STANDARD			PITCHLESS HI CRI			ULTRA HI CRI	PITCHLESS DUAL COLOR	PITCHLESS NARROW FOCUS	
		5140	5160	5180	3140	3160	3180	3190	7180	5133	5163
4	4.65" [118mm]	0.7w	1.4w	2.3w	0.7w	1.4w	2.3w	2.3w	2.3w	1.1w	2.2w
8	8.50" [216mm]	1.5w	2.9w	4.6w	1.5w	2.9w	4.6w	4.6w	4.6w	2.3w	4.4w
12	12.36" [314mm]	2.2w	4.3w	6.9w	2.2w	4.3w	6.9w	6.9w	6.9w	3.4w	6.6w
16	16.22" [412mm]	2.9w	5.7w	9.2w	2.9w	5.7w	9.2w	9.2w	9.2w	4.5w	8.8w
20	20.07" [510mm]	3.7w	7.2w	11.5w	3.7w	7.2w	11.5w	11.5w	11.5w	5.7w	11.0w
24	23.94" [608mm]	4.4w	8.6w	13.8w	4.4w	8.6w	13.8w	13.8w	13.8w	6.8w	13.2w
28	27.80" [706mm]	5.1w	10.0w	16.1w	5.1w	10.0w	16.1w	16.1w	16.1w	7.9w	15.4w
32	31.65" [804mm]	5.9w	11.5w	18.4w	5.9w	11.5w	18.4w	18.4w	18.4w	9.1w	17.6w
36	35.51" [902mm]	6.6w	12.9w	20.7w	6.6w	12.9w	20.7w	20.7w	20.7w	10.2w	19.8w
40	39.37" [1000mm]	7.3w	14.3w	23.0w	7.3w	14.3w	23.0w	23.0w	23.0w	11.3w	22.0w
44	43.22" [1098mm]	8.1w	15.8w	25.3w	8.1w	15.8w	25.3w	25.3w	25.3w	12.5w	24.2w
48	47.08" [1196mm]	8.8w	17.2w	27.6w	8.8w	17.2w	27.6w	27.6w	27.6w	13.6w	26.4w
52	50.94" [1294mm]	9.6w	18.6w	29.9w	9.6w	18.6w	29.9w	29.9w	29.9w	14.7w	28.6w
56	54.80" [1392mm]	10.3w	20.0w	32.2w	10.3w	20.0w	32.2w	32.2w	32.2w	15.9w	30.8w
60	58.66" [1490mm]	11.0w	21.5w	34.5w	11.0w	21.5w	34.5w	34.5w	34.5w	17.0w	33.0w
64	62.51" [1588mm]	11.8w	22.9w	36.8w	11.8w	22.9w	36.8w	36.8w	36.8w	18.1w	35.2w
68	66.37" [1686mm]	12.5w	24.4w	39.1w	12.5w	24.4w	39.1w	39.1w	39.1w	19.3w	37.4w
72	70.23" [1784mm]	13.2w	25.8w	41.4w	13.2w	25.8w	41.4w	41.4w	41.4w	20.4w	39.6w
76	74.09" [1882mm]	13.9w	27.2w	43.7w	13.9w	27.2w	43.7w	43.7w	43.7w	21.5w	41.8w
80	77.95" [1980mm]	14.7w	28.7w	46.0w	14.7w	28.7w	46.0w	46.0w	46.0w	22.7w	44.0w
84	81.81" [2078mm]	15.5w	30.1w	48.3w	15.5w	30.1w	48.3w	48.3w	48.3w	23.8w	46.2w
88	85.67" [2176mm]	16.2w	31.5w	50.6w	16.2w	31.5w	50.6w	50.6w	50.6w	24.9w	48.4w
92	89.53" [2274mm]	16.9w	33.0w	52.9w	16.9w	33.0w	52.9w	52.9w	52.9w	26.1w	50.6w
96	93.39" [2372mm]	17.8w	34.4w	55.2w	17.8w	34.4w	55.2w	55.2w	55.2w	27.2w	52.8w

FIXTURE LENGTH & WATTAGE TABLE - PITCHLESS LED BOARDS ONLY

Use Code numbers below to specify fixtures using Pitchless LED boards.

FIXTURE LENGTHS 7SL, 8SL, 8CL, 8FL*, 9SL, 3RL & 2QL ONLY											
		PITCHLESS STANDARD			PITCHLESS HI CRI			ULTRA HI CRI	PITCHLESS DUAL COLOR	PITCHLESS NARROW FOCUS	
CODE	FINISHED FIXTURE	5140	5160	5180	3140	3160	3180	3190	7180	5133	5163
4	4.21" [107mm]	0.7w	1.4w	2.3w	0.7w	1.4w	2.3w	2.3w	2.3w	1.1w	2.2w
8	8.07" [205mm]	1.5w	2.9w	4.6w	1.5w	2.9w	4.6w	4.6w	4.6w	2.3w	4.4w
12	11.93" [303mm]	2.2w	4.3w	6.9w	2.2w	4.3w	6.9w	6.9w	6.9w	3.4w	6.6w
16	15.79" [401mm]	2.9w	5.7w	9.2w	2.9w	5.7w	9.2w	9.2w	9.2w	4.5w	8.8w
20	19.65" [499mm]	3.7w	7.2w	11.5w	3.7w	7.2w	11.5w	11.5w	11.5w	5.7w	11.0w
24	23.50" [597mm]	4.4w	8.6w	13.8w	4.4w	8.6w	13.8w	13.8w	13.8w	6.8w	13.2w
28	27.36" [695mm]	5.1w	10.0w	16.1w	5.1w	10.0w	16.1w	16.1w	16.1w	7.9w	15.4w
32	31.22" [793mm]	5.9w	11.5w	18.4w	5.9w	11.5w	18.4w	18.4w	18.4w	9.1w	17.6w
36	35.01" [891mm]	6.6w	12.9w	20.7w	6.6w	12.9w	20.7w	20.7w	20.7w	10.2w	19.8w
40	38.94" [989mm]	7.3w	14.3w	23.0w	7.3w	14.3w	23.0w	23.0w	23.0w	11.3w	22.0w
44	42.80" [1087mm]	8.1w	15.8w	25.3w	8.1w	15.8w	25.3w	25.3w	25.3w	12.5w	24.2w
48	46.65" [1185mm]	8.8w	17.2w	27.6w	8.8w	17.2w	27.6w	27.6w	27.6w	13.6w	26.4w
52	50.51" [1283mm]	9.6w	18.6w	29.9w	9.6w	18.6w	29.9w	29.9w	29.9w	14.7w	28.6w
56	54.37" [1381mm]	10.3w	20.0w	32.2w	10.3w	20.0w	32.2w	32.2w	32.2w	15.9w	30.8w
60	58.23" [1479mm]	11.0w	21.5w	34.5w	11.0w	21.5w	34.5w	34.5w	34.5w	17.0w	33.0w
64	62.01" [1577mm]	11.8w	22.9w	36.8w	11.8w	22.9w	36.8w	36.8w	36.8w	18.1w	35.2w
68	65.95" [1675mm]	12.5w	24.4w	39.1w	12.5w	24.4w	39.1w	39.1w	39.1w	19.3w	37.4w
72	69.80" [1773mm]	13.2w	25.8w	41.4w	13.2w	25.8w	41.4w	41.4w	41.4w	20.4w	39.6w
76	73.66" [1871mm]	13.9w	27.2w	43.7w	13.9w	27.2w	43.7w	43.7w	43.7w	21.5w	41.8w
80	77.52" [1969mm]	14.7w	28.7w	46.0w	14.7w	28.7w	46.0w	46.0w	46.0w	22.7w	44.0w
84	81.38" [2067mm]	15.5w	30.1w	48.3w	15.5w	30.1w	48.3w	48.3w	48.3w	23.8w	46.2w
88	85.24" [2165mm]	16.2w	31.5w	50.6w	16.2w	31.5w	50.6w	50.6w	50.6w	24.9w	48.4w
92	89.09" [2263mm]	16.9w	33.0w	52.9w	16.9w	33.0w	52.9w	52.9w	52.9w	26.1w	50.6w
96	92.95" [2361mm]	17.8w	34.4w	55.2w	17.8w	34.4w	55.2w	55.2w	55.2w	27.2w	52.8w
100	96.81" [2459mm]	18.3w	35.9w	57.5w	18.3w	35.9w	57.5w	57.5w	57.5w	28.3w	55.0w
104	100.67" [2557mm]	19.1w	37.3w	59.8w	19.1w	37.3w	59.8w	59.8w	59.8w	29.5w	57.2w
108	104.53" [2655mm]	19.8w	38.7w	62.1w	19.8w	38.7w	62.1w	62.1w	62.1w	30.6w	59.4w
112	108.39" [2753mm]	20.5w	40.1w	64.4w	20.5w	40.1w	64.4w	64.4w	64.4w	31.7w	61.6w
116	112.24" [2851mm]	21.3w	41.6w	66.7w	21.3w	41.6w	66.7w	66.7w	66.7w	32.9w	63.8w
120	116.10" [2949mm]	22.0w	43.0w	69.0w	22.0w	43.0w	69.0w	69.0w	69.0w	34.0w	66.0w
124	119.96" [3047mm]	22.7w	44.4w	71.3w	22.7w	44.4w	71.3w	71.3w	71.3w	35.1w	68.2w
128	123.82" [3145mm]	23.5w	45.9w	73.6w	23.5w	45.9w	73.6w	73.6w	73.6w	36.3w	70.4w
132	127.68" [3243mm]	24.2w	47.3w	75.9w	24.2w	47.3w	75.9w	75.9w	75.9w	37.4w	72.6w
136	131.54" [3341mm]	24.9w	48.7w	78.2w	24.9w	48.7w	78.2w	78.2w	78.2w	38.5w	74.8w
140	135.39" [3439mm]	25.7w	50.2w	80.5w	25.7w	50.2w	80.5w	80.5w	80.5w	39.7w	77.0w
144	139.25" [3537mm]	26.4w	51.6w	82.8w	26.4w	51.6w	82.8w	82.8w	82.8w	40.8w	79.2w
148	143.11" [3635mm]	27.1w	53.0w	85.1w	27.1w	53.0w	85.1w	85.1w	85.1w	41.9w	81.4w

\*For 8FL fixtures only, add 0.22" [5.6mm] to Finished Fixture Length for overall length including flange.

## FIXTURE LENGTH & WATTAGE TABLE - 5SLW




Use Code numbers below to specify finished fixture length.

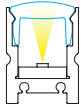
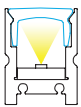
5SLW FIXTURE LENGTHS										
CODE	FINISHED FIXTURE	STANDARD					HI CRI			ULTRA HI CRI
		1720	2730	4740	5760	6760	3720	3740	3760	3790
4	5.36" [136mm]	0.6w	1.0w	1.2w	1.6w	2.2w	0.6w	1.2w	1.7w	2.3w
8	9.30" [236mm]	1.2w	0.0w	2.5w	3.3w	4.3w	1.2w	2.3w	3.5w	4.6w
12	13.23" [336mm]	1.8w	2.9w	3.7w	4.9w	6.5w	1.8w	3.5w	5.2w	6.9w
16	17.17" [436mm]	2.4w	3.9w	9.9w	6.5w	8.7w	2.3w	4.7w	6.9w	9.2w
20	21.11" [536mm]	3.0w	4.8w	6.2w	8.2w	10.8w	2.9w	5.8w	8.7w	11.5w
24	25.04" [636mm]	3.6w	5.8w	7.4w	9.8w	13.0w	3.5w	7.0w	10.4w	13.8w
28	28.98" [736mm]	4.2w	6.8w	8.6w	11.4w	15.2w	4.1w	8.2w	12.1w	16.1w
32	32.92" [836mm]	4.8w	7.7w	9.9w	13.1w	17.3w	4.7w	9.3w	13.9w	18.4w
36	36.86" [936mm]	5.4w	8.7w	11.1w	14.7w	19.5w	5.3w	10.5w	15.6w	20.7w
40	40.79" [1036mm]	6.0w	9.7w	12.3w	16.3w	21.7w	5.8w	11.7w	17.3w	23.0w
44	44.73" [1136mm]	6.6w	10.6w	13.6w	18.0w	23.8w	6.4w	12.8w	19.1w	25.3w
48	48.67" [1236mm]	7.2w	11.6w	14.8w	19.6w	26.0w	7.0w	14.0w	20.8w	27.6w
52	52.60" [1336mm]	7.8w	12.6w	16.0w	21.2w	28.2w	7.6w	15.2w	22.5w	29.9w
56	56.54" [1436mm]	8.4w	13.5w	17.3w	22.9w	30.3w	8.2w	16.3w	24.3w	32.2w
60	60.48" [1536mm]	13.4w	9.0w	14.5w	24.5w	32.5w	8.8w	17.5w	26.0w	34.5w
64	64.41" [1636mm]	9.6w	15.5w	19.7w	26.1w	34.7w	9.3w	18.7w	27.7w	36.8w
68	68.35" [1736mm]	10.2w	16.4w	21.0w	27.8w	36.8w	9.9w	19.8w	29.5w	39.1w
72	72.29" [1836mm]	10.8w	17.4w	22.2w	29.4w	39.0w	10.5w	21.0w	31.2w	41.4w

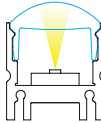
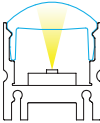
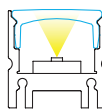
5SLW FIXTURE LENGTHS			
PITCHLESS Boards Only			
CODE	FINISHED FIXTURE	5133	5163
4	5.28" [134mm]	1.1w	2.2w
8	9.14" [232mm]	2.3w	4.4w
12	13.00" [330mm]	3.4w	6.6w
16	16.86" [428mm]	4.5w	8.8w
20	20.71" [526mm]	5.7w	11.0w
24	24.57" [624mm]	6.8w	13.2w
28	28.43" [722mm]	7.9w	15.4w
32	32.29" [820mm]	9.1w	17.6w
36	36.15" [918mm]	10.2w	19.8w
40	40.00" [1016mm]	11.3w	22.0w
44	43.86" [1114mm]	12.5w	24.2w
48	47.72" [1212mm]	13.6w	26.4w
52	51.58" [1310mm]	14.7w	28.6w
56	55.44" [1408mm]	15.9w	30.8w
60	59.30" [1506mm]	17.0w	33.0w
64	63.15" [1604mm]	18.1w	35.2w
68	67.01" [1702mm]	19.3w	37.4w
72	70.87" [1800mm]	20.4w	39.6w


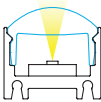
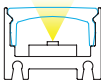


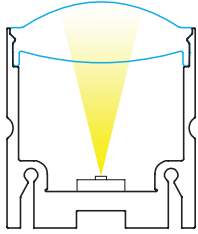
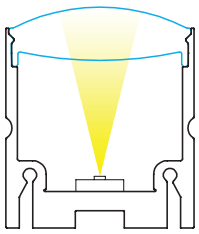
LENSING OPTIONS

2RL, 1QL - LENS BEAM ANGLES (FWHM)			
When Used With	Lens 2 (L2) "Bubble" Profile, Frosted	Lens 3 (L3) Flat Bottom, Frosted	Lens 4 (L4) Contour Profile, Frosted
			
Standard LED Boards	31°	48°	82°
Focus LED Boards (5133 or 5163)	18°	30°	78°

7SL - LENS BEAM ANGLES (FWHM)			
When Used With		Lens 3 (L3) "Bubble"	Lens 4 (L4) Contour Profile
			
Standard LED Boards		44°	76°
Focus LED Boards (5133 or 5163)		42°	65°

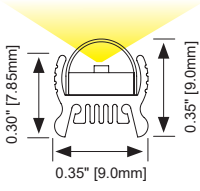
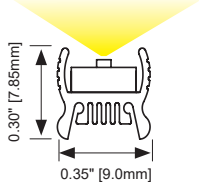
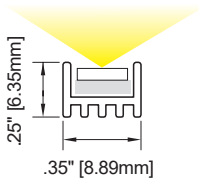
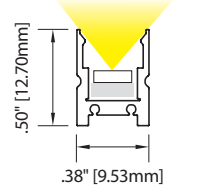
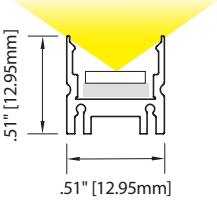
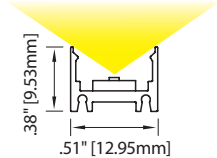
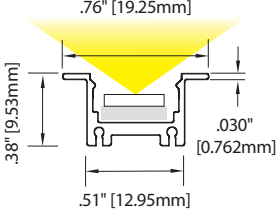
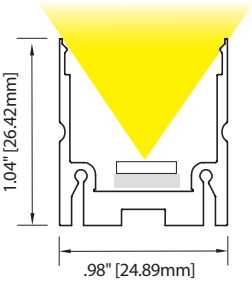
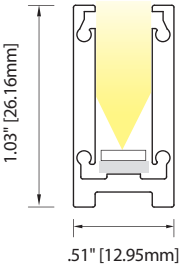
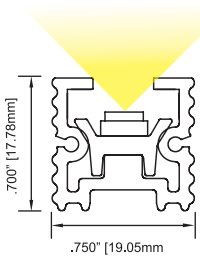
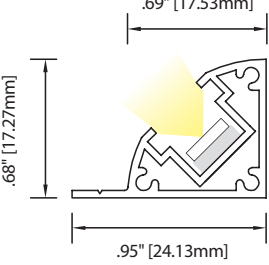
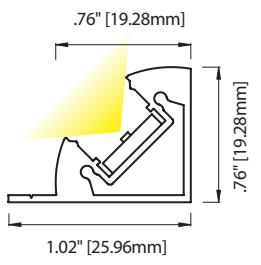
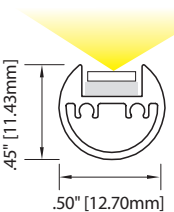
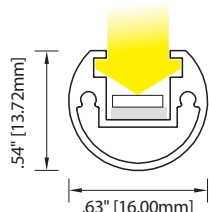
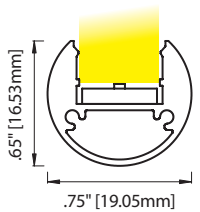
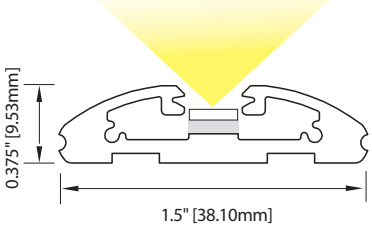
8SL, 2QL, 3RL - LENS BEAM ANGLES (FWHM)			
When Used With	Lens 2 (L2) "Bubble", Frosted Top Only	Lens 3 (L3) "Bubble", Frosted Top & Bottom	Lens 4 (L4) Contour Profile
			
Standard LED Boards	32°	51°	92°
Focus LED Boards (5133 or 5163)	26°	50°	89°

8CL, 8FL - LENS BEAM ANGLES (FWHM)			
When Used With	Lens 2 (L2) "Bubble", Frosted Top Only	Lens 3 (L3) "Bubble", Frosted Top & Bottom	Lens 4 (L4) Contour Profile
			
Standard LED Boards	44°	61°	92°
Focus LED Boards (5133 or 5163)	41°	58°	91°

9SL - LENS BEAM ANGLES (FWHM)		
When Used With	Lens 2 (L2) Pronounced "Bubble"	Lens 3 (L3) Medium "Bubble"
		
Standard LED Boards	12°	23°
Focus LED Boards (5133 or 5163)	12°	21°

\*Field angle for all lenses is greater than 120°

## LINEAR FIXTURE EXTRUSIONS

<b>Mini Lightrun</b> (0.042 lb/ft [0.0625 kg/m])	<b>ML1 - Mini Designer</b> (0.042 lb/ft [0.0625 kg/m])	<b>1S - Small Square</b> (0.0534 lb/ft [0.0795 kg/m])	<b>7SL - Small Square/Lensed</b> (0.0675 lb/ft [0.1003 kg/m])
			
<b>8SL - Medium Square/Lensed</b> (0.0925 lb/ft [0.1376 kg/m])	<b>8CL - Medium Square/Lensed</b> (0.0600 lb/ft [0.0893 kg/m])	<b>8FL - Medium Flanged/Lensed</b> (0.0925 lb/ft [0.1376 kg/m])	<b>9SL - Large Square/Lensed</b> (0.2750 lb/ft [0.4091 kg/m])
			
<b>4SL - Medium Square Tall/Lensed</b> (0.2955 lb/ft [0.4398 kg/m])	<b>5SLW - Square Extrusion</b> (0.3300 lb [0.4911 kg/m] per foot)	<b>1QL - Quarter Round/Lensed</b> (0.1899 lb/ft [0.2826 kg/m])	<b>2QL - Quarter Round/Lensed</b> (0.2300 lb/ft [0.3423 kg/m])
			
<b>1R - Small Round</b> (0.1026 lb/ft [0.1527 kg/m])	<b>2RL - Large Round/Lensed</b> (0.1623 lb/ft [0.2415 kg/m])	<b>3RL - Large Round/Lensed</b> (0.1700 lb/ft [0.2530 kg/m])	<b>1EL - Demi Ellipse/Lensed</b> (0.3300 lb/ft [0.4911 kg/m])
			

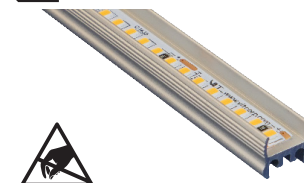




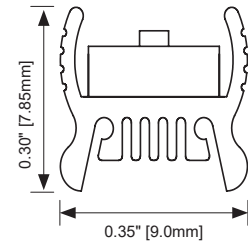
## ML1 MINI DESIGNER EXTRUSION - NO LENS

IP20 | Mini Rounded Designer extrusion for linear lighting applications. Includes Nichia LEDs in choice of 11 LED Board options. See lumen outputs, CCTs, wattage and other variables on Linear Fundamentals.

Available in Silver, Black or Bronze Anodized, White Powder Coated or Custom Finishes. Photometrics vary based on CCT; see linear fundamentals for conversion and other data specific to your fixture.



OBSERVE PRECAUTIONS FOR HANDLING ELECTROSTATIC SENSITIVE DEVICES



ELL- ML1 -

LED		CCT		Finish		Wire Exit		Listings & Options	
1720	260 lm/ft, 1.8 w/ft, 83 CRI	20	2000°K	AL	Silver Anodized	WE1	Default	UL	UL Listed
2730	397 lm/ft, 2.9 w/ft, 83 CRI	22	2200°K	BL	Black Anodized			CE	CE Listed (RoHS)
4740	528 lm/ft, 3.7 w/ft, 83 CRI	25	2500°K	BZ	Bronze Anodized			MAG	Magnetic Mount
5760	665 lm/ft, 4.9 w/ft, 83 CRI	27	2700°K	WH	White Powder Coat				
6760	875 lm/ft, 6.5 w/ft, 83 CRI	30	3000°K	C	Custom				
3720	223 lm/ft, 1.8 w/ft, 95 CRI	35	3500°K						
3740	430 lm/ft, 3.5 w/ft, 95 CRI	40	4000°K						
3760	609 lm/ft, 5.2 w/ft, 95 CRI	45	4500°K						
3790	621 lm/ft, 6.9 w/ft, 98 CRI <sup>1</sup>	50	5000°K						
5133	315 lm/ft, 3.4 w/ft, 87 CRI <sup>1</sup>								
5163	548 lm/ft, 6.6 w/ft, 87 CRI <sup>1</sup>								

Lens Options		Fixture Length	
NL	No Lens	See Fixture Length & Wattage Table; choose the correct Code number for the LED board and fixture length of your choice or specify Custom Length as follows: C (12.25") C [311mm]	

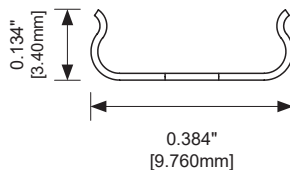
  

Color Legend	
Standard	Ultra HI CRI
HI CRI	Pitchless

<sup>1</sup> Not Available in 20K, 22K or 25K CCT

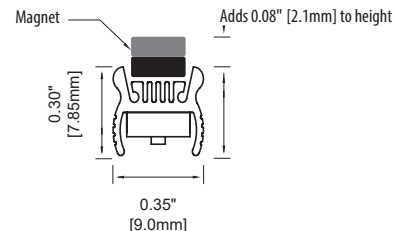
### Fixture Accessories

ELL - AC - MLR - MC



**Description:** Fixed Metal Clip for mounting ML1 extrusion. Screws to mounting surface with screw, provided. Fixture snaps into clip. Allow 1 per 12" of extrusion (min. 2 per fixture).

Factory Installed; See Options Above



**Description:** Magnetic Mount for ML1 extrusion. Small, strong magnets recess into rear side of fixture extrusions for magnetic mounting of fixture on suitable surface. Factory installed. Adds 0.08 [2.1mm] to fixture height.

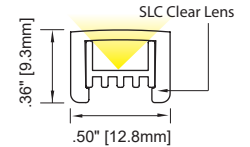
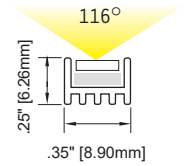
1S SMALL SQUARE EXTRUSION - OPTIONAL LENS

1S: IP20 | Small square extrusion for linear lighting applications. Includes Nichia LEDs in choice of 11 LED Board options. See lumen outputs, CCTs, wattage and other variables on Linear Fundamentals.

Available in Silver Anodized, Black Anodized or Custom Finishes. Photometrics vary based on CCT; see vltcorp.com for output conversion and other data specific to your fixture choices.



OBSERVE PRECAUTIONS FOR HANDLING ELECTROSTATIC SENSITIVE DEVICES



ELL- 1S -

LED		CCT		Finish		Lens Options		Wire Exit		Listings	
1720	260 lm/ft, 1.8 w/ft, 83 CRI	20	2000°K	AL	Silver Anodized	NL	No Lens	WE1	Default	UL	UL Listed
2730	397 lm/ft, 2.9 w/ft, 83 CRI	22	2200°K	BL	Black Anodized	SLC	Clear Lens <sup>2</sup>	C	Custom	CE	CE Marked (RoHS)
4740	528 lm/ft, 3.7 w/ft, 83 CRI	25	2500°K	C	Custom	<sup>2</sup> With Clear Lens, use ELL-AC-2SL-MC Fixed Metal Mounting Clip					
5760	665 lm/ft, 4.9 w/ft, 83 CRI	27	2700°K								
6760	875 lm/ft, 6.5 w/ft, 83 CRI	30	3000°K								
3720	223 lm/ft, 1.8 w/ft, 95 CRI	35	3500°K								
3740	430 lm/ft, 3.5 w/ft, 95 CRI	40	4000°K								
3760	609 lm/ft, 5.2 w/ft, 95 CRI	45	4500°K								
3790	621 lm/ft, 6.9 w/ft, 98 CRI <sup>1</sup>	50	5000°K								
5133	315 lm/ft, 3.4 w/ft, 87 CRI <sup>1</sup>										
5163	548 lm/ft, 6.6 w/ft, 87 CRI <sup>1</sup>										

Standard    Ultra HI CRI  
HI CRI    Pitchless

<sup>1</sup> Not Available in 20K, 22K or 25K CCT

Fixture Accessories

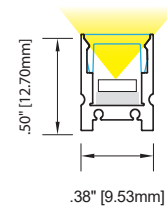
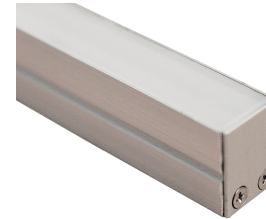
ELL - AC - 1S - MC	ELL - AC - 1S - AMC	ELL - AC - S123 - AB	ELL - AC - 2SL - MC
<b>Fixed Metal Mounting Clip.</b> Fixture with No Lens snaps into clip. Allow 1 per 12" (min. 2 per fixture). See Mounting Options.	<b>Adjustable Metal Mounting Clip.</b> Offset screws allow flush mounting. Bends to desired angle. Allow 1 per 12" (min. 2 per fixture). See Mounting Options.	<b>Adjustable Metal Bracket.</b> for use with Fixed Metal Mounting Clip (one bracket per clip). 30° adjustability. Raises fixture 3/8" (9.52mm). Bracket allows repeated angle adjustments, and easier angle adjustments in hard-to-reach areas like ceiling coves. See Mounting Options.	<b>Fixed Metal Mounting Clip.</b> Fixture with SLC Lens snaps into clip. Allow 1 per 12" (min. 2 per fixture). See Mounting Options.

## 7SL SMALL SQUARE EXTRUSION - EDGE TO EDGE LENS

7SL: IP54 | Small square extrusion for linear lighting applications. Slim extrusion wall (0.15") and edge-to-edge snap-in lensing for extra lumen output. UL Listed dry/damp. Includes Nichia LEDs in choice of 11 LED Board options. See lumen outputs, CCTs, wattage and other variables on Linear Fundamentals.

Available in Silver, Black or Custom Finishes. Opal 2 (Medium) or Opal 3 (Heavy) and 5133 or 5163 LED board required for full diffusion. Photometrics vary based on CCT and lensing; see vltcorp.com for conversion and other data specific to your fixture choices.

AVAILABLE IN LENGTHS UP TO 146.02" [3709MM]



ELL-7SL-

### LED

1720	260 lm/ft, 1.8 w/ft, 83 CRI
2730	397 lm/ft, 2.9 w/ft, 83 CRI
4740	528 lm/ft, 3.7 w/ft, 83 CRI
5760	665 lm/ft, 4.9 w/ft, 83 CRI
6760	875 lm/ft, 6.5 w/ft, 83 CRI
3720	223 lm/ft, 1.8 w/ft, 95 CRI
3740	430 lm/ft, 3.5 w/ft, 95 CRI
3760	609 lm/ft, 5.2 w/ft, 95 CRI
3790	621 lm/ft, 6.9 w/ft, 98 CRI <sup>1</sup>
5133	315 lm/ft, 3.4 w/ft, 87 CRI <sup>1</sup>
5163	548 lm/ft, 6.6 w/ft, 87 CRI <sup>1</sup>

### CCT

20	2000°K
22	2200°K
25	2500°K
27	2700°K
30	3000°K
35	3500°K
40	4000°K
45	4500°K
50	5000°K

### Finish

AL	Silver Anodized
BL	Black Anodized
C	Custom

### Lens Options

PG	Clear Acrylic
L3	Lens 3 (42° - 44°)
L4	Lens 4 (65° - 76°)
OP1	Opal 1, Frosted
OP2	Opal 2, Medium <sup>2</sup>
OP3	Opal 3, Heavy <sup>2</sup>

<sup>2</sup>Will provide full diffusion

### Wire Exit

WE1	Default
C	Custom

### Fixture Length

See Fixture Length and Wattage Table. Choose the correct Code number for the LED board and fixture length of your choice or specify Custom Length as follows: C (12.25") or C [311mm]

### Listings & Options

UL	UL Listed	
CE	CE Marked (RoHS)	
MAG	Magnetic Mount	

Standard HI CRI Ultra HI CRI Pitchless

<sup>1</sup>Not Available in 20K, 22K or 25K CCT

### Fixture Accessories

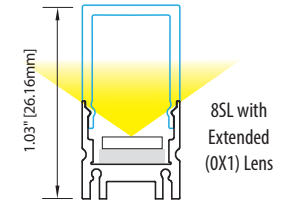
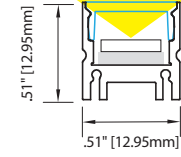
ELL - AC - 7SL - MC	ELL - AC - 7SL - AMC	ELL - AC - S123 - AB	Factory Installed; See Options Above
<b>Fixed Metal Mounting Clip.</b> Fixture extrusion snaps into clip. Allow 1 per 12" (min. 2 per fixture). See Mounting Options.	<b>Adjustable Metal Mounting Clip.</b> Offset screws allow flush mounting. Bends to desired angle. Allow 1 per 12" (min. 2 per fixture). See Mounting Options.	<b>Adjustable Metal Bracket</b> for use with Fixed Metal Mounting Clip (one bracket per clip). 30° adjustability. Raises fixture 3/8" (9.52mm). Bracket allows repeated angle adjustments, and easier angle adjustments in hard-to-reach areas like ceiling coves. See Mounting Options.	<b>Magnetic Mount</b> Small, strong, factory installed magnets recess into rear side of fixture extrusions for mounting of fixture onto suitable ferrous surface or accessory Steel Mounting Plates; 3 magnets per foot. Magnets protrude 0.08" [2.1mm] above rear surface of extrusion.

8SL MEDIUM SQUARE EXTRUSION - EDGE TO EDGE LENS

8SL: IP54 | Medium square extrusion for linear lighting applications. Slim extrusion wall (0.15") and edge-to-edge snap-in lensing for extra lumen output. UL Listed dry/damp. Includes Nichia LEDs in choice of 21 LED Board options. See lumen outputs, CCTs, wattage and other variables on Linear Fundamentals.

Available in Silver, Black or Bronze Anodized, White Powder Coated, or Custom Finishes. Photometrics vary based on CCT and lensing; see vltcorp.com for conversion and other data specific to your fixture choices.

AVAILABLE IN LENGTHS UP TO 146.02" [3709MM]



ELL-8SL - \_\_\_\_\_

	LED	CCT	Finish	Lens Options	Wire Exit	Listings & Options		
STANDARD PITCH	1720	260 lm/ft, 1.8 w/ft, 83+ CRI	20	2000°K	AL Silver Anodized	PG Clear Acrylic	WE1 Default	UL UL Listed
	2730	397 lm/ft, 2.9 w/ft, 83+ CRI	22	2200°K	BL Black Anodized	L2 Lens 2 (26° - 32°)	C Custom	CE CE Marked (RoHS)
	4740	528 lm/ft, 3.7 w/ft, 83+ CRI	25	2500°K	BZ Bronze Anodized	L3 Lens 3 (50° - 51°)	MAG Magnetic Mount	
	5760	665 lm/ft, 4.9 w/ft, 83+ CRI	27	2700°K	WH White Powder Coat	L4 Lens 4 (89° - 92°)		
	6760	875 lm/ft, 6.5 w/ft, 83+ CRI	30	3000°K	C Custom	OP1 Opal 1, Frosted		
	3720	223 lm/ft, 1.8 w/ft, 95+ CRI	35	3500°K		OP2 Opal 2, Medium		
	3740	430 lm/ft, 3.5 w/ft, 95+ CRI	40	4000°K	OP3 Opal 3, Heavy			
	3760	609 lm/ft, 5.2 w/ft, 95+ CRI	45	4500°K	OX1 Ext. Lens, Opal 1			
	3790	621 lm/ft, 6.9 w/ft, 98 CRI <sup>1</sup>	50	5000°K				
	PITCHLESS	5140	287 lm/ft, 2.2 w/ft, 83+ CRI	20/30	2000°K/ 3000°K <sup>2</sup>			
		5160	571 lm/ft, 4.3 w/ft, 83+ CRI	25/40	2500°K/ 4000°K <sup>2</sup>			
		5180	920 lm/ft, 6.9 w/ft, 83+ CRI	30/40	3000°K/ 4000°K <sup>2</sup>			
3140		237 lm/ft, 2.2 w/ft, 95+ CRI	35/45	3500°K/ 4500°K <sup>2</sup>				
3160		469 lm/ft, 4.3 w/ft, 95+ CRI						
3180		773 lm/ft, 6.9 w/ft, 95+ CRI						
3150		202 lm/ft, 2.2 w/ft, 98 CRI <sup>1</sup>						
3170		404 lm/ft, 3.9 w/ft, 98 CRI <sup>1</sup>						
3190		710 lm/ft, 6.9 w/ft, 98 CRI <sup>1</sup>						
7180		750 lm/ft, 6.9 w/ft, 83+/95+ CRI <sup>2</sup>						
5133		315 lm/ft, 3.4 w/ft, 87 CRI <sup>1</sup>						
5163		548 lm/ft, 6.6 w/ft, 87 CRI <sup>1</sup>						

■ Standard     ■ HI CRI     ■ Pitchless/Standard  
■ Pitchless/Hi CRI     ■ Pitchless/Dual Color  
■ Pitchless/Narrow Focus     ■ Ultra HI CRI

<sup>1</sup> Not Available in 20K, 22K or 25K CCT

<sup>2</sup> 7180 Boards Only: CRI Varies Based on CCT Combination

**Fixture Length**  
 See Fixture Length and Wattage Table. Choose the correct Code number for the LED board and fixture length of your choice or specify Custom Length as follows: C (12.25") or C [311mm]

Fixture Accessories



**Fixed Metal Mounting Clip.** Fixture extrusion snaps into clip. Allow 1 per 12" (min. 2 per fixture). See Mounting Options.

**Adjustable Metal Mounting Clip** Offset screws allow flush mounting. Bends to desired angle. Allow 1 per 12" (min. 2 per fixture). See Mounting Options.

**Adjustable Metal Bracket** for use with Fixed Metal Mounting Clip (one bracket per clip). 30° adjustability. Raises fixture 3/8" (9.52mm). Bracket allows repeated angle adjustments, and easier angle adjustments in hard-to-reach areas like ceiling covers. See Mounting Options.

**Magnetic Mount** Small, strong, factory installed magnets recess into rear side of fixture extrusions for mounting of fixture onto suitable ferrous surface or accessory Steel Mounting Plates. 3 magnets per foot. Magnets protrude 0.09" [2.3mm] above rear surface of extrusion.

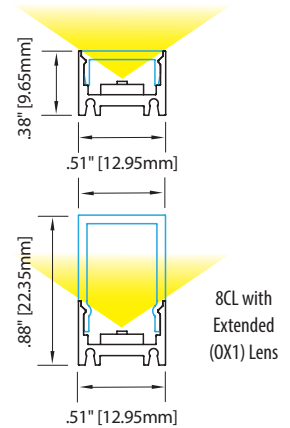
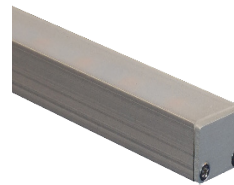


## 8CL MEDIUM SQUARE COMPACT EXTRUSION - EDGE TO EDGE LENS

8CL: IP54 | Compact medium square extrusion for linear lighting applications. Slim extrusion wall (0.15") and edge-to-edge snap-in lensing for extra lumen output. UL Listed dry/damp. Includes Nichia LEDs in choice of 21 LED Board options. See lumen outputs, CCTs, wattage and other variables on Linear Fundamentals.

Available in Silver, Black or Bronze Anodized, White Powder Coated, or Custom Finishes. Photometrics vary based on CCT and lensing; see vltcorp.com for conversion and other data specific to your fixture choices.

AVAILABLE IN LENGTHS UP TO 146.02" [3709MM]



### ELL- 8CL -

	LED	CCT	Finish	Lens Options	Wire Exit	Listings & Options							
STANDARD PITCH	1720	260 lm/ft, 1.8 w/ft, 83+ CRI	20	2000°K	AL	Silver Anodized	PG	Clear Acrylic	WE1	Default	UL	UL Listed	UL US
	2730	397 lm/ft, 2.9 w/ft, 83+ CRI	22	2200°K	BL	Black Anodized	L2	Lens 2 (41° - 44°)	C	Custom	CE	CE Marked (RoHS)	CE
	4740	528 lm/ft, 3.7 w/ft, 83+ CRI	25	2500°K	BZ	Bronze Anodized	L3	Lens 3 (58° - 61°)			MAG	Magnetic Mount	
	5760	665 lm/ft, 4.9 w/ft, 83+ CRI	27	2700°K	WH	White Powder Coat	L4	Lens 4 (91° - 92°)					
	6760	875 lm/ft, 6.5 w/ft, 83+ CRI	30	3000°K	C	Custom	OP1	Opal 1, Frosted					
	3720	223 lm/ft, 1.8 w/ft, 95+ CRI	35	3500°K			OP2	Opal 2, Medium					
	3740	430 lm/ft, 3.5 w/ft, 95+ CRI	40	4000°K			OP3	Opal 3, Heavy					
	3760	609 lm/ft, 5.2 w/ft, 95+ CRI	45	4500°K			OX1	Ext. Lens, Opal 1					
	3790	621 lm/ft, 6.9 w/ft, 98 CRI <sup>1</sup>	50	5000°K									
	PITCHLESS	5140	287 lm/ft, 2.2 w/ft, 83+ CRI	20/30	2000°K/ 3000°K <sup>2</sup>								
5160		571 lm/ft, 4.3 w/ft, 83+ CRI	25/40	2500°K/ 4000°K <sup>2</sup>									
5180		920 lm/ft, 6.9 w/ft, 83+ CRI	30/40	3000°K/ 4000°K <sup>2</sup>									
3140		237 lm/ft, 2.2 w/ft, 95+ CRI	35/45	3500°K/ 4500°K <sup>2</sup>									
3160		469 lm/ft, 4.3 w/ft, 95+ CRI											
3180		773 lm/ft, 6.9 w/ft, 95+ CRI											
3150		202 lm/ft, 2.2 w/ft, 98 CRI <sup>1</sup>											
3170		404 lm/ft, 3.9 w/ft, 98 CRI <sup>1</sup>											
3190		710 lm/ft, 6.9 w/ft, 98 CRI <sup>1</sup>											
7180		750 lm/ft, 6.9 w/ft, 83+/95+ CRI <sup>2</sup>											
5133		315 lm/ft, 3.4 w/ft, 87 CRI <sup>1</sup>											
5163	548 lm/ft, 6.6 w/ft, 87 CRI <sup>1</sup>												

**Fixture Length**  
See Fixture Length and Wattage Table. Choose the correct Code number for the LED board and fixture length of your choice or specify Custom Length as follows: C (12.25") or C [311mm]

- Standard
- HI CRI
- Pitchless/Standard
- Pitchless/Hi CRI
- Pitchless/Dual Color
- Pitchless/Narrow Focus
- Ultra HI CRI

<sup>1</sup> Not Available in 20K, 22K or 25K CCT  
<sup>2</sup> 7180 Boards Only: CRI Varies Based on CCT Combination

### Fixture Accessories



**Fixed Metal Mounting Clip.** Fixture extrusion snaps into clip. Allow 1 per 12" (min. 2 per fixture). See Mounting Options.

**Adjustable Metal Mounting Clip** Offset screws allow flush mounting. Bends to desired angle. Allow 1 per 12" (min. 2 per fixture). See Mounting Options.

**Adjustable Metal Bracket** for use with Fixed Metal Mounting Clip (one bracket per clip). 30° adjustability. Raises fixture 3/8" (9.52mm). Bracket allows repeated angle adjustments, and easier angle adjustments in hard-to-reach areas like ceiling covers. See Mounting Options.

**Magnetic Mount** Small, strong, factory installed magnets recess into rear side of fixture extrusions for mounting of fixture onto suitable ferrous surface or accessory Steel Mounting Plates. 3 magnets per foot. Magnets protrude 0.09" [2.3mm] above rear surface of extrusion.

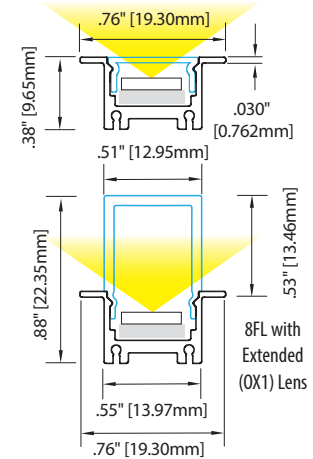


8FL MEDIUM SQUARE FLANGED EXTRUSION - EDGE TO EDGE LENS

8FL: IP54 | Flanged medium square extrusion for linear lighting applications in millwork. Slim extrusion wall (0.15") and edge-to-edge snap-in lensing for extra lumen output; flange extends .125" [3.175mm] from sides and ends of fixture. Install using Magnet Accessory or glue directly into millwork. UL Listed dry/damp. Includes Nichia LEDs in choice of 21 LED Board options. See lumen outputs, CCTs, wattage and other variables on Linear Fundamentals.

Available in Silver, Black or Bronze Anodized, White Powder Coated, or Custom Finishes. Photometrics vary based on CCT and lensing; see vltcorp.com for conversion and other data specific to your fixture choices.

AVAILABLE IN LENGTHS UP TO 146.02" [3709MM]



ELL- 8FL -

	LED	CCT	Finish	Lens Options	Wire Exit	Listings & Options		
STANDARD PITCH	1720	260 lm/ft, 1.8 w/ft, 83+ CRI	20	2000°K	AL Silver Anodized	PG Clear Acrylic	WE1 Default	UL UL Listed
	2730	397 lm/ft, 2.9 w/ft, 83+ CRI	22	2200°K	BL Black Anodized	L2 Lens 2 (41° - 44°)	C Custom	CE CE Marked (RoHS)
	4740	528 lm/ft, 3.7 w/ft, 83+ CRI	25	2500°K	BZ Bronze Anodized	L3 Lens 3 (58° - 61°)	MAG Magnetic Mount	
	5760	665 lm/ft, 4.9 w/ft, 83+ CRI	27	2700°K	WH White Powder Coat	L4 Lens 4 (91° - 92°)		
	6760	875 lm/ft, 6.5 w/ft, 83+ CRI	30	3000°K	C Custom	OP1 Opal 1, Frosted		
	3720	223 lm/ft, 1.8 w/ft, 95+ CRI	35	3500°K		OP2 Opal 2, Medium		
	3740	430 lm/ft, 3.5 w/ft, 95+ CRI	40	4000°K		OP3 Opal 3, Heavy		
	3760	609 lm/ft, 5.2 w/ft, 95+ CRI	45	4500°K		OX1 Ext. Lens, Opal 1		
	3790	621 lm/ft, 6.9 w/ft, 98 CRI <sup>1</sup>	50	5000°K				
	PITCHLESS	5140	287 lm/ft, 2.2 w/ft, 83+ CRI	20/30	2000°K/ 3000°K <sup>2</sup>			
5160		571 lm/ft, 4.3 w/ft, 83+ CRI	25/40	2500°K/ 4000°K <sup>2</sup>				
5180		920 lm/ft, 6.9 w/ft, 83+ CRI	30/40	3000°K/ 4000°K <sup>2</sup>				
3140		237 lm/ft, 2.2 w/ft, 95+ CRI	35/45	3500°K/ 4500°K <sup>2</sup>				
3160		469 lm/ft, 4.3 w/ft, 95+ CRI						
3180		773 lm/ft, 6.9 w/ft, 95+ CRI						
3150		202 lm/ft, 2.2 w/ft, 98 CRI <sup>1</sup>						
3170		404 lm/ft, 3.9 w/ft, 98 CRI <sup>1</sup>						
3190		710 lm/ft, 6.9 w/ft, 98 CRI <sup>1</sup>						
7180		750 lm/ft, 6.9 w/ft, 83+/95+ CRI <sup>2</sup>						
5133		315 lm/ft, 3.4 w/ft, 87 CRI <sup>1</sup>						
5163	548 lm/ft, 6.6 w/ft, 87 CRI <sup>1</sup>							

■ Standard    ■ HI CRI    ■ Pitchless/Standard  
■ Pitchless/Hi CRI    ■ Pitchless/Dual Color  
■ Pitchless/Narrow Focus    ■ Ultra HI CRI

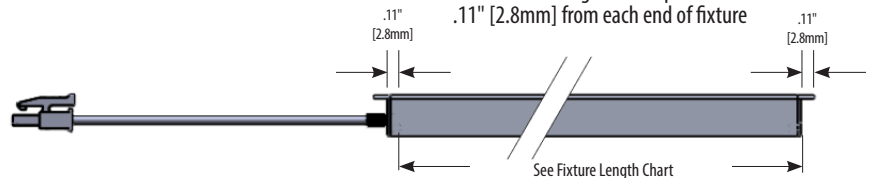
<sup>1</sup> Not Available in 20K, 22K or 25K CCT  
<sup>2</sup> 7180 Boards Only: CRI Varies Based on CCT Combination

Wire Exit	Default
WE1	Default
C	Custom

Fixture Length

See Fixture Length and Wattage Table. Choose the correct Code number for the LED board and fixture length of your choice or specify Custom Length as follows: C (12.25") or C [311mm]

8FL fixture uses flanged end caps that extends .11" [2.8mm] from each end of fixture



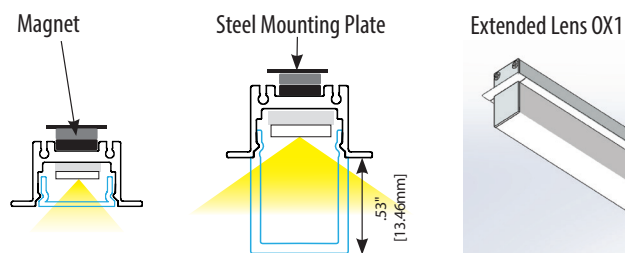
Fixture Accessories

Factory Installed; See Options Above	ELL - AC - 2SL - MC

**Magnetic Mount** Small, strong, factory installed magnets recess into rear side of fixture extrusions for mounting fixture onto suitable ferrous surface or accessory Steel Mounting Plates (see Mounting Options); 3 magnets per foot. Magnets protrude 0.09" [2.3mm] above rear surface of extrusion.

**Fixed Metal Mounting Clip.** Fixture extrusion snaps into clip. Allow 1 per 12" (min. 2 per fixture). See Mounting Options.

The 8FL fixture is intended primarily for use in shelves or millwork, where the flange provides a clean, self-trimming finish. Fixtures can be installed in routed channels with Magnets and Steel Mounting Plates, or glued directly into millwork. Flat lenses provide an installation flush with mounting surface, Extended Lenses (OX1) protrude .53" from mounting surface.



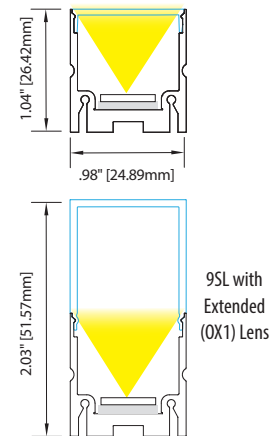
## 9SL LARGE SQUARE EXTRUSION - EDGE TO EDGE LENS

9SL: IP54 | Large square extrusion for linear lighting applications. Slim extrusion wall (0.15") and edge-to-edge snap-in lensing for extra lumen output. UL Listed dry/damp. Includes Nichia LEDs in choice of 22 LED Board options. See lumen outputs, CCTs, wattage and other variables on Linear Fundamentals.

For maximum lumen output, choose Dual Row 3760D or 6760D LED boards. For variable white with separate controls, specify two rows of any LED board (i.e. "2 x 3720") and specify two CCTs (i.e. "22/40").

Available in Silver, Black or Bronze Anodized, White Powder Coated, or Custom Finishes. Photometrics vary based on CCT and lensing; see vltcorp.com for conversion and other data specific to your fixture choices.

AVAILABLE IN LENGTHS UP TO 146.02" [3709MM]



ELL-9SL -

	LED	CCT	Finish	Lens Options	Wire Exit	Listings & Options		
STANDARD PITCH	1720	260 lm/ft, 1.8 w/ft, 83+ CRI	20	2000°K	AL Silver Anodized	PG Clear Acrylic	WE1 Default	UL UL Listed
	2730	397 lm/ft, 2.9 w/ft, 83+ CRI	22	2200°K	BL Black Anodized	L2 Lens 2 (12°)	C Custom	CE CE Marked (RoHS)
	4740	528 lm/ft, 3.7 w/ft, 83+ CRI	25	2500°K	BZ Bronze Anodized	L3 Lens 3 (21° - 23°)		MAG Magnetic Mount
	5760	665 lm/ft, 4.9 w/ft, 83+ CRI	27	2700°K	WH White Powder Coat	OP1 Opal 1, Frosted		
	6760	875 lm/ft, 6.5 w/ft, 83+ CRI	30	3000°K	C Custom	OP2 Opal 2, Medium		
	3720	223 lm/ft, 1.8 w/ft, 95+ CRI	35	3500°K		OP3 Opal 3, Heavy		
	3740	430 lm/ft, 3.5 w/ft, 95+ CRI	40	4000°K		OX1 Ext. Lens, Opal 1		
	3760	609 lm/ft, 5.2 w/ft, 95+ CRI	45	4500°K				
	3790	621 lm/ft, 6.9 w/ft, 98 CRI <sup>1</sup>	50	5000°K				
	3760D	1218 lm/ft, 10.4 w/ft, 95+ CRI	20/30	2000°K/ 3000°K <sup>2</sup>				
	6760D	1750 lm/ft, 13.0 w/ft, 83+ CRI	25/40	2500°K/ 4000°K <sup>2</sup>				
3790D	1242 lm/ft, 13.8 w/ft, 98 CRI	30/40	3000°K/ 4000°K <sup>2</sup>					
PITCHLESS	5140	287 lm/ft, 2.2 w/ft, 83+ CRI	35/45	3500°K/ 4500°K <sup>2</sup>				
	5160	571 lm/ft, 4.3 w/ft, 83+ CRI						
	5180	920 lm/ft, 6.9 w/ft, 83+ CRI						
	3140	237 lm/ft, 2.2 w/ft, 95+ CRI						
	3160	469 lm/ft, 4.3 w/ft, 95+ CRI						
	3180	773 lm/ft, 6.9 w/ft, 95+ CRI						
	3150	202 lm/ft, 2.2 w/ft, 98 CRI <sup>1</sup>						
	3170	404 lm/ft, 3.9 w/ft, 98 CRI <sup>1</sup>						
	3190	710 lm/ft, 6.9 w/ft, 98 CRI <sup>1</sup>						
	7180	750 lm/ft, 6.9 w/ft, 83+/95+ CRI <sup>2</sup>						

■ Standard    ■ HI CRI    ■ Dual Rows  
■ Pitchless/Standard    ■ Pitchless/Hi CRI  
■ Pitchless/Dual Color    ■ Ultra HI CRI

<sup>1</sup> Not Available in 20K, 22K or 25K CCT  
<sup>2</sup> 7180 Boards Only: CRI Varies Based on CCT Combination

**Wire Exit**

WE1 Default  
C Custom

**Fixture Length**

See Fixture Length and Wattage Table. Choose the correct Code number for the LED board and fixture length of your choice or specify Custom Length as follows: C (12.25") or C [311mm]

### Fixture Accessories

ELL - AC - 9SL - MC	ELL - AC - 9SL - AMC	ELL - AC - S123 - AB	ELL - AC - 9SL - WCR - AL	Factory Installed; See Options Above

**Fixed Metal Mounting Clip.** Fixture extrusion snaps into clip. Allow 1 per 12" (min. 2 per fixture). See Mounting Options.

**Adjustable Metal Mounting Clip.** Offset screws allow flush mounting. Bends to desired angle. Allow 1 per 12" (min. 2 per fixture). See Mounting Options.

**Adjustable Metal Bracket** for use with Fixed Metal Mounting Clip (one bracket per clip). 30° adjustability. Raises fixture 3/8" (9.52mm). Bracket allows repeated angle adjustments, and easier angle adjustments in hard-to-reach areas like ceiling coves. See Mounting Options.

**Wall / Ceiling Mounting Rough-in;** Specify length to match fixture length. 8-32 flat head screw allows height adjustment for flush installation. (Not walk-over or drive-over rated). See Mounting Options.

**Magnetic Mount** Small, strong, factory installed magnets recess into rear side of fixture extrusions for mounting of fixture onto suitable ferrous surface or accessory Steel Mounting Plates; 3 magnets per foot. See Mounting Options.

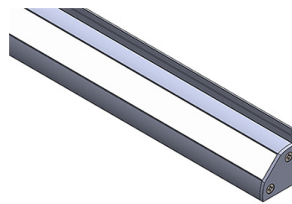




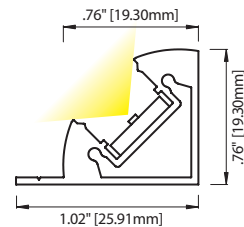
## 2QL QUARTER ROUND EXTRUSION - LENSED

2QL: IP40 | Quarter Round extrusion fits snugly into corners for bright, even linear lighting. UL Listed dry/damp. Includes Nichia LEDs in choice of 21 LED Board options. See lumen outputs, CCTs, wattage and other variables on Linear Fundamentals.

Available in Silver, Black or Bronze Anodized, White Powder Coated, or Custom Finishes. Choice of Clear Acrylic lens (standard), 3 Opal diffusion lenses, or three focusing lenses L2 (18° - 31°), L3 (30° - 42°) or Lens 4 (78° - 82°). Photometrics vary based on CCT and lensing; see vltcorp.com for output conversion and other data specific to your fixture choices.



(Beam Angle based on 2QL fixture with Clear Acrylic lens)



### ELL- 2QL -

	LED	CCT	Finish	Lens Options	Wire Exit	Listings & Options							
STANDARD PITCH	1720	260 lm/ft, 1.8 w/ft, 83+ CRI	20	2000°K	AL Silver Anodized	PG Clear Acrylic	<table border="1"> <tr> <td>UL</td> <td>UL Listed</td> <td>cULus</td> </tr> <tr> <td>CE</td> <td>CE Marked (RoHS)</td> <td>CE</td> </tr> </table>	UL	UL Listed	cULus	CE	CE Marked (RoHS)	CE
	UL	UL Listed	cULus										
	CE	CE Marked (RoHS)	CE										
	2730	397 lm/ft, 2.9 w/ft, 83+ CRI	22	2200°K	BL Black Anodized	L2 Lens 2 (26° - 32°)							
	4740	528 lm/ft, 3.7 w/ft, 83+ CRI	25	2500°K	BZ Bronze Anodized	L3 Lens 3 (50° - 51°)							
	5760	665 lm/ft, 4.9 w/ft, 83+ CRI	27	2700°K	WH White Powder Coat	L4 Lens 4 (89° - 92°)							
	6760	875 lm/ft, 6.5 w/ft, 83+ CRI	30	3000°K	C Custom	OP1 Opal 1, Frosted							
	3720	223 lm/ft, 1.8 w/ft, 95+ CRI	35	3500°K		OP2 Opal 2, Medium							
	3740	430 lm/ft, 3.5 w/ft, 95+ CRI	40	4000°K		OP3 Opal 3, Heavy							
	3760	609 lm/ft, 5.2 w/ft, 95+ CRI	45	4500°K									
3790	621 lm/ft, 6.9 w/ft, 98 CRI <sup>1</sup>	50	5000°K										
PITCHLESS	5140	287 lm/ft, 2.2 w/ft, 83+ CRI	20/30	2000°K/ 3000°K <sup>2</sup>									
	5160	571 lm/ft, 4.3 w/ft, 83+ CRI	25/40	2500°K/ 4000°K <sup>2</sup>									
	5180	920 lm/ft, 6.9 w/ft, 83+ CRI	30/40	3000°K/ 4000°K <sup>2</sup>									
	3140	237 lm/ft, 2.2 w/ft, 95+ CRI	35/45	3500°K/ 4500°K <sup>2</sup>									
	3160	469 lm/ft, 4.3 w/ft, 95+ CRI											
	3180	773 lm/ft, 6.9 w/ft, 95+ CRI											
	3150	202 lm/ft, 2.2 w/ft, 98 CRI <sup>1</sup>											
	3170	404 lm/ft, 3.9 w/ft, 98 CRI <sup>1</sup>											
	3190	710 lm/ft, 6.9 w/ft, 98 CRI <sup>1</sup>											
	7180	750 lm/ft, 6.9 w/ft, 83+/95+ CRI <sup>2</sup>											
	5133	315 lm/ft, 3.4 w/ft, 87 CRI <sup>1</sup>											
5163	548 lm/ft, 6.6 w/ft, 87 CRI <sup>1</sup>												

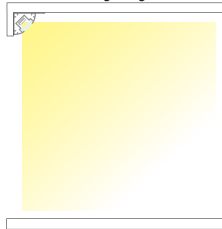
### Fixture Length

See Fixture Length and Wattage Table. Choose the correct Code number for the LED board and fixture length of your choice or specify Custom Length as follows: C (12.25") or C [311mm]

- Standard
- HI CRI
- Pitchless/Standard
- Pitchless/Hi CRI
- Pitchless/Dual Color
- Pitchless/Narrow Focus
- Ultra HI CRI

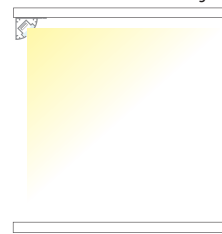
<sup>1</sup> Not Available in 20K, 22K or 25K CCT  
<sup>2</sup> 7180 Boards Only: CRI Varies Based on CCT Combination

2QL tucked behind lighting valance

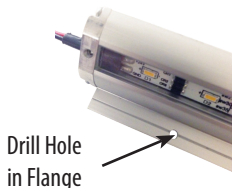


2QL's self-contained mounting flange allows the fixture to fit tightly into corners, with a 94° beam angle and wide field angle for fully lighting shelf and undercabinet spaces. 2QL can tuck neatly behind a lighting valance, as illustrated at left, or if no valance is provided, 2QL can mount flush with the front edge of the shelf or cabinet. The fixture's slim, finished back surface ensures an attractive presentation, as shown in the photos to the right. With black, white, silver, bronze or custom finish options, 2QL can blend in with or accent a wide range of cabinetry finishes.

2QL mounted on shelf edge



When visible, the slim 2QL fixture adds an attractive accent to cabinetry



Drill Hole in Flange

The 2QL flange is scored for easy drilling; mounting holes should be drilled approximately every 20" (minimum two holes per fixture). The 2QL fixture can also be mounted using VHB tape.



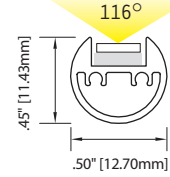
1R SMALL ROUND EXTRUSION - NO LENS

1R: IP20 | Round extrusion for linear lighting applications. Includes Nichia LEDs in choice of 11 LED Board options. See lumen outputs, CCTs, wattage and other variables on Linear Fundamentals.

Available in Silver, Black or Bronze Anodized, White Powder Coated, or Custom Finishes. No lens. Photometrics vary based on CCT; see vltcorp.com for output conversion and other data specific to your fixture choices.



OBSERVE PRECAUTIONS FOR HANDLING ELECTROSTATIC SENSITIVE DEVICES



ELL- 1R -

LED		CCT		Finish		Lens Options		Wire Exit		Listings & Options	
1720	260 lm/ft, 1.8 w/ft, 83 CRI	20	2000°K	AL	Silver Anodized	NL	No Lens	WE1	Default	UL	UL Listed
2730	397 lm/ft, 2.9 w/ft, 83 CRI	22	2200°K	BL	Black Anodized			C	Custom	CE	CE Marked (RoHS)
4740	528 lm/ft, 3.7 w/ft, 83 CRI	25	2500°K	BZ	Bronze Anodized					IM	Inside Mount End Caps <sup>2</sup>
5760	665 lm/ft, 4.9w/ft, 83CRI	27	2700°K	WH	White Powder Coat					EM8	8mm End Mount Leg <sup>2</sup>
6760	875 lm/ft, 6.5w/ft, 83 CRI	30	3000°K	C	Custom					TM8	8mm T-Mount Leg <sup>2</sup>
3720	223 lm/ft, 1.8 w/ft, 95 CRI	35	3500°K							CM8	8mm Corner Mount Leg <sup>2</sup>
3740	430 lm/ft, 3.5 w/ft, 95 CRI	40	4000°K							BU	Bushing <sup>2</sup>
3760	609 lm/ft, 5.2 w/ft, 95 CRI	45	4500°K								
3790	621 lm/ft, 6.9 w/ft, 98 CRI <sup>1</sup>	50	5000°K								
5133	315 lm/ft, 3.4 w/ft, 87 CRI <sup>1</sup>										
5163	548 lm/ft, 6.6 w/ft, 87 CRI <sup>1</sup>										

**Fixture Length**  
See Fixture Length and Wattage Table. Choose the correct Code number for the LED board and fixture length of your choice or specify Custom Length as follows: C (12.25") or C [311mm]

<sup>2</sup> Finish on Factory Installed Options will match specified finish; see Mounting Options page.

Standard HI CRI Pitchless Ultra HI CRI

<sup>1</sup>Not Available in 20K, 22K or 25K CCT

See Special Mounting Options for more information about specifying 1R fixtures in Display Case

Basic Fixture Accessories - See Mounting Options for more information

ELL - AC - 1R - PC	ELL - AC - 1R - LC	ELL - AC - 1R - SALC	ELL - AC - 1R - MRC
<b>Plastic Mounting Clip;</b> extrusion rotates into clip. Extrusion sits 1/16" (1.59mm) off mounting surface. See Mounting Options.	<b>Locking Adjustable Mounting Clip;</b> use one at each end of extrusion, alone or with Plastic Clips; 4-40 set screws lock extrusion at desired angle. Extrusion sits 1/16" (1.59mm) off mounting surface. See Mounting Options.	<b>Locking Adjustable Self-Adhesive Clip;</b> use alone or with Plastic Clips; attaches with VHB tape; 4-40 set screws lock extrusion at desired angle. Extrusion sits 1/16" (1.59mm) off mounting surface. See Mounting Options.	<b>Metal Mounting Clip;</b> Fixture extrusion rotates into clip. Countersunk screw-hole so fixture sits flush to mounting surface. Allows 60° rotation. Allow 1 per 12" (min. 2 per fixture); Polished Nickel Finish.

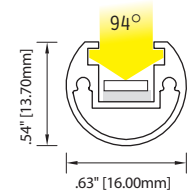
## 2RL LARGE ROUND EXTRUSION - LENSED

2RL: IP40 | Round extrusion for linear lighting applications. UL Listed dry/damp. Includes Nichia LEDs in choice of 11 LED Board options. See lumen outputs, CCTs, wattage and other variables on Linear Fundamentals.

Available in Silver, Black or Bronze Anodized, White Powder Coated, or Custom Finishes. Choice of Clear Acrylic lens (standard), 3 Opal diffusion lenses, or four focusing lenses L2 (18° - 31°), L3 (30° - 42°) or Lens 4 (78° - 82°). Photometrics vary based on CCT and lensing; see vltcorp.com for output conversion and other data specific to your fixture choices.



(Beam Angle based on 2RL fixture with Clear Acrylic lens)



### ELL-2RL -

LED		CCT		Finish		Lens Options <sup>2</sup>		Wire Exit		Listings & Options	
1720	260 lm/ft, 1.8 w/ft, 83 CRI	20	2000°K	AL	Silver Anodized	PG	Clear Acrylic	WE1	Default	UL	UL Listed
2730	397 lm/ft, 2.9 w/ft, 83 CRI	22	2200°K	BL	Black Anodized	L2	Lens 2 (18° - 31°)	C	Custom	CE	CE Marked (RoHS)
4740	528 lm/ft, 3.7 w/ft, 83 CRI	25	2500°K	BZ	Bronze Anodized	L3	Lens 3 (30° - 48°)	<b>Fixture Length</b> See Fixture Length and Wattage Table. Choose the correct Code number for the LED board and fixture length of your choice or specify Custom Length as follows: C (12.25") or C [311mm]		IM	Inside Mount End Caps <sup>3</sup>
5760	665 lm/ft, 4.9w/ft, 83CRI	27	2700°K	WH	White Powder Coat	L4	Lens 4 (78° - 82°)			EM8	8mm End Mount Leg <sup>3</sup>
6760	875 lm/ft, 6.5w/ft, 83 CRI	30	3000°K	C	Custom	OP1	Opal 1, Frosted	TM8	8mm T-Mount Leg <sup>3</sup>	CM8	8mm Corner Mount Leg <sup>3</sup>
3720	223 lm/ft, 1.8 w/ft, 95 CRI	35	3500°K			OP2	Opal 2, Medium	EM16	16mm End Mount Leg <sup>3</sup>	TM16	16mm T-Mount Leg <sup>3</sup>
3740	430 lm/ft, 3.5 w/ft, 95 CRI	40	4000°K			OP3	Opal 3, Heavy	CM16	16mm Corner Mount Leg <sup>3</sup>	BU	Bushing <sup>3</sup>
3760	609 lm/ft, 5.2 w/ft, 95 CRI	45	4500°K								
3790	621 lm/ft, 6.9 w/ft, 98 CRI <sup>1</sup>	50	5000°K								
5133	315 lm/ft, 3.4w/ft, 87 CRI <sup>1</sup>										
5163	548 lm/ft, 6.6w/ft, 87 CRI <sup>1</sup>										

<sup>2</sup> See Lensing Options for more information on L2, L3 & L4 optical lenses

<sup>3</sup> Finish on Factory Installed Options will match specified finish; see Mounting Options page.

■ Standard 
 ■ HI CRI 
 ■ Ultra HI CRI 
 ■ Pitchless

<sup>1</sup> Not Available in 20K, 22K or 25K CCT

See Special Mounting Options for more information about specifying 2RL fixtures in Display Case

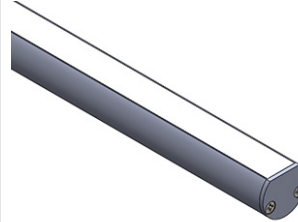
### Basic and Free Standing Fixture Accessories - See Mounting Options for more information

ELL - AC - 2RL - PC	ELL - AC - 2RL - LC	ELL - AC - 2RL -SALC	ELL - AC - 2RL - MRC
<b>Plastic Mounting Clip;</b> Fixture extrusion rotates into clip. Screws to mounting surface. Raises fixture 0.13" (3.18mm). Allows 30° rotation. Allow 1 per 12" (min. 2 per fixture); See Mounting Options.	<b>Locking Adjustable Mounting Clip;</b> Screws to mounting surface. Raises fixture 0.13" (3.18mm). Full rotation with locking screw. Finishes to match fixture. Allow 2 per fixture (48" max span). See Mounting Options.	<b>Locking Adjustable Mounting Clip with Self-Adhesive.</b> Raises fixture 0.13" (3.18mm). Full rotation with locking screw. Finishes to match fixture. Allow 2 per fixture (48" max span). See Mounting Options.	<b>Metal Mounting Clip;</b> Fixture extrusion rotates into clip. Countersunk screw-hole so fixture sits flush to mounting surface. Allows 60° rotation. Allow 1 per 12" (min. 2 per fixture); Polished Nickel Finish; See Mounting Options.

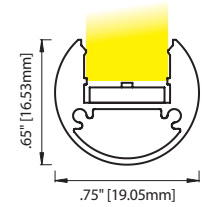
3RL LARGE ROUND EXTRUSION - LENSED

3RL: IP40 | Round extrusion for linear lighting applications. UL Listed dry/damp. Includes Nichia LEDs in choice of 21 LED Board options. See lumen outputs, CCTs, wattage and other variables on Linear Fundamentals.

Available in Silver, Black or Bronze Anodized, White Powder Coated, or Custom Finishes. Choice of Clear Acrylic lens (standard), 3 Opal diffusion lenses, or three focusing lenses L2 (18° - 31°), L3 (30° - 42°) or Lens 4 (78° - 82°). Photometrics vary based on CCT and lensing; see vltcorp.com for output conversion and other data specific to your fixture choices.



(Beam Angle based on 3RL fixture with Clear Acrylic lens)



ELL- 3RL -

	LED	CCT	Finish	Lens Options	Wire Exit	Listings & Options						
STANDARD PITCH	1720	260 lm/ft, 1.8 w/ft, 83+ CRI	20	2000°K	AL	Silver Anodized	PG	Clear Acrylic	WE1	Default	UL	UL Listed
	2730	397 lm/ft, 2.9 w/ft, 83+ CRI	22	2200°K	BL	Black Anodized	L2	Lens 2 (26° - 32°)	C	Custom	CE	CE Marked (RoHS)
	4740	528 lm/ft, 3.7 w/ft, 83+ CRI	25	2500°K	BZ	Bronze Anodized	L3	Lens 3 (50° - 51°)			EM8	8mm End Mount Leg <sup>3</sup>
	5760	665 lm/ft, 4.9 w/ft, 83+ CRI	27	2700°K	WH	White Powder Coat	L4	Lens 4 (89° - 92°)			TM8	8mm T-Mount Leg <sup>3</sup>
	6760	875 lm/ft, 6.5 w/ft, 83+ CRI	30	3000°K	C	Custom	OP1	Opal 1, Frosted				
	3720	223 lm/ft, 1.8 w/ft, 95+ CRI	35	3500°K			OP2	Opal 2, Medium				
	3740	430 lm/ft, 3.5 w/ft, 95+ CRI	40	4000°K			OP3	Opal 3, Heavy				
	3760	609 lm/ft, 5.2 w/ft, 95+ CRI	45	4500°K								
	3790	621 lm/ft, 6.9 w/ft, 98 CRI <sup>1</sup>	50	5000°K								
			20/30	2000°K/ 3000°K <sup>2</sup>								
PITCHLESS	5140	287 lm/ft, 2.2 w/ft, 83+ CRI	25/40	2500°K/ 4000°K <sup>2</sup>								
	5160	571 lm/ft, 4.3 w/ft, 83+ CRI	30/40	3000°K/ 4000°K <sup>2</sup>								
	5180	920 lm/ft, 6.9 w/ft, 83+ CRI	35/45	3500°K/ 4500°K <sup>2</sup>								
	3140	237 lm/ft, 2.2 w/ft, 95+ CRI										
	3160	469 lm/ft, 4.3 w/ft, 95+ CRI										
	3180	773 lm/ft, 6.9 w/ft, 95+ CRI										
	3150	202 lm/ft, 2.2 w/ft, 98 CRI <sup>1</sup>										
	3170	404 lm/ft, 3.9 w/ft, 98 CRI <sup>1</sup>										
	3190	710 lm/ft, 6.9 w/ft, 98 CRI <sup>1</sup>										
	7180	750 lm/ft, 6.9 w/ft, 83+/95+ CRI <sup>2</sup>										
5133	315 lm/ft, 3.4 w/ft, 87 CRI <sup>1</sup>											
5163	548 lm/ft, 6.6 w/ft, 87 CRI <sup>1</sup>											

**Fixture Length**  
See Fixture Length and Wattage Table. Choose the correct Code number for the LED board and fixture length of your choice or specify Custom Length as follows: C [12.25"] or C [311mm]

<sup>3</sup> Finish on Factory Installed Options will match specified finish; see Mounting Options page.

Standard    HI CRI    Pitchless/Standard  
Pitchless/Hi CRI    Pitchless/Dual Color  
Pitchless/Narrow Focus    Ultra HI CRI

<sup>1</sup> Not Available in 20K, 22K or 25K CCT  
<sup>2</sup> 7180 Boards Only: CRI Varies Based on CCT Combination

See Special Mounting Options for more information about specifying 3RL fixtures in Display Case

Basic and Free Standing Fixture Accessories - See Mounting Options for more information

ELL - AC - 3RL - PC	ELL - AC - 3RL - LC	ELL - AC - 3RL - SALC	ELL - AC - 3RL - MRC
<b>Plastic Mounting Clip;</b> Fixture extrusion rotates into clip. Screws to mounting surface. Raises fixture 0.13" (3.18mm). Allows 30° rotation. Allow 1 per 12" (min. 2 per fixture); See Mounting Options.	<b>Locking Adjustable Mounting Clip;</b> Screws to mounting surface. Raises fixture 0.13" (3.18mm). Full rotation with locking screw. Finishes to match fixture. Allow 2 per fixture (48" max span). See Mounting Options.	<b>Locking Adjustable Mounting Clip with Self-Adhesive.</b> Raises fixture 0.13" (3.18mm). Full rotation with locking screw. Finishes to match fixture. Allow 2 per fixture (48" max span). See Mounting Options.	<b>Metal Mounting Clip;</b> Fixture extrusion rotates into clip. Countersunk screw-hole so fixture sits flush to mounting surface. Allows 60° rotation. Allow 1 per 12" (min. 2 per fixture); Polished Nickel Finish; See Mounting Options.

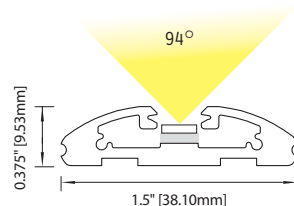




## 1EL DEMI-ELLIPSE EXTRUSION - LENSED

1EL: IP20 | Demi-Ellipse extrusion provides a low-profile fixture with recessed LED board to minimize side-view glare. Includes Nichia LEDs in choice of 11 LED Board options. See lumen outputs, CCTs, wattage and other variables on Linear Fundamentals.

Available in Silver, Black or Bronze Anodized, White Powder Coated, or Custom Finishes. Diffuser Film Lens. Photometrics vary based on CCT; see vltcorp.com for output conversion and other data specific to your fixture choices.



1EL - \_\_\_\_\_ - \_\_\_\_\_ - \_\_\_\_\_ - \_\_\_\_\_ - \_\_\_\_\_ - \_\_\_\_\_

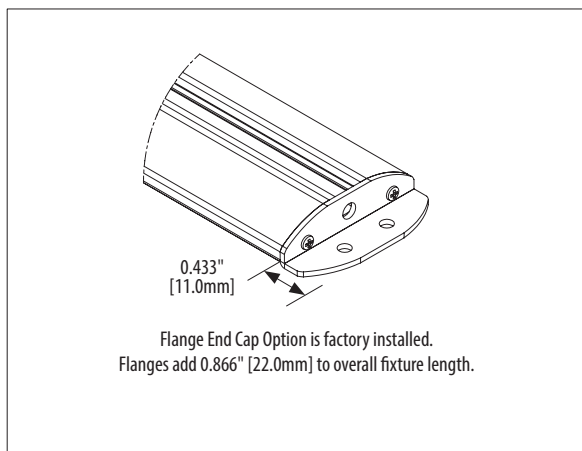
LED		CCT		Finish		Lens Options		Wire Exit		Listings & Options	
1720	260 lm/ft, 1.8 w/ft, 83 CRI	20	2000°K	AL	Silver Anodized	DF	Diffuser Film	WE1	Default	UL	UL Listed
2730	397 lm/ft, 2.9 w/ft, 83 CRI	22	2200°K	BL	Black Anodized			C	Custom	CE	CE Marked (RoHS)
4740	528 lm/ft, 3.7 w/ft, 83 CRI	25	2500°K	BZ	Bronze Anodized					FEC	Flange End Cap
5760	665 lm/ft, 4.9w/ft, 83CRI	27	2700°K	WH	White Powder Coat						
6760	875 lm/ft, 6.5w/ft, 83 CRI	30	3000°K	C	Custom						
3720	223 lm/ft, 1.8 w/ft, 95 CRI	35	3500°K								
3740	430 lm/ft, 3.5 w/ft, 95 CRI	40	4000°K								
3760	609 lm/ft, 5.2 w/ft, 95 CRI	45	4500°K								
3790	621 lm/ft, 6.9 w/ft, 98 CRI <sup>1</sup>	50	5000°K								
5133	315 lm/ft, 3.4 w/ft, 87 CRI <sup>1</sup>										
5163	548 lm/ft, 6.6 w/ft, 87 CRI <sup>1</sup>										

### Fixture Length

See Fixture Length and Wattage Table. Choose the correct Code number for the LED board and fixture length of your choice or specify Custom Length as follows: C (12.25") or C [311mm]

Standard HI CRI Ultra HI CRI Pitchless

<sup>1</sup> Not Available in 20K, 22K or 25K CCT



### Fixture Accessories

ELL - AC - 1EL - MC



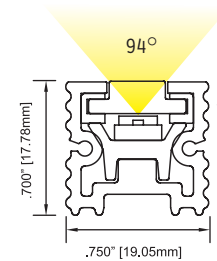
**Fixed Metal Mounting Clip;** Fixture snaps into clip. Countersunk screw-holes allow fixture to sit flush to mounting surface. Allow 1 clip per 12" (min. 2 per fixture). See Mounting Options.

5SSLW SQUARE EXTRUSION - EXTERIOR

UL Listed for Wet Locations | Square extrusion suitable for wet location linear lighting applications, both indoors and outdoors.<sup>1</sup> Includes Nichia LEDs in choice of 11 LED Board options. See lumen outputs, CCTs, wattage and other variables on Linear Fundamentals.

Available in Silver, Black, Bronze or White Powder Coated or Custom Finishes. Choice of Clear Acrylic lens (standard) or Opal diffusion lens. Photometrics vary based on CCT; see vltcorp.com for output conversion and other data specific to your fixture choices.

<sup>1</sup>A wet location is an interior or exterior location in which water or other liquids may drip, splash or flow on or against the electrical components of a lighting fixture.



(Beam Angle based on 5SSLW fixture with Clear Acrylic lens)

5SSLW -

LED		CCT		Finish		Lens Options		Wire Exit		Listings	
1720	260 lm/ft, 1.8 w/ft, 83 CRI	20	2000°K	AL	Silver Powder Coat	PG	Clear Acrylic	WE1R	4' Bare End	UL	UL Listed
2730	397 lm/ft, 2.9 w/ft, 83 CRI	22	2200°K	BL	Black Powder Coat	OP1	Opal 1, Frosted			CE	CE Listed (RoHS)
4740	528 lm/ft, 3.7 w/ft, 83 CRI	25	2500°K	BZ	Bronze Powder Coat						
5760	665 lm/ft, 4.9 w/ft, 83 CRI	27	2700°K	WH	White Powder Coat						
6760	875 lm/ft, 6.5 w/ft, 85 CRI	30	3000°K	C	Custom						
3720	223 lm/ft, 1.8 w/ft, 95 CRI	35	3500°K								
3740	430 lm/ft, 3.5 w/ft, 95 CRI	40	4000°K								
3760	609 lm/ft, 5.2 w/ft, 95 CRI	45	4500°K								
3790	621 lm/ft, 6.9 w/ft, 98 CRI <sup>1</sup>	50	5000°K								
5133	315 lm/ft, 3.4w/ft, 87 CRI <sup>1</sup>										
5163	548 lm/ft, 6.6w/ft, 87 CRI <sup>1</sup>										

**Fixture Length**  
See Fixture Length & Wattage Table. Choose the correct Code number for the LED board and fixture length of your choice. 72" Max Length.

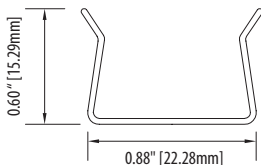
Standard HI CRI Ultra HI CRI Pitchless

<sup>1</sup> Not Available in 20K, 22K or 25K CCT

FIXED CLIP

SPECIFICATIONS

CAT. NO. ELL-AC-5SSLW-MC



Dimensions: 0.88" [22.28mm] x 0.60" [15.29mm]

Material: 301 Stainless Steel

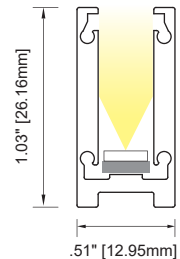
**Description:** Fixed Metal Clip for mounting 5SSLW square extrusion. Screws to mounting surface with screw, provided. Fixture extrusion snaps into clip. Allow 1 per 20" of extrusion (min. 2 per fixture).



## 4SL MEDIUM SQUARE TALL EXTRUSION - LENSED

4SL: IP40 | Square extrusion with 1" depth capable of full diffusion of LED diodes. Use decoratively for a slim (9/32") visible line of diffused light, or light up polished surfaces without reflected diodes. UL Listed dry/damp. Includes Nichia LEDs in choice of 11 LED Board options. See lumen outputs, CCTs, wattage and other variables on Linear Fundamentals.

Available in Silver or Black Anodized or Custom Finishes. Choice of 3 Opal diffusion lenses. Opal 2 (Medium) or Opal 3 (Heavy) required for full diffusion. Photometrics vary based on CCT and lensing; see vltcorp.com for conversion and other data specific to your fixture choices.



### ELL- 4SL -

LED		CCT		Finish		Lens Options		Wire Exit		Listings & Options	
1720	260 lm/ft, 1.8 w/ft, 83 CRI	20	2000°K	AL	Silver Anodized	OP1	Opal 1, Frosted	WE1	Default	UL	UL Listed
2730	397 lm/ft, 2.9 w/ft, 83 CRI	22	2200°K	BL	Black Anodized	OP2	Opal 2, Medium <sup>2</sup>	C	Custom	CE	CE Marked (RoHS)
4740	528 lm/ft, 3.7 w/ft, 83 CRI	25	2500°K	C	Custom	OP3	Opal 3, Heavy <sup>2</sup>			MAG	Magnetic Mount
5760	665 lm/ft, 4.9w/ft, 83CRI	27	2700°K								
6760	875 lm/ft, 6.5w/ft, 83 CRI	30	3000°K								
3720	223 lm/ft, 1.8 w/ft, 95 CRI	35	3500°K								
3740	430 lm/ft, 3.5 w/ft, 95 CRI	40	4000°K								
3760	609 lm/ft, 5.2 w/ft, 95 CRI	45	4500°K								
3790	621 lm/ft, 6.9 w/ft, 98 CRI <sup>1</sup>	50	5000°K								
5133	315 lm/ft, 3.4 w/ft, 87 CRI <sup>1</sup>										
5163	548 lm/ft, 6.6 w/ft, 87 CRI <sup>1</sup>										

<sup>2</sup> Will provide full diffusion

**Fixture Length**  
See Fixture Length and Wattage Table. Choose the correct Code number for the LED board and fixture length of your choice or specify Custom Length as follows: C (12.25") or C [311mm]

Standard HI CRI Ultra HI CRI Pitchless

<sup>1</sup> Not Available in 20K, 22K or 25K CCT

### Fixture Accessories - See Mounting Options For More Information on Rough-in Kit

ELL - AC - 4SL - MC	ELL - AC - 4SL - AMC	ELL - AC - S123 - AB	ELL - AC - 4SL - WCR - AL	Factory Installed; See Options Above
<b>Fixed Metal Mounting Clip</b> Fixture extrusion snaps into clip. Allow 1 per 12" (min. 2 per fixture). See Mounting Options.	<b>Adjustable Metal Mounting Clip</b> Offset screws allow flush mounting. Bends to desired angle. Allow 1 per 12" (min. 2 per fixture). See Mounting Options.	<b>Adjustable Metal Bracket</b> for use with Fixed Metal Mounting Clip (one bracket per clip). 30° adjustability. Raises fixture 3/8" (9.52mm). Bracket allows repeated angle adjustments and easier angle adjustments in hard-to-reach areas like ceiling coves. See Mounting Options.	<b>Wall / Ceiling Mounting Rough-in;</b> Specify length to match fixture length. 8-32 flat head screw allows height adjustment for flush installation. (Not walk-over or drive-over rated). See Mounting Options.	<b>Magnetic Mount</b> Factory-installed magnets hold fixture securely to ferrous surface or accessory <b>Steel Mounting Plates</b> ; 3 magnets per foot, factory installed. Magnets protrude 0.09" [2.3mm] above rear surface of extrusion.





## ELEGANCE LINEAR PUCK FUNDAMENTALS

All LEDs binned to within a 2 MacAdam ellipse CCT tolerance of  $\pm 60^\circ$   
 5263 LED Board available in **2700K, 3000K, 3500K, 4000K & 4500K.**

	<b>5263</b>
LUMEN OUTPUT	151 lm/in
FIXTURE WATTAGE	See Table at Right
CRI	87
CCT OPTIONS	2700K, 3000K, 3500K, 4000K & 4500K
APPLIED LED	157b
LED EFFICACY*	94 lm/w
FIXTURE EFFICACY* <small>not including driver losses</small>	TBD

Fixture Size	Total Wattage per Fixture
1	1.3w
2	2.6w
3	3.9w
4	5.2w

All photometrics based on 3500K CCT

LENSING	Lens options include clear or three levels of opal or focusing lenses in 18°, 30°, 78°
LENGTHS	1.5", 2.5", 3.4", 4.4" [38.1mm, 63.5mm, 86.36mm, 111.76mm]
FINISH	Silver, Black, Bronze, White & Custom Finishes on request
ELECTRICAL	<b>Driver Type:</b> Constant Voltage, Class 2 UL Listed as a system <b>Input Voltage:</b> 24vDC <b>Dimming:</b> ELV, 0-10V, DALI, DMX <b>Feed Wire:</b> 96" [2.44m] of 20 AWG Wire [1.02mm <sup>2</sup> ], Male Connector <b>Operating Ambient Temperature:</b> -22° to 104° F [-30° to 40° C] <b>Humidity:</b> 90% RH Non-Condensing <span style="float: right; border: 1px solid black; padding: 2px;">CV</span>
LIFE & WARRANTY	50,000 HR lifetime ( $T_a = -25^\circ\text{C}$ to $40^\circ\text{C}$ ; $T_c$ max $75^\circ\text{C}$ ); 5 year limited warranty
MOUNTING	Fixed, Magnetic or Adjustable Clips
LISTINGS & TESTS	eUL <sub>us</sub> (2108, 8750); CE RoHS Compliant (if specified); LM79, LM80; IP40; UL Listed Damp/Dry The EU's Restriction of Hazardous Substances Directive (RoHS) restricts the use of six hazardous substances* in electrical and electronic equipment (* Lead (Pb), Mercury, Cadmium, Hexavalent chromium, Polybrominated biphenyls and Polybrominated diphenyl ether (PBDE)). See list of countries that require RoHS compliance on page 20.

EssentialLEDs® Linear Puck segments feature our very bright 5263 LED board and were developed to provide extraordinary light output from a small, easily integrated linear fixture. Linear Pucks in Square, Round or Quarter Round segments come in four handy, pre-set lengths for use in small niches and displays. Linear Puck Square segments can be surface-mounted using fixed or adjustable clips, slipped into routed channels to sit flush with millwork, or mounted magnetically to suitable surfaces. Great for step lights, aisle lights or focused area shelf lighting. Linear Puck Round segments are easily rotated using any of our mounting clip options. Quarter Round segments self-mount using the extrusion flange.

Multiple Round, Square or Quarter Round Linear Puck segments can be daisy-chained together for easy wiring.

Fixtures are dimmable and available in five color temperatures; 87 CRI.

Visit the VLT website for application photos and most recent IES files.

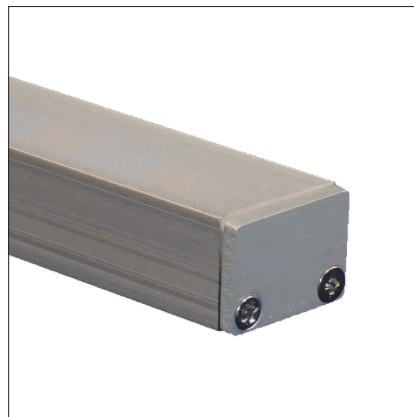
MADE IN USA 

CCT	2700K	3000K	3500K	4000K	4500K
LIGHT OUTPUT CONVERSION	0.88	1.0	1.0	1.08	1.08

VLT reserves the right to change specifications without notice. Please visit [www.vltcorp.com](http://www.vltcorp.com) for current cut sheets.



## CHOICE LINEAR



### VALUE-FOCUSED LINEAR LED FIXTURES

Offering a selection of narrow pitch CHOICE LEDs or standard pitch Nichia LEDs, EssentialLEDs CHOICE is a great new way to get your favorite linear profiles and the VLT quality and service you've come to expect at a price that fits all budgets.

## CHOICE LINEAR FUNDAMENTALS



Don't let the pricing of EssentialLEDs Choice Linear products fool you. You'll get the same great extrusions, lensing and accessories - not to mention VLT's amazing service - all at a fraction of the regular price.

EssentialLEDs® Choice Linear products provide bright, even linear lighting for a variety of interior applications, including architectural accents, coves, niches, millwork, task and display lighting. EssentialLEDs® Choice fixtures can be specified using any of the 7 LED board options shown on the next page, broken down into two categories:

1. Narrow Pitch Boards - Our best value LED boards also have nearly no spacing between LEDs, creating a near seamless line of light.
2. Standard Pitch Boards - These LED boards boast Nichia LEDs with 95 CRI and CCTs up to 5000°K.

The LED boards above can be used in any of 15 linear extrusions, with standard fixture sizes ranging from 1 inch up to approximately 8 feet (finished length options vary based on extrusion and LED board choices; see Fixture Length & Wattage Table for exact lengths).

EssentialLEDs® Linear products are fully dimmable and available in multiple standard and custom finishes; lensed extrusions can include diffusing lenses. Visit [www.vltdcorp.com](http://www.vltdcorp.com) for application photos and the most recent IES files.

LENSING	Lensed and unlensed options available; lens options include clear or up to three levels of Opal.
FINISH	All fixtures available in silver or black anodized finish; custom finishes upon request.
LENGTHS	See Length & Wattage Tables for all standard length options; Standard lengths up to 8ft.
ELECTRICAL	<p><b>Driver Type:</b> Constant Voltage, Class 2 UL Listed</p> <p><b>Input Voltage:</b> 24vDC <span style="float: right;"></span></p> <p><b>Dimming:</b> MLV, ELV, 0-10V, DALI, DMX</p> <p><b>Feed Wire:</b> 96" [2.44m] of 20 AWG Wire [1.02mm<sup>2</sup>], Male Connector</p> <p><b>Operating Ambient Temperature:</b> -22° to 104° F [-30° to 40° C]</p> <p><b>Humidity:</b> 90% RH Non-Condensing</p> <p><b>Electrostatic Sensitive Device:</b> VLT Recommends using additional surge protection with this unit (supplied by others). Surge damage is not covered by warranty </p>
LIFE & WARRANTY	50,000 HR lifetime (T <sub>a</sub> = -20°C to 60°C; T <sub>c</sub> max 67°C); 5 year limited warranty
MOUNTING	Mounting options differ according to extrusion; may include fixed and/or adjustable clips, mounting end caps, bushings, free-standing mount, recessed options; up to IP67
LISTINGS & TESTS	<p>cUL<sub>us</sub> (UL 2108 &amp; 8750); CE Marked; LM79, LM80; Title 24, JA8-2016<sup>1</sup>; Dry/Damp. (IP Ratings for reference purposes only)</p> <p>1R and 1S NOT UL Listed for closet space; All extrusions UL Listed for closet space when using 1435 board.</p> <p>The EU's Restriction of Hazardous Substances Directive (RoHS) restricts the use of six hazardous substances* in electrical and electronic equipment (* Lead (Pb), Mercury, Cadmium, Hexavalent chromium, Polybrominated biphenyls and Polybrominated diphenyl ether (PBDE)).</p> <p><sup>1</sup> Please consult factory for JA8-2016 compliant driver selection.</p>

VLT reserves the right to change specifications without notice. Please visit [www.vltdcorp.com](http://www.vltdcorp.com) for current cut sheets. **MADE IN USA** 

## NARROW PITCH LED BOARDS

LED BOARD	1435	2435	3435	4435
LUMEN OUTPUT <sup>1</sup>	288 lm/ft [945 lm/m]	384 lm/ft [1260 lm/m]	478 lm/ft [1568 lm/m]	610 lm/ft [2000 lm/m]
POWER CONSUMPTION	2.74 w/ft [9 w/m]	3.66 w/ft [12 w/m]	5.52 w/ft [18 w/m]	5.79 w/ft [19 w/m]
COUPON LENGTH	0.98" [25mm]	0.98" [25mm]	0.98" [25mm]	0.98" [25mm]
LED PITCH	3.57mm	3.57mm	3.57mm	3.57mm
CRI	90+	90+	90+	90+
CCT OPTIONS	2300K, 2700K, 3000K, 3500K, 4000K			
BINNING	3 Step MacAdam Ellipse			
LED EFFICACY <sup>1</sup>	105 lm/w	105 lm/w	105 lm/w	105 lm/w

Pitch is the term used to describe the spacing between LEDs on a circuit board. Our Narrow Pitch LED Boards have LEDs spaced very closely together, resulting in almost no "dot" pattern when diffused by our Opal lenses - even in our smallest extrusions.

Our Narrow Pitch LED Boards come in three lumen packages with all LEDs binned to 3 MacAdam Ellipses. These boards have a CRI of 90 or higher to meet California's Title 24 requirements.

## STANDARD PITCH LED BOARDS

LED BOARD	1320	2320	4320
LUMEN OUTPUT <sup>1</sup>	222 lm/ft [728 lm/m]	335 lm/ft [1098 lm/m]	590 lm/ft [1935 lm/m]
POWER CONSUMPTION	2.0 w/ft [6.6 w/m]	2.8 w/ft [9.2 w/m]	5.9 w/ft [19.4 w/m]
COUPON LENGTH	3.28" [83.3mm]	3.28" [83.3mm]	3.28" [83.3mm]
LED PITCH	11.9mm	11.9mm	11.9mm
CRI	95+	95+	95+
CCT OPTIONS	2700K, 3000K, 3500K, 4000K, 4500K		
APPLIED LED	Nichia 3030 SMD	Nichia 3030 SMD	Nichia 3030 SMD
BINNING	2 Step MacAdam Ellipse		
LED EFFICACY <sup>1</sup>	111 lm/w	119 lm/w	100 lm/w

This series of LED Boards offers Nichia LEDs with an amazing 95 CRI (or higher). Lumen output ranges from 222 lm/ft to 590 lm/ft to satisfy the needs of many different interior lighting applications.

Our Standard Pitch LED Boards are all binned to 2 MacAdam Ellipses, matching our premium EssentialLEDs Linear offerings at a fraction of the price.

<sup>1</sup> Based on 3500K CCT



## FIXTURE LENGTH & WATTAGE TABLE

Use Code numbers below to specify fixture lengths for ML1, 1S, 4SL, 7SL, 8SL, 8CL, 8FL, 9SL, 1R, 2RL, 3RL, 1EL, 1QL, 2QL and 5SLW extrusions.

A finished fixture length that differs from these lengths would be considered a Custom Length. Custom length fixtures have a finished length (including end caps) exactly as specified; an LED board that is the next size down is centered in the custom length fixture. Narrow Pitch LED Boards can be cut into increments as small as 25mm [1"]. Standard Pitch LED Boards are cuttable in increments of 83.3mm [3.28"]. Please contact factory for more information.

LED fixtures have a generous field angle, so a fixture does not need to extend the full length of a cabinet, shelf or display case for the area to be fully lit. Custom fixtures are most often used where the fixture is visible and an exact length is desired for aesthetic reasons. (Field Angle may be affected by lensing choice).

Narrow Pitch							Standard Pitch				
CODE	ML1, 1S, 4SL, 1R, 2RL, 1EL, 1QL, 5SLW <sup>2</sup>	7SL, 8CL, 8FL <sup>3</sup> , 8SL, 9SL, 3RL & 2QL	1435	2435	3435	4435 <sup>1</sup>	CODE	8CL, 8FL <sup>3</sup> , 8SL, 9SL, 3RL & 2QL	1320	2320	4320
4	4.72" [120mm]	4.29" [109mm]	0.90w	1.23w	1.84w	1.93w	4	3.63" [92mm]	0.55w	0.76w	1.61w
8	8.66" [220mm]	8.23" [209mm]	1.80w	2.47w	3.68w	3.87w	7	6.91" [176mm]	1.09w	1.53w	3.22w
12	12.60" [320mm]	12.17" [309mm]	2.70w	3.70w	5.52w	5.80w	10	10.19" [259mm]	1.64w	2.29w	4.83w
16	16.54" [420mm]	16.10" [409mm]	3.60w	4.93w	7.36w	7.73w	14	13.47" [342mm]	2.18w	3.05w	6.44w
20	20.47" [520mm]	20.04" [509mm]	4.50w	6.17w	9.20w	9.67w	17	16.75" [426mm]	2.73w	3.82w	8.05w
24	24.41" [620mm]	23.98" [609mm]	5.40w	7.40w	11.04w	11.60w	20	20.03" [509mm]	3.27w	4.58w	9.65w
28	28.35" [720mm]	27.91" [709mm]	6.30w	8.63w	12.88w	13.53w	23	23.31" [592mm]	3.82w	5.35w	11.26w
32	32.28" [820mm]	31.85" [809mm]	7.20w	9.87w	14.72w	15.47w	27	26.59" [675mm]	4.36w	6.11w	12.87w
36	36.22" [920mm]	35.79" [909mm]	8.10w	11.10w	16.56w	17.40w	30	29.87" [759mm]	4.91w	6.87w	14.48w
40	40.16" [1020mm]	39.72" [1009mm]	9.00w	12.33w	18.40w	19.33w	33	33.15" [842mm]	5.45w	7.64w	16.09w
44	44.09" [1120mm]	43.66" [1109mm]	9.90w	13.57w	20.24w	21.27w	36	36.43" [925mm]	6.00w	8.40w	17.70w
48	48.03" [1220mm]	47.60" [1209mm]	10.80w	14.80w	22.08w	23.20w	40	39.71" [1009mm]	6.55w	9.16w	19.31w
52	51.97" [1320mm]	51.54" [1309mm]	11.70w	16.03w	23.92w	25.13w	43	42.99" [1092mm]	7.09w	9.93w	20.92w
56	55.91" [1420mm]	55.47" [1409mm]	12.60w	17.26w	25.76w	27.06w	46	46.27" [1175mm]	7.64w	10.69w	22.53w
60	59.84" [1520mm]	59.41" [1509mm]	13.50w	18.50w	27.60w	29.00w	50	49.55" [1259mm]	8.18w	11.45w	24.14w
64	63.78" [1620mm]	63.35" [1609mm]	14.40w	19.73w	29.44w	30.93w	53	52.83" [1342mm]	8.73w	12.22w	25.74w
68	67.72" [1720mm]	67.28" [1709mm]	15.30w	20.96w	31.28w	32.86w	56	56.11" [1425mm]	9.27w	12.98w	27.35w
72	71.65" [1820mm]	71.22" [1809mm]	16.20w	22.20w	33.12w	34.80w	59	59.39" [1508mm]	9.82w	13.75w	28.96w
76	75.59" [1920mm]	75.16" [1909mm]	17.10w	23.43w	34.96w	36.73w	63	62.67" [1592mm]	10.36w	14.51w	30.57w
80	79.53" [2020mm]	79.09" [2009mm]	18.00w	24.66w	36.80w	38.66w	66	65.94" [1675mm]	10.91w	15.27w	32.18w
84	83.46" [2120mm]	83.03" [2109mm]	18.90w	25.90w	38.64w	40.60w	70	69.22" [1758mm]	11.45w	16.04w	33.79w
88	87.40" [2220mm]	86.97" [2209mm]	19.80w	27.13w	40.48w	42.53w	73	72.50" [1842mm]	12.00w	16.80w	35.40w
92	91.34" [2320mm]	90.91" [2309mm]	20.70w	28.36w	42.32w	44.46w	76	75.78" [1925mm]	12.55w	17.56w	37.01w
96	95.28" [2420mm]	94.84" [2409mm]	21.60w	29.60w	44.16w	46.40w	79	79.06" [2008mm]	13.09w	18.33w	38.62w
							82	82.34" [2092mm]	13.64w	19.09w	40.23w
							86	85.62" [2175mm]	14.18w	19.85w	41.83w
							89	88.90" [2258mm]	14.73w	20.62w	43.44w
							92	92.18" [2341mm]	15.27w	21.38w	45.05w
							95	95.46" [2425mm]	15.82w	22.15w	46.66w

<sup>1</sup> Available Only in 8CL, 8FL, 8SL, 9SL, 3RL & 2QL

<sup>2</sup> 5SLW adds 0.63" [16mm] to length. 5SLW only available up to 72.29" [1836mm]

<sup>3</sup> 8FL adds 0.22" [5.6mm] to length

## CHOICE LINEAR FIXTURE EXTRUSIONS

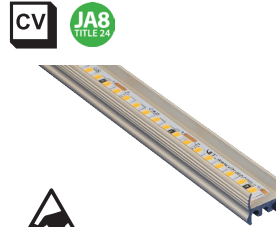
<p><b>ML1 - Mini Designer</b> (0.042 lb/ft [0.0625 kg/m])</p>	<p><b>1S - Small Square</b> (0.0534 lb/ft [0.0795 kg/m])</p>	<p><b>7SL - Small Square/Lensed</b> (0.0675 lb/ft [0.1003 kg/m])</p>	<p><b>5SLW - Square Extrusion</b> (0.3300 lb [0.4911 kg/m] per foot)</p>
<p><b>8SL - Medium Square/Lensed</b> (0.0925 lb/ft [0.1376 kg/m])</p>	<p><b>8CL - Medium Square/Lensed</b> (0.0600 lb/ft [0.0893 kg/m])</p>	<p><b>8FL - Medium Flanged/Lensed</b> (0.0925 lb/ft [0.1376 kg/m])</p>	<p><b>9SL - Large Square/Lensed</b> (0.2750 lb/ft [0.4091 kg/m])</p>
<p><b>1R - Small Round</b> (0.1026 lb/ft [0.1527 kg/m])</p>	<p><b>2RL - Large Round/Lensed</b> (0.1623 lb/ft [0.2415 kg/m])</p>	<p><b>3RL - Large Round/Lensed</b> (0.1700 lb/ft [0.2530 kg/m])</p>	<p><b>4SL - Medium Square Tall/Lensed</b> (0.2955 lb/ft [0.4398 kg/m])</p>
<p><b>1EL - Demi Ellipse/Lensed</b> (0.3300 lb/ft [0.4911 kg/m])</p>	<p><b>1QL - Quarter Round/Lensed</b> (0.1899 lb/ft [0.2826 kg/m])</p>	<p><b>2QL - Quarter Round/Lensed</b> (0.2300 lb/ft [0.3423 kg/m])</p>	



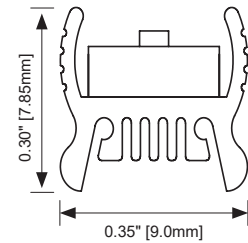
## New! ML1 CHOICE MINI DESIGNER EXTRUSION - NO LENS

ML1 Choice:IP20 | Rounded extrusion for linear lighting applications. Includes selection of 3 LED Boards with EssentialLEDs Choice LEDs on a Narrow Pitch. See lumen outputs, CCTs, wattage and other variables on Choice Linear Fundamentals.

Available in Silver or Black Finishes. Photometrics vary based on CCT; see vltcorp.com for output conversion and other data specific to your fixture choices.



OBSERVE PRECAUTIONS FOR HANDLING ELECTROSTATIC SENSITIVE DEVICES



AVAILABLE IN LENGTHS UP TO 95.28" [2420MM]

ELC- ML1 -

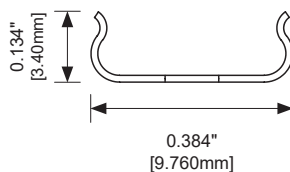
LED		CCT		Finish		Lens Options		Wire Exit		Listings & Options	
1435	288 lm/ft, 2.7 w/ft, 90+ CRI	23	2300K	AL	Silver Anodized	NL	No Lens	WE1	Default	UL	UL Listed
2435	384 lm/ft, 3.7 w/ft, 90+ CRI	27	2700K	BL	Black Anodized					CE	CE Listed (RoHS)
3435	478 lm/ft, 5.5 w/ft, 90+ CRI	30	3000°K							MAG	Magnetic Mount
		35	3500°K								
		40	4000°K								

Narrow Pitch Choice LEDs

**Fixture Length**  
See Fixture Length and Wattage Table. Choose the correct Code number for the LED board and fixture length of your choice or specify Custom Length as follows: C (12.25") C (311mm)

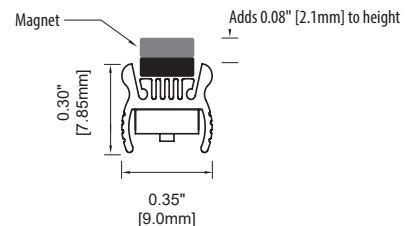
### Fixture Accessories

#### ELL - AC - MLR - MC



**Description:** Fixed Metal Clip for mounting ML1 extrusion. Screws to mounting surface with screw, provided. Fixture snaps into clip. Allow 1 per 12" of extrusion (min. 2 per fixture).

#### Factory Installed; See Options Above



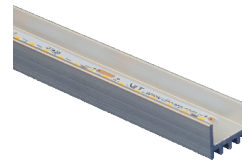
**Description:** Magnetic Mount for ML1 extrusion. Small, strong magnets recess into rear side of fixture extrusions for magnetic mounting of fixture on suitable surface. Factory installed. Adds 0.08" [2.1mm] to fixture height.

**New!** 1S CHOICE SMALL SQUARE EXTRUSION - OPTIONAL LENS

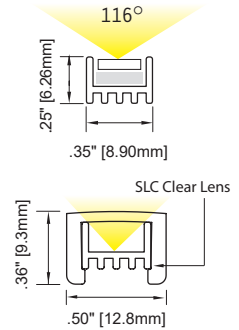
1S Choice: IP20 | Small square extrusion for linear lighting applications. Includes selection of 3 LED Boards with EssentialLEDs Choice LEDs on a Narrow Pitch. See lumen outputs, CCTs, wattage and other variables on Choice Linear Fundamentals.

Available in Silver or Black Finishes. Photometrics vary based on CCT; see vltcorp.com for output conversion and other data specific to your fixture choices.

AVAILABLE IN LENGTHS UP TO 95.28" [2420MM]



OBSERVE PRECAUTIONS FOR HANDLING ELECTROSTATIC SENSITIVE DEVICES



ELC- 1S -

LED

1435	288 lm/ft, 2.7 w/ft, 90+ CRI
2435	384 lm/ft, 3.7 w/ft, 90+ CRI
3435	478 lm/ft, 5.5 w/ft, 90+ CRI

  Narrow Pitch Choice LEDs

Finish

AL	Silver Anodized
BL	Black Anodized

Wire Exit

WE1	Default
C	Custom

Listings

UL	UL Listed	
CE	CE Marked (RoHS)	

CCT

23	2300°K
27	2700°K
30	3000°K
35	3500°K
40	4000°K

Lens Options

NL	No Lens
SLC	Clear Lens <sup>1</sup>

<sup>1</sup>With Clear Lens, use ELL-AC-2SL-MC Fixed Metal Mounting Clip

Fixture Length

See Fixture Length and Wattage Table. Choose the correct Code number for the LED board and fixture length of your choice or specify Custom Length as follows: C (12.25") or C [311mm]

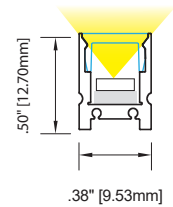
Fixture Accessories

ELL - AC - 1S - MC	ELL - AC - 1S - AMC	ELL - AC - S123 - AB	ELL - AC - 2SL - MC
<b>Fixed Metal Mounting Clip.</b> Fixture with No Lens snaps into clip. Allow 1 per 12" (min. 2 per fixture). See Mounting Options.	<b>Adjustable Metal Mounting Clip.</b> Offset screws allow flush mounting. Bends to desired angle. Allow 1 per 12" (min. 2 per fixture). See Mounting Options.	<b>Adjustable Metal Bracket.</b> for use with Fixed Metal Mounting Clip (one bracket per clip). 30° adjustability. Raises fixture 3/8" (9.52mm). Bracket allows repeated angle adjustments, and easier angle adjustments in hard-to-reach areas like ceiling covers. See Mounting Options.	<b>Fixed Metal Mounting Clip.</b> Fixture with SLC Lens snaps into clip. Allow 1 per 12" (min. 2 per fixture). See Mounting Options.

### New! 7SL CHOICE SMALL SQUARE EXTRUSION - EDGE TO EDGE

7SL Choice: IP54 | Small square extrusion for linear lighting applications. Slim extrusion wall (0.15") and edge-to-edge snap-in lensing for extra lumen output. UL Listed dry/damp. Includes selection of 3 LED Boards with EssentialLEDs Choice LEDs on a Narrow Pitch. See lumen outputs, CCTs, wattage and other variables on Choice Linear Fundamentals.

Available in Silver or Black Finishes. Opal 2 (Medium) or Opal 3 (Heavy) required for full diffusion. Photometrics vary based on CCT and lensing; see vltcorp.com for conversion and other data specific to your fixture choices.



AVAILABLE IN LENGTHS UP TO 94.84" [2409MM]

### ELC- 7SL -

LED		Finish		Wire Exit		Listings & Options	
1435	288 lm/ft, 2.7 w/ft, 90+ CRI	AL	Silver Anodized	WE1	Default	UL	UL Listed
2435	384 lm/ft, 3.7 w/ft, 90+ CRI	BL	Black Anodized	C	Custom	CE	CE Marked (RoHS)
3435	478 lm/ft, 5.5 w/ft, 90+ CRI					MAG	Magnetic Mount

CCT		Lens Options		Fixture Length	
23	2300°K	PG	Clear Acrylic	See Fixture Length and Wattage Table. Choose the correct Code number for the LED board and fixture length of your choice or specify Custom Length as follows: C (12.25") or C [311mm]	
27	2700°K	OP1	Opal 1, Frosted		
30	3000°K	OP2	Opal 2, Medium <sup>1</sup>		
35	3500°K	OP3	Opal 3, Heavy <sup>1,2</sup>		
40	4000°K				

<sup>1</sup> Will provide full diffusion  
<sup>2</sup> Not Title 24 JA8-2016 compliant

Narrow Pitch Choice LEDs

### Fixture Accessories

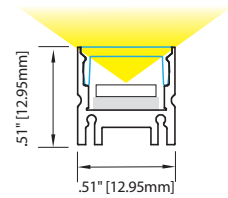
ELL - AC - 7SL - MC	ELL - AC - 7SL - AMC	ELL - AC - S123 - AB	Factory Installed; See Options Above
<b>Fixed Metal Mounting Clip.</b> Fixture extrusion snaps into clip. Allow 1 per 12" (min. 2 per fixture). See Mounting Options.	<b>Adjustable Metal Mounting Clip.</b> Offset screws allow flush mounting. Bends to desired angle. Allow 1 per 12" (min. 2 per fixture). See Mounting Options.	<b>Adjustable Metal Bracket</b> for use with Fixed Metal Mounting Clip (one bracket per clip). 30° adjustability. Raises fixture 3/8" (9.52mm). Bracket allows repeated angle adjustments, and easier angle adjustments in hard-to-reach areas like ceiling coves. See Mounting Options.	<b>Magnetic Mount</b> Small, strong, factory installed magnets recess into rear side of fixture extrusions for mounting of fixture onto suitable ferrous surface or accessory Steel Mounting Plates; 3 magnets per foot. Magnets protrude 0.08" [2.1mm] above rear surface of extrusion.



**New!** 8SL CHOICE MEDIUM SQUARE EXTRUSION - EDGE TO EDGE LENS

8SL Choice: IP54 | Medium square extrusion for linear lighting applications. Slim extrusion wall (0.15") and edge-to-edge snap-in lensing for extra lumen output. UL Listed dry/damp. Includes selection of 7 LED Boards: 3 with Nichia LEDs on a Standard Pitch; 4 with EssentialLEDs Choice LEDs on a Narrow Pitch. See lumen outputs, CCTs, wattage and other variables on Choice Linear Fundamentals.

Available in Silver or Black Finishes. Photometrics vary based on CCT and lensing; see vltcorp.com for conversion and other data specific to your fixture choices.



AVAILABLE IN LENGTHS UP TO 95.46" [2425MM]

ELC- 8SL -

LED		Finish		Wire Exit		Listings & Options	
1435	288 lm/ft, 2.7 w/ft, 90+ CRI <sup>2</sup>	AL	Silver Anodized	WE1	Default	UL	UL Listed
2435	384 lm/ft, 3.7 w/ft, 90+ CRI <sup>2</sup>	BL	Black Anodized	C	Custom	CE	CE Marked (RoHS)
3435	478 lm/ft, 5.5 w/ft, 90+ CRI <sup>2</sup>					MAG	Magnetic Mount
4435	610 lm/ft, 5.8 w/ft, 90+ CRI <sup>2</sup>						
1320	222 lm/ft, 2.0 w/ft, 95+ CRI <sup>1</sup>						
2320	335 lm/ft, 2.8 w/ft, 95+ CRI <sup>1</sup>						
4320	590 lm/ft, 5.9 w/ft, 95+ CRI <sup>1</sup>						

CCT		Lens Options		Fixture Length	
23	2300°K	PG	Clear Acrylic	See Fixture Length and Wattage Table. Choose the correct Code number for the LED board and fixture length of your choice or specify Custom Length as follows: C (12.25") or C [311mm]	
27	2700°K	OP1	Opal 1, Frosted		
30	3000°K	OP2	Opal 2, Medium <sup>3</sup>		
35	3500°K	OP3	Opal 3, Heavy <sup>3, 4</sup>		
40	4000°K				
45	4500°K				

<sup>1</sup> Not Available in 23K CCT  
<sup>2</sup> Not Available in 45K CCT  
<sup>3</sup> Will provide full diffusion  
<sup>4</sup> Not Title 24 JA8-2016

■ Narrow Pitch Choice LEDs  
■ Standard Pitch Nichia LEDs

Fixture Accessories

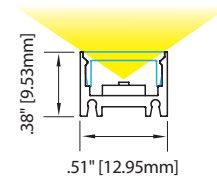
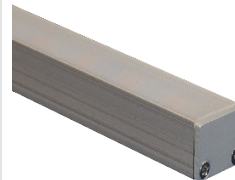
ELL - AC - 8SL - MC	ELL - AC - 8SL - AMC	ELL - AC - S123 - AB	Factory Installed; See Options Above
<b>Fixed Metal Mounting Clip.</b> Fixture extrusion snaps into clip. Allow 1 per 12" (min. 2 per fixture). See Mounting Options.	<b>Adjustable Metal Mounting Clip</b> Offset screws allow flush mounting. Bends to desired angle. Allow 1 per 12" (min. 2 per fixture). See Mounting Options.	<b>Adjustable Metal Bracket</b> for use with Fixed Metal Mounting Clip (one bracket per clip). 30° adjustability. Raises fixture 3/8" (9.52mm). Bracket allows repeated angle adjustments, and easier angle adjustments in hard-to-reach areas like ceiling covers. See Mounting Options.	<b>Magnetic Mount</b> Small, strong, factory installed magnets recess into rear side of fixture extrusions for mounting of fixture onto suitable ferrous surface or accessory Steel Mounting Plates. 3 magnets per foot. Magnets protrude 0.09" [2.3mm] above rear surface of extrusion.

## New! 8CL CHOICE MEDIUM SQUARE COMPACT EXTRUSION - EDGE TO EDGE LENS

8CL Choice: IP54 | Compact medium square extrusion for linear lighting applications. Slim extrusion wall (0.15") and edge-to-edge snap-in lensing for extra lumen output. UL Listed dry/damp. Includes selection of 7 LED Boards: 3 with Nichia LEDs on a Standard Pitch; 4 with EssentialLEDs Choice LEDs on a Narrow Pitch. See lumen outputs, CCTs, wattage and other variables on Choice Linear Fundamentals.

Available in Silver or Black Finishes. Opal 2 (Medium) or Opal 3 (Heavy) required for full diffusion. Photometrics vary based on CCT and lensing; see vltcorp.com for conversion and other data specific to your fixture choices.

AVAILABLE IN LENGTHS UP TO 95.46" [2425MM]



ELC- 8CL - \_\_\_\_\_ - \_\_\_\_\_ - \_\_\_\_\_ - \_\_\_\_\_ - \_\_\_\_\_ - \_\_\_\_\_ - \_\_\_\_\_ - \_\_\_\_\_

### LED

1435	288 lm/ft, 2.7 w/ft, 90+ CRI <sup>2</sup>
2435	384 lm/ft, 3.7 w/ft, 90+ CRI <sup>2</sup>
3435	478 lm/ft, 5.5 w/ft, 90+ CRI <sup>2</sup>
4435	610 lm/ft, 5.8 w/ft, 90+ CRI <sup>2</sup>
1320	222 lm/ft, 2.0 w/ft, 95+ CRI <sup>1</sup>
2320	335 lm/ft, 2.8 w/ft, 95+ CRI <sup>1</sup>
4320	590 lm/ft, 5.9 w/ft, 95+ CRI <sup>1</sup>

- Narrow Pitch Choice LEDs
- Standard Pitch Nichia LEDs

<sup>1</sup> Not Available in 23K CCT

<sup>2</sup> Not Available in 45K CCT

### Finish

AL	Silver Anodized
BL	Black Anodized

### Wire Exit

WE1	Default
C	Custom

### Listings & Options

UL	UL Listed	
CE	CE Marked (RoHS)	
MAG	Magnetic Mount	

### CCT

23	2300°K
27	2700°K
30	3000°K
35	3500°K
40	4000°K
45	4500°K

### Lens Options

PG	Clear Acrylic
OP1	Opal 1, Frosted
OP2	Opal 2, Medium <sup>3</sup>
OP3	Opal 3, Heavy <sup>3, 4</sup>

<sup>3</sup> Will provide full diffusion

<sup>4</sup> Not Title 24 JA8-2016 compliant

### Fixture Length

See Fixture Length and Wattage Table. Choose the correct Code number for the LED board and fixture length of your choice or specify Custom Length as follows: C (12.25") or C [311mm]

### Fixture Accessories

ELL - AC - 2SL - MC



**Fixed Metal Mounting Clip.** Fixture extrusion snaps into clip. Allow 1 per 12" (min. 2 per fixture). See Mounting Options.

ELL - AC - 2SL - AMC



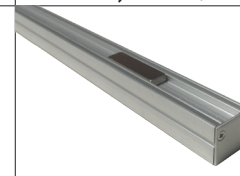
**Adjustable Metal Mounting Clip** Offset screws allow flush mounting. Bends to desired angle. Allow 1 per 12" (min. 2 per fixture). See Mounting Options.

ELL - AC - S123 - AB



**Adjustable Metal Bracket** for use with Fixed Metal Mounting Clip (one bracket per clip). 30° adjustability. Raises fixture 3/8" (9.52mm). Bracket allows repeated angle adjustments, and easier angle adjustments in hard-to-reach areas like ceiling coves. See Mounting Options.

Factory Installed; See Options Above



**Magnetic Mount** Small, strong, factory installed magnets recess into rear side of fixture extrusions for mounting of fixture onto suitable ferrous surface or accessory Steel Mounting Plates (see Mounting Options). 3 magnets per foot. Magnets protrude 0.09" [2.3mm] above rear surface of extrusion.



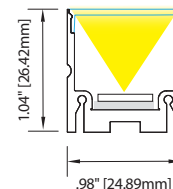
## New! 9SL CHOICE LARGE SQUARE EXTRUSION - EDGE TO EDGE LENS

9SL Choice: IP54 | Large square extrusion for linear lighting applications. Slim extrusion wall (0.15") and edge-to-edge snap-in lensing for extra lumen output. UL Listed dry/damp. Includes selection of 8 LED Boards: 3 with Nichia LEDs on a Standard Pitch; 4 with EssentialLEDs Choice LEDs on a Narrow Pitch and 1 Dual Row configuration for maximum illumination. See lumen outputs, CCTs, wattage and other variables on Choice Linear Fundamentals.

For maximum lumen output, choose Dual Row 3435D LED board.

Available in Silver or Black Finishes. Photometrics vary based on CCT and lensing; see vltcorp.com for conversion and other data specific to your fixture choices.

AVAILABLE IN LENGTHS UP TO 95.46" [2425MM]



ELC-9SL -

LED		Finish		Wire Exit		Listings & Options	
1435	288 lm/ft, 2.7 w/ft, 90+ CRI <sup>2</sup>	AL	Silver Anodized	WE1	Default	UL	UL Listed
2435	384 lm/ft, 3.7 w/ft, 90+ CRI <sup>2</sup>	BL	Black Anodized	C	Custom	CE	CE Marked (RoHS)
3435	478 lm/ft, 5.5 w/ft, 90+ CRI <sup>2</sup>					MAG	Magnetic Mount
4435	610 lm/ft, 5.8 w/ft, 90+ CRI <sup>2</sup>						
3435D	956 lm/ft, 11.0 w/ft, 90+ CRI <sup>2</sup>						
1320	222 lm/ft, 2.0 w/ft, 95+ CRI <sup>1</sup>						
2320	335 lm/ft, 2.8 w/ft, 95+ CRI <sup>1</sup>						
4320	590 lm/ft, 5.9 w/ft, 95+ CRI <sup>1</sup>						
		CCT		Lens Options		Fixture Length	
		23	2300°K	PG	Clear Acrylic	See Fixture Length and Wattage Table. Choose the correct Code number for the LED board and fixture length of your choice or specify Custom Length as follows: C (12.25") or C [311mm]	
		27	2700°K	OP1	Opal 1, Frosted		
		30	3000°K	OP2	Opal 2, Medium <sup>3</sup>		
		35	3500°K	OP3	Opal 3, Heavy <sup>3, 4</sup>		
		40	4000°K				
		45	4500°K				

- Narrow Pitch Choice LEDs
- Standard Pitch Nichia LEDs
- Dual Rows

<sup>1</sup> Not Available in 23K CCT

<sup>2</sup> Not Available in 45K CCT

<sup>3</sup> Will provide full diffusion  
<sup>4</sup> Not Title 24 JA8-2016 compliant

### Fixture Accessories

ELL - AC - 9SL - MC	ELL - AC - 9SL - AMC	ELL - AC - S123 - AB	ELL - AC - 9SL - WCR - AL	Factory Installed; See Options Above
<b>Fixed Metal Mounting Clip.</b> Fixture extrusion snaps into clip. Allow 1 per 12" (min. 2 per fixture). See Mounting Options.	<b>Adjustable Metal Mounting Clip.</b> Offset screws allow flush mounting. Bends to desired angle. Allow 1 per 12" (min. 2 per fixture). See Mounting Options.	<b>Adjustable Metal Bracket</b> for use with Fixed Metal Mounting Clip (one bracket per clip). 30° adjustability. Raises fixture 3/8" (9.52mm). Bracket allows repeated angle adjustments, and easier angle adjustments in hard-to-reach areas like ceiling coves. See Mounting Options.	<b>Wall / Ceiling Mounting Rough-in;</b> Specify length to match fixture length. 8-32 flat head screw allows height adjustment for flush installation. (Not walk-over or drive-over rated). See Special Mounting Options.	<b>Magnetic Mount</b> Small, strong, factory installed magnets recess into rear side of fixture extrusions for mounting of fixture onto suitable ferrous surface or accessory Steel Mounting Plates (see Mounting Options); 3 magnets per foot.

**New!** 1QL CHOICE QUARTER ROUND EXTRUSION - LENSED

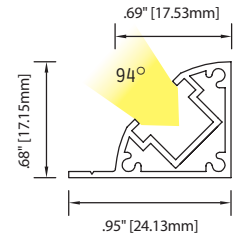
1QL Choice: IP40 | Quarter Round extrusion fits snugly into corners for bright, even linear lighting. UL Listed dry/damp. Includes selection of 3 LED Boards with EssentialLEDs Choice LEDs on a Narrow Pitch. See lumen outputs, CCTs, wattage and other variables on Choice Linear Fundamentals.

Available in Silver or Black Finishes. Choice of Clear Acrylic lens (standard), or 3 Opal diffusion lenses. Photometrics vary based on CCT and lensing; see vltcorp.com for output conversion and other data specific to your fixture choices.

AVAILABLE IN LENGTHS UP TO 95.28" [2420MM]



(Beam Angle based on 1QL fixture with Clear Acrylic lens)

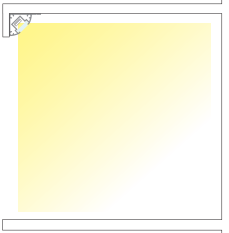


ELC-1QL -

<b>LED</b>		<b>Finish</b>		<b>Wire Exit <sup>2</sup></b>		<b>Listings</b>	
1435	288 lm/ft, 2.7 w/ft, 90+ CRI	AL	Silver Anodized	C	Custom	UL	UL Listed
2435	384 lm/ft, 3.7 w/ft, 90+ CRI	BL	Black Anodized	<sup>2</sup> Because of 1QL's asymmetric form, special care should be taken when specifying Wire Exit.		CE	CE Marked (RoHS)
3435	478 lm/ft, 5.5 w/ft, 90+ CRI					<b>Fixture Length</b>	
■ Narrow Pitch Choice LEDs		<b>CCT</b>		<b>Lens Options</b>		See Fixture Length and Wattage Table. Choose the correct Code number for the LED board and fixture length of your choice or specify Custom Length as follows: C (12.25") or C [311mm]	
		23	2300°K	PG	Clear Acrylic		
		27	2700°K	OP1	Opal 1, Frosted		
		30	3000°K	OP2	Opal 2, Medium		
		35	3500°K	OP3	Opal 3, Heavy <sup>1</sup>		
		40	4000°K				

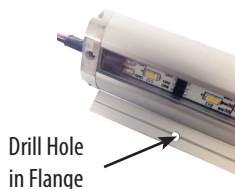
<sup>1</sup>Not Title 24 JA8-2016 compliant

1QL tucked behind lighting valance



**1QL's** self-contained mounting flange allows the fixture to fit tightly into corners, with a 94° beam angle and wide field angle for fully lighting shelf and undercabinet spaces. 1QL can tuck neatly behind a lighting valance, as illustrated at left, or if no valance is provided, 1QL can mount flush with the front edge of the shelf or cabinet. The fixture's slim, finished back surface ensures an attractive presentation, as shown in the photos to the right.

The 1QL flange is scored for easy drilling; mounting holes should be drilled approximately every 20" (minimum two holes per fixture). The 1QL fixture can also be mounted using VHB tape.



1QL mounted on shelf edge



When visible, the slim 1QL fixture adds an attractive accent to cabinetry



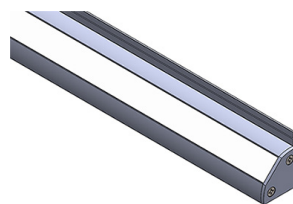


## New! 2QL CHOICE QUARTER ROUND EXTRUSION - LENSED

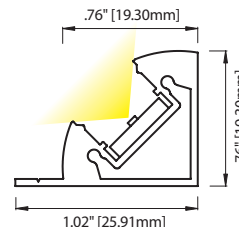
2QL Choice: IP40 | Quarter Round extrusion fits snugly into corners for bright, even linear lighting. UL Listed dry/damp. Includes selection of 7 LED Boards with EssentialLEDs Choice LEDs on a Narrow Pitch. See lumen outputs, CCTs, wattage and other variables on Choice Linear Fundamentals.

Available in Silver or Black Finishes. Choice of Clear Acrylic lens (standard), or 3 Opal diffusion lenses. Photometrics vary based on CCT and lensing; see vltcorp.com for output conversion and other data specific to your fixture choices.

AVAILABLE IN LENGTHS UP TO 95.28" [2420MM]



(Beam Angle based on 2QL fixture with Clear Acrylic lens)



### ELC- 2QL -

#### LED

1435	288 lm/ft, 2.7 w/ft, 90+ CRI <sup>2</sup>
2435	384 lm/ft, 3.7 w/ft, 90+ CRI <sup>2</sup>
3435	478 lm/ft, 5.5 w/ft, 90+ CRI <sup>2</sup>
4435	610 lm/ft, 5.8 w/ft, 90+ CRI <sup>2</sup>
1320	222 lm/ft, 2.0 w/ft, 95+ CRI <sup>1</sup>
2320	335 lm/ft, 2.8 w/ft, 95+ CRI <sup>1</sup>
4320	590 lm/ft, 5.9 w/ft, 95+ CRI <sup>1</sup>

- Narrow Pitch Choice LEDs
- Standard Pitch Nichia LEDs

<sup>1</sup> Not Available in 23K CCT  
<sup>2</sup> Not Available in 45K CCT

#### Finish

AL	Silver Anodized
BL	Black Anodized

#### Wire Exit

C	Custom
---	--------

#### Listings & Options

UL	UL Listed	
CE	CE Marked (RoHS)	

#### CCT

23	2300°K
27	2700°K
30	3000°K
35	3500°K
40	4000°K
45	4500°K

#### Lens Options

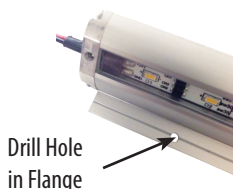
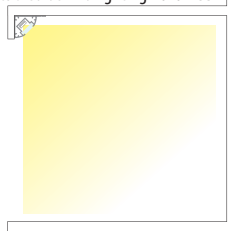
PG	Clear Acrylic
OP1	Opal 1, Frosted
OP2	Opal 2, Medium <sup>3</sup>
OP3	Opal 3, Heavy <sup>3, 4</sup>

<sup>3</sup> Will provide full diffusion  
<sup>4</sup> Not Title 24 JA8-2016 compliant

#### Fixture Length

See Fixture Length and Wattage Table. Choose the correct Code number for the LED board and fixture length of your choice or specify Custom Length as follows: C (12.25") or C [311mm]

2QL tucked behind lighting valance



**2QL's** self-contained mounting flange allows the fixture to fit tightly into corners, with a 94° beam angle and wide field angle for fully lighting shelf and undercabinet spaces. 2QL can tuck neatly behind a lighting valance, as illustrated at left, or if no valance is provided, 2QL can mount flush with the front edge of the shelf or cabinet. The fixture's slim, finished back surface ensures an attractive presentation, as shown in the photos to the right.

The 2QL flange is scored for easy drilling; mounting holes should be drilled approximately every 20" (minimum two holes per fixture). The 2QL fixture can also be mounted using VHB tape.

2QL mounted on shelf edge



When visible, the slim 2QL fixture adds an attractive accent to cabinetry



**New!** 1R CHOICE SMALL ROUND EXTRUSION - NO LENS

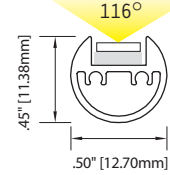
1R Choice: IP20 | Round extrusion for linear lighting applications. Includes selection of 3 LED Boards with EssentialLEDs Choice LEDs on a Narrow Pitch. See lumen outputs, CCTs, wattage and other variables on Choice Linear Fundamentals.

Available in Silver or Black Finishes. No lens. Refer to Mounting Options for other possible choices. Photometrics vary based on CCT; see vltcorp.com for output conversion and other data specific to your fixture choices.

AVAILABLE IN LENGTHS UP TO 95.28" [2420MM]



OBSERVE PRECAUTIONS FOR HANDLING ELECTROSTATIC SENSITIVE DEVICES



ELC- 1R -

LED		Finish		Wire Exit		Listings & Options <sup>1</sup>	
1435	288 lm/ft, 2.7 w/ft, 90+ CRI	AL	Silver Anodized	WE1	Default	UL	UL Listed
2435	384 lm/ft, 3.7 w/ft, 90+ CRI	BL	Black Anodized	C	Custom	CE	CE Marked (RoHS)
3435	478 lm/ft, 5.5 w/ft, 90+ CRI	C	Custom			IM	Inside Mount End Caps <sup>1</sup>
■ Narrow Pitch Choice LEDs						EM8	8mm End Mount Leg <sup>1</sup>
CCT		Lens Options		Fixture Length		TM8	8mm T-Mount Leg <sup>1</sup>
23	2300°K	NL	No Lens	See Fixture Length and Wattage Table. Choose the correct Code number for the LED board and fixture length of your choice or specify Custom Length as follows: C (12.25") or C [311mm]		CM8	8mm Corner Mount Leg <sup>1</sup>
27	2700°K					BU	Bushing <sup>1</sup>
30	3000°K						
35	3500°K						
40	4000°K						

<sup>1</sup> Finish on Factory Installed Options will match specified finish; see Mounting Options.

See Special Mounting Options for more information about specifying 1R fixtures in Display Case

Basic Fixture Accessories - See Mounting Options For Full Options

ELL - AC - 1R - PC	ELL - AC - 1R - LC	ELL - AC - 1R - SALC	ELL - AC - 1R - MRC
<b>Plastic Mounting Clip;</b> extrusion rotates into clip. Extrusion sits 1/16" (1.59mm) off mounting surface. See Mounting Options.	<b>Locking Adjustable Mounting Clip;</b> use one at each end of extrusion, alone or with Plastic Clips; 4-40 set screws lock extrusion at desired angle. Extrusion sits 1/16" (1.59mm) off mounting surface. See Mounting Options.	<b>Locking Adjustable Self-Adhesive Clip;</b> use alone or with Plastic Clips; attaches with VHB tape; 4-40 set screws lock extrusion at desired angle. Extrusion sits 1/16" (1.59mm) off mounting surface. See Mounting Options.	<b>Metal Mounting Clip;</b> Fixture extrusion rotates into clip. Countersunk screw-hole so fixture sits flush to mounting surface. Allows 60° rotation. Allow 1 per 12" (min. 2 per fixture); Polished Nickel Finish; See Mounting Options.



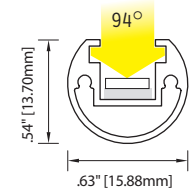
## New! 2RL CHOICE LARGE ROUND EXTRUSION - LENSED

2RL Choice: IP40 | Round extrusion for linear lighting applications. UL Listed dry/damp. Includes selection of 3 LED Boards with EssentialLEDs Choice LEDs on a Narrow Pitch. See lumen outputs, CCTs, wattage and other variables on Choice Linear Fundamentals.

Available in Silver or Black Finishes. Choice of Clear Acrylic lens (standard), or 3 Opal diffusion lenses. Refer to Mounting Options for other possible choices. Photometrics vary based on CCT and lensing; see vltcorp.com for output conversion and other data specific to your fixture choices.



(Beam Angle based on 2RL fixture with Clear Acrylic lens)



AVAILABLE IN LENGTHS UP TO 95.28" [2420MM]

ELC-2RL -

LED		Finish		Wire Exit		Listings & Options	
1435	288 lm/ft, 2.7 w/ft, 90+ CRI	AL	Silver Anodized	WE1	Default	UL	UL Listed
2435	384 lm/ft, 3.7 w/ft, 90+ CRI	BL	Black Anodized	C	Custom	CE	CE Marked (RoHS)
3435	478 lm/ft, 5.5 w/ft, 90+ CRI					IM	Inside Mount End Caps <sup>1</sup>
Narrow Pitch Choice LEDs						EM8	8mm End Mount Leg <sup>1</sup>
						TM8	8mm T-Mount Leg <sup>1</sup>
						CM8	8mm Corner Mount Leg <sup>1</sup>
						EM16	16mm End Mount Leg <sup>1</sup>
						TM16	16mm T-Mount Leg <sup>1</sup>
						CM16	16mm Corner Mount Leg <sup>1</sup>
						BU	Bushing <sup>1</sup>

CCT

23	2300°K
27	2700°K
30	3000°K
35	3500°K
40	4000°K

Lens Options

PG	Clear Acrylic
OP1	Opal 1, Frosted
OP2	Opal 2, Medium
OP3	Opal 3, Heavy <sup>1</sup>

<sup>1</sup> Not Title 24 JA8-2016

Fixture Length

See Fixture Length and Wattage Table. Choose the correct Code number for the LED board and fixture length of your choice or specify Custom Length as follows: C (12.25") or C (311mm)

<sup>1</sup> Finish on Factory Installed Options will match specified finish; see Mounting Options.

See Special Mounting Options for more information about specifying 2RL fixtures in Display Case

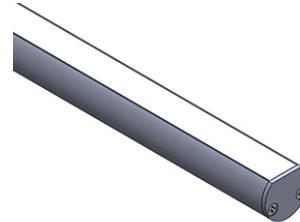
### Basic and Free Standing Fixture Accessories - See Mounting Options For Full Options

ELL - AC - 2RL - PC	ELL - AC - 2RL - LC	ELL - AC - 2RL - SALC	ELL - AC - 2RL - MRC
<b>Plastic Mounting Clip;</b> Fixture extrusion rotates into clip. Screws to mounting surface. Raises fixture 0.13" (3.18mm). Allows 30° rotation. Allow 1 per 12" (min. 2 per fixture); See Mounting Options.	<b>Locking Adjustable Mounting Clip;</b> Screws to mounting surface. Raises fixture 0.13" (3.18mm). Full rotation with locking screw. Finishes to match fixture. Allow 2 per fixture (48" max span). See Mounting Options.	<b>Locking Adjustable Mounting Clip with Self-Adhesive.</b> Raises fixture 0.13" (3.18mm). Full rotation with locking screw. Finishes to match fixture. Allow 2 per fixture (48" max span). See Mounting Options.	<b>Metal Mounting Clip;</b> Fixture extrusion rotates into clip. Countersunk screw-hole so fixture sits flush to mounting surface. Allows 60° rotation. Allow 1 per 12" (min. 2 per fixture); Polished Nickel Finish; See Mounting Options.

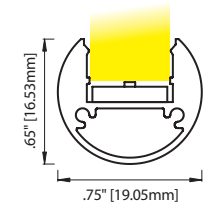
**New!** 3RL CHOICE LARGE ROUND EXTRUSION - LENSED

3RL Choice: IP40 | Round extrusion for linear lighting applications. UL Listed dry/damp. Includes selection of 7 LED Boards with EssentialLEDs Choice LEDs on a Narrow Pitch. See lumen outputs, CCTs, wattage and other variables on Choice Linear Fundamentals.

Available in Silver or Black Finishes. Choice of Clear Acrylic lens (standard), or 3 Opal diffusion lenses. Refer to Mounting Options for other possible choices. Photometrics vary based on CCT and lensing; see vltcorp.com for output conversion and other data specific to your fixture choices.



(Beam Angle based on 3RL fixture with Clear Acrylic lens)



ELC- 3RL -

LED		Finish		Wire Exit		Listings & Options	
1435	288 lm/ft, 2.7 w/ft, 90+ CRI <sup>2</sup>	AL	Silver Anodized	WE1	Default	UL	UL Listed
2435	384 lm/ft, 3.7 w/ft, 90+ CRI <sup>2</sup>	BL	Black Anodized	C	Custom	CE	CE Marked (RoHS)
3435	478 lm/ft, 5.5 w/ft, 90+ CRI <sup>2</sup>						
4435	610 lm/ft, 5.8 w/ft, 90+ CRI <sup>2</sup>						
1320	222 lm/ft, 2.0 w/ft, 95+ CRI <sup>1</sup>						
2320	335 lm/ft, 2.8 w/ft, 95+ CRI <sup>1</sup>						
4320	590 lm/ft, 5.9 w/ft, 95+ CRI <sup>1</sup>						
		CCT		Lens Options		Fixture Length	
		23	2300°K	PG	Clear Acrylic	See Fixture Length and Watage Table. Choose the correct Code number for the LED board and fixture length of your choice or specify Custom Length as follows: C (12.25") or C [311mm]	
		27	2700°K	OP1	Opal 1, Frosted		
		30	3000°K	OP2	Opal 2, Medium <sup>3</sup>		
		35	3500°K	OP3	Opal 3, Heavy <sup>3, 4</sup>		
		40	4000°K				
		45	4500°K				

<sup>1</sup> Not Available in 23K CCT  
<sup>2</sup> Not Available in 45K CCT  
<sup>3</sup> Will provide full diffusion  
<sup>4</sup> Not Title 24 JA8-2016

■ Narrow Pitch Choice LEDs  
■ Standard Pitch Nichia LEDs

See Special Mounting Options for more information about specifying 2RL fixtures in Display Case

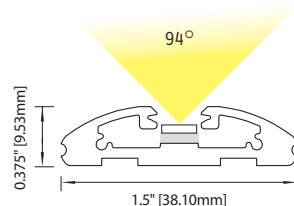
Basic and Free Standing Fixture Accessories - See Mounting Options For Full Options			
ELL - AC - 3RL - PC	ELL - AC - 3RL - LC	ELL - AC - 3RL -SALC	ELL - AC - 3RL - MRC
<b>Plastic Mounting Clip;</b> Fixture extrusion rotates into clip. Screws to mounting surface. Raises fixture 0.13" (3.18mm). Allows 30° rotation. Allow 1 per 12" (min. 2 per fixture); See Mounting Options.	<b>Locking Adjustable Mounting Clip;</b> Screws to mounting surface. Raises fixture 0.13" (3.18mm). Full rotation with locking screw. Finishes to match fixture. Allow 2 per fixture (48" max span). See Mounting Options.	<b>Locking Adjustable Mounting Clip with Self-Adhesive.</b> Raises fixture 0.13" (3.18mm). Full rotation with locking screw. Finishes to match fixture. Allow 2 per fixture (48" max span). See Mounting Options.	<b>Metal Mounting Clip;</b> Fixture extrusion rotates into clip. Countersunk screw-hole so fixture sits flush to mounting surface. Allows 60° rotation. Allow 1 per 12" (min. 2 per fixture); Polished Nickel Finish; See Mounting Options.

## New! 1EL CHOICE DEMI-ELLIPSE EXTRUSION - LENSED

1EL Choice: IP20 | Demi-Ellipse extrusion provides a low-profile fixture with recessed LED board to minimize side-view glare. Includes selection of 3 LED Boards with EssentialLEDs Choice LEDs on a Narrow Pitch. See lumen outputs, CCTs, wattage and other variables on Choice Linear Fundamentals.

Available in Silver or Black Finishes. Diffuser Film Lens. Photometrics vary based on CCT; see vltcorp.com for output conversion and other data specific to your fixture choices.

AVAILABLE IN LENGTHS UP TO 95.28" [2420MM]



ELC- 1EL -

### LED

1435	288 lm/ft, 2.7 w/ft, 90+ CRI
2435	384 lm/ft, 3.7 w/ft, 90+ CRI
3435	478 lm/ft, 5.5 w/ft, 90+ CRI

■ Narrow Pitch Choice LEDs

### Finish

AL	Silver Anodized
BL	Black Anodized

### Wire Exit

WE1	Default
C	Custom

### Listings & Options

UL	UL Listed	
CE	CE Marked (RoHS)	
FEC	Flange End Cap	

### CCT

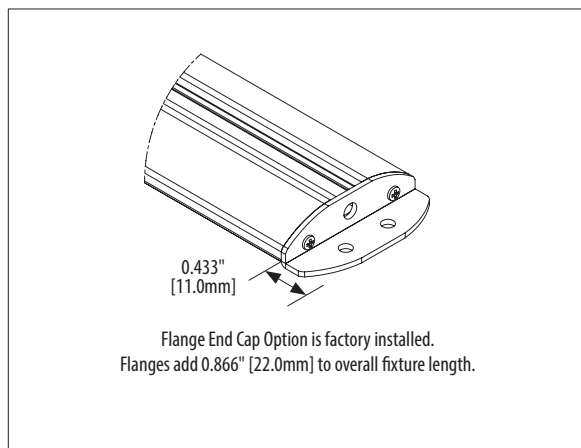
23	2300°K
27	2700°K
30	3000°K
35	3500°K
40	4000°K

### Lens Options

DF	Diffuser Film
----	---------------

### Fixture Length

See Fixture Length and Wattage Table. Choose the correct Code number for the LED board and fixture length of your choice or specify Custom Length as follows: C (12.25") or C [311mm]



### Fixture Accessories

ELL - AC - 1EL - MC



**Fixed Metal Mounting Clip;** Fixture snaps into clip. Countersunk screw-holes allow fixture to sit flush to mounting surface. Allow 1 clip per 12" (min. 2 per fixture). See Mounting Options.

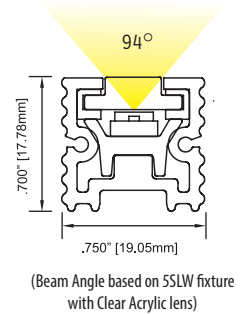
**New!** 5SLW CHOICE SQUARE EXTRUSION - EXTERIOR

5SLW Choice: UL Listed for Wet Locations | Square extrusion suitable for wet location linear lighting applications, both indoors and outdoors.<sup>1</sup> Includes selection of 3 LED Boards with EssentialLEDs Choice LEDs on a Narrow Pitch. See lumen outputs, CCTs, wattage and other variables on Choice Linear Fundamentals.

Available in Silver or Black Finishes. Photometrics vary based on CCT and lensing; see vltcorp.com for conversion and other data specific to your fixture choices.

<sup>1</sup> A wet location is an interior or exterior location in which water or other liquids may drip, splash or flow on or against the electrical components of a lighting fixture

AVAILABLE IN LENGTHS UP TO 72.29" [1836MM]



ELC- 5SLW -

LED		Finish		Wire Exit		Listings	
1435	288 lm/ft, 2.7 w/ft, 90+ CRI	AL	Silver Powder Coat	WE1R	4' Bare End	UL	UL Listed
2435	384 lm/ft, 3.7 w/ft, 90+ CRI	BL	Black Powder Coat			CE	CE Marked (RoHS)
3435	478 lm/ft, 5.5 w/ft, 90+ CRI						

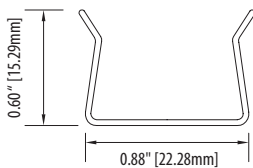
Narrow Pitch Choice LEDs

CCT		Lens Options		Fixture Length	
23	2300°K	PG	Clear Acrylic	See Fixture Length and Wattage Table. Choose the correct Code number for the LED board and fixture length of your choice.	
27	2700°K	OP1	Opal 1, Frosted		
30	3000°K				
35	3500°K				
40	4000°K				

FIXED CLIP

SPECIFICATIONS

CAT. NO. ELL-AC-5SLW-MC



Dimensions: 0.88" [22.28mm] x 0.60" [15.29mm]

Material: 301 Stainless Steel

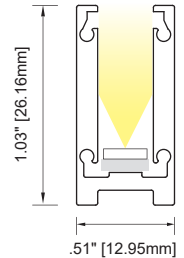
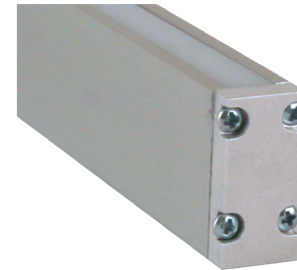
**Description:** Fixed Metal Clip for mounting 5SLW square extrusion. Screws to mounting surface with screw, provided. Fixture extrusion snaps into clip. Allow 1 per 20" of extrusion (min. 2 per fixture).



## New! 4SL CHOICE MEDIUM SQUARE TALL EXTRUSION - LENSED

4SL Choice: IP40 | Square extrusion with 1" depth capable of full diffusion of LED diodes. Use decoratively for a slim (9/32") visible line of diffused light, or light up polished surfaces without reflected diodes. UL Listed dry/damp. Includes selection of 3 LED Boards with EssentialLEDs Choice LEDs on a Narrow Pitch. See lumen outputs, CCTs, wattage and other variables on Choice Linear Fundamentals.

Available in Silver or Black Finishes. Choice of 3 Opal diffusion lenses. Opal 2 (Medium) or Opal 3 (Heavy) required for full diffusion. Photometrics vary based on CCT and lensing; see vltcorp.com for conversion and other data specific to your fixture choices.



AVAILABLE IN LENGTHS UP TO 95.28" [2420MM]

LED		Finish		Wire Exit		Listings & Options	
1435	288 lm/ft, 2.7 w/ft, 90+ CRI	AL	Silver Anodized	WE1	Default	UL	UL Listed
2435	384 lm/ft, 3.7 w/ft, 90+ CRI	BL	Black Anodized	C	Custom	CE	CE Marked (RoHS)
3435	478 lm/ft, 5.5 w/ft, 90+ CRI	C	Custom			MAG	Magnetic Mount

CCT		Lens Options		Fixture Length	
23	2300°K	OP1	Opal 1, Frosted	See Fixture Length and Wattage Table. Choose the correct Code number for the LED board and fixture length of your choice or specify Custom Length as follows: C (12.25") or C [311mm]	
27	2700°K	OP2	Opal 2, Medium <sup>1</sup>		
30	3000°K	OP3	Opal 3, Heavy <sup>1,2</sup>		
35	3500°K				
40	4000°K				

<sup>1</sup> Will provide full diffusion  
<sup>2</sup> Not Title 24 JA8-2016 compliant

Narrow Pitch Choice LEDs

### Fixture Accessories

ELL - AC - 4SL - MC	ELL - AC - 4SL - AMC	ELL - AC - S123 - AB	ELL - AC - 4SL - WCR - AL	Factory Installed; See Options Above
<b>Fixed Metal Mounting Clip</b> Fixture extrusion snaps into clip. Allow 1 per 12" (min. 2 per fixture). See Mounting Options.	<b>Adjustable Metal Mounting Clip</b> Offset screws allow flush mounting. Bends to desired angle. Allow 1 per 12" (min. 2 per fixture). See Mounting Options.	<b>Adjustable Metal Bracket</b> for use with Fixed Metal Mounting Clip (one bracket per clip). 30° adjustability. Raises fixture 3/8" (9.52mm). Bracket allows repeated angle adjustments and easier angle adjustments in hard-to-reach areas like ceiling covers. See Mounting Options.	<b>Wall / Ceiling Mounting Rough-in;</b> Specify length to match fixture length. 8-32 flat head screw allows height adjustment for flush installation. (Not walk-over or drive-over rated). See Special Mounting Options.	<b>Magnetic Mount</b> Factory-installed magnets hold fixture securely to ferrous surface or accessory <b>Steel Mounting Plates</b> (see Mounting Options); 3 magnets per foot, factory installed. Magnets protrude 0.09" [2.3mm] above rear surface of extrusion.

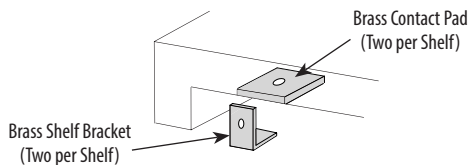
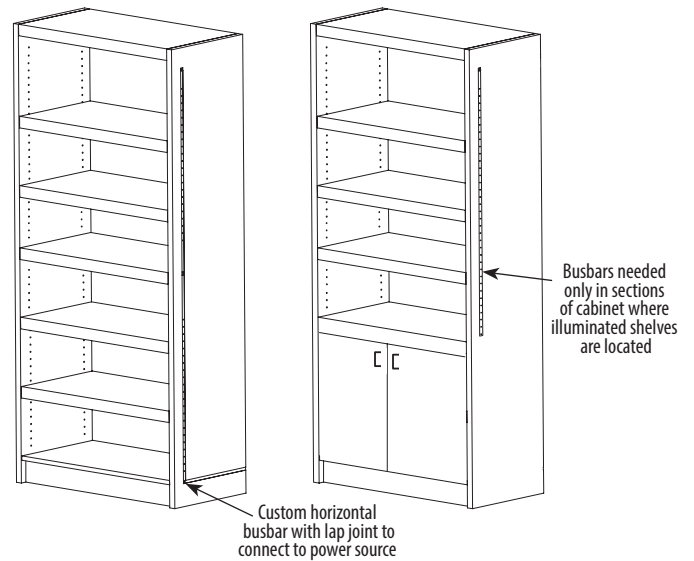
*CHOICE / LINEAR  
ACCESSORIES &  
INFORMATION*

**New!** ESSENTIALEDGE ADJUSTABLE SHELF LIGHTING SYSTEM



The four components below are required to create a shelving unit with adjustable shelves that will light up in any position where they are placed. Each shelving unit requires two busbars to be installed on each side of the unit; busbars are needed only for sections of the unit where illuminated shelves are desired. After installation, busbars can be covered by laminate or veneer, or concealed by adjacent cabinetry. Each adjustable shelf requires two (2) Brass Contact Pads and two (2) Brass Shelf Brackets. Two (2) Lug Ring Connectors are required to connect driver to busbars. See Cut Sheet #9X254 for full installation instructions.

**EssentialLEDs linear fixtures must be specified with ASWE wire exit.**

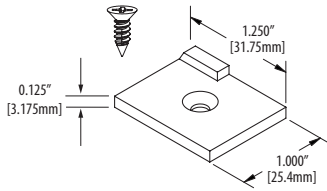


STANDARD BUSBAR	SPECIFICATIONS	CAT. NO.	ELL - AS - SBB -
	<p>Dimensions: 0.500" x 0.125" x Length [12.7mm x 3.175mm x Xmm]</p> <p>Material: Brass</p>		<div style="border: 1px solid black; padding: 2px;">                     3 ft. 6 ft. C                 </div>
	<p><b>Description:</b> Conductive brass busbar with threaded holes (8-32) spaced every 32mm OC. Each shelving unit requires two (2) Busbars, one on each side of unit.</p> <p>System is intended for installation in new cabinetry or millwork only; each cabinet requires milling out of symmetrical channels (depth of 0.150" [3.81mm]) on each side of unit for installation of busbars.</p> <p>Available in 3' [914.4mm], 6' [1828.8mm] or Custom length (C).</p>		
CUSTOM VERTICAL BUSBAR W/ LAP JOINT	SPECIFICATIONS	CAT. NO.	ELL - AS - CVB
	<p>Size: 0.500" x 0.125" x Length [12.7mm x 3.175mm x Xmm]</p> <p>Material: Brass</p>		
	<p><b>Description:</b> Custom vertical busbar with lap joints to allow addition of horizontal busbar; threaded holes (8-32) spaced every 32mm OC. Contact factory for help to specify.</p>		
CUSTOM HORIZONTAL BUSBAR W/ LAP JOINT	SPECIFICATIONS	CAT. NO.	ELL - AS - CHB
	<p>Size: 0.500" x 0.125" x Length [12.7mm x 3.175mm x Xmm]</p> <p>Material: Brass</p>		
	<p><b>Description:</b> Custom horizontal busbar with lap joint to allow connection to vertical busbar. Contact factory for help to specify.</p>		
LUG RING CONNECTOR & SCREW	SPECIFICATIONS	CAT. NO.	ELL - AS - LRC
	<p>Size: 22-16</p> <p>Material: Tin/copper connector Nylon insulation</p>		
	<p><b>Description:</b> Lug ring connector attaches positive and negative wires from driver to busbar to power lighting fixtures. Screw and washer included. System requires two (2) lug ring connectors per driver.</p>		



BRASS CONTACT PAD W/ CONNECTOR      SPECIFICATIONS      CAT. NO.      ELL - AS - CP -  -

L     BRF  
 R     NLP



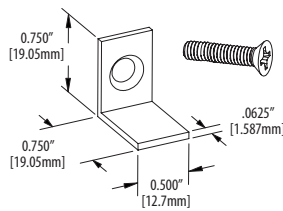
Dimensions: 1.250" x 1.000" x 0.125"  
[31.75mm x 25.4mm x 3.175mm]  
Material: Brass pad, plastic connector  
Connector: Wago Single Pole

**Description:** Brass contact pad with Wago connector & screw for installation on underside of each shelf in Adjustable Shelf Lighting System. Pocket for each contact pad should be milled to depth of .120" [3.048mm] to ensure flush surface on underside of shelf. Wires from lighting fixture are inserted into Wago connectors to power fixture.

System requires two (2) contact pads per shelf, one left, one right. Available in Brass or Nickel-Plated finish.

BRASS SHELF BRACKET & SCREW      SPECIFICATIONS      CAT. NO.      ELL - AS - SB -

BRF  
 NLP



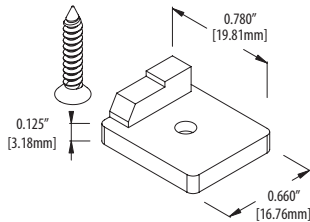
Dimensions: 0.750" x 0.750" x 0.500"  
[19mm x 19mm x 12mm]  
Material: Brass

**Description:** Brass shelf bracket with brass screw for use with Adjustable Shelf Lighting System. Brass screw threads into busbar to conduct low voltage power from driver to lighting fixture. Brass brackets and screws are required only in the holes that are connected to the busbar; ordinary shelf brackets can be used for the other supports.

System requires two (2) brass shelf brackets & screws per shelf. Available in Brass or Nickel-Plated finish.

PRO SERIES BRASS CONTACT PAD W/ CONNECTOR      SPECIFICATIONS      CAT. NO.      ELL - AS - PCP -  -

L     BRF  
 R     NLP



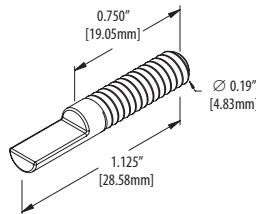
Dimensions: 0.780" x 0.660" x 0.125"  
[19.81mm x 16.76mm x 3.18mm]  
Material: Brass

**Description:** Pro Series Brass contact pad with Wago connector & screw for installation on underside of each shelf in Adjustable Shelf Lighting System. Pocket for each contact pad should be milled to depth of .120" [3.048mm] to ensure flush surface on underside of shelf. Wires from lighting fixture are inserted into Wago connectors to power fixture.

Pro Series components require precise placement within millwork to ensure contact. Pro Series requires two (2) contact pads per shelf, one left, one right.

PRO SERIES BRASS MOUNTING PIN      SPECIFICATIONS      CAT. NO.      ELL - AS - PSB -

BRF  
 NLP



Dimensions: 0.19" x 1.125"  
[4.83mm x 28.58mm]  
Material: Brass

**Description:** Pro Series Brass mounting pin for use with Adjustable Shelf Lighting System. Brass screw threads into busbar to conduct low voltage power from driver to lighting fixture. Brass brackets and screws are required only in the holes that are connected to the busbar; ordinary shelf brackets can be used for the other supports.

Pro Series components require precise placement within millwork to ensure contact. Pro Series requires two (2) contact mounting pins per shelf. Available in Brass or Nickel-Plated finish.

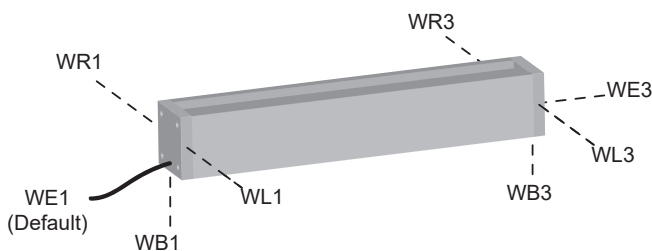
## WIRE EXITS & DAISY CHAINED FIXTURES

### SQUARE EXTRUSIONS

- ML1\*
- 1S\*
- 4SL
- 7SL
- 8SL
- 8CL
- 8FL
- 9SL
- 5SLW\*
- LR
- MLR\*

\*(ML1, 1S, 5SLW & MLR extrusions available with WE1 or WE3 options ONLY.)

(LR = LightRun, MLR = Mini LightRun)



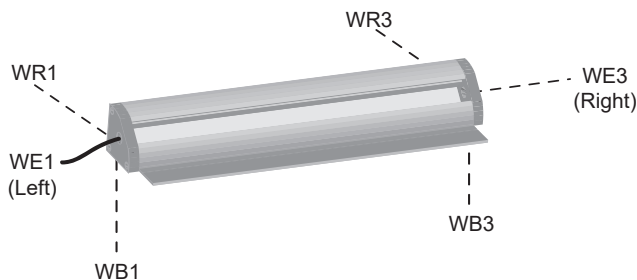
### ROUND EXTRUSIONS

- 1R
- 2RL
- 3RL



### QUARTER ROUND EXTRUSION

- 1QL
- 2QL



### DEMI-ELLIPSE EXTRUSION

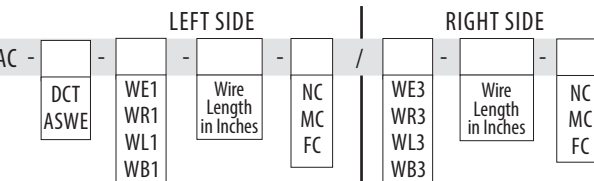
- 1EL



**To Specify "Daisy-Chained" Configurations:** In certain applications, "Daisy-Chained" configurations provide the best wiring solution. Specify the following "Daisy-Chain Termination" Modification for EVERY fixture needing to be daisy-chained; refer to the correct diagrams above for available Wire Exit options: See example below. Daisy-Chained lengths CANNOT exceed a TOTAL of 88 watts per run! (Choice up to 44 watts.)

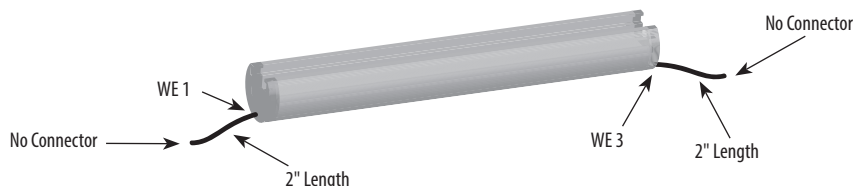
#### DAISY-CHAIN TERMINATION

CAT. NO.



Specify two wire exits, two wire lengths, and two connectors for each fixture to be daisy-chained.

Sample specification: ELL - AC - DCT - WE1 - 2" - NC / WE3 - 2" - NC

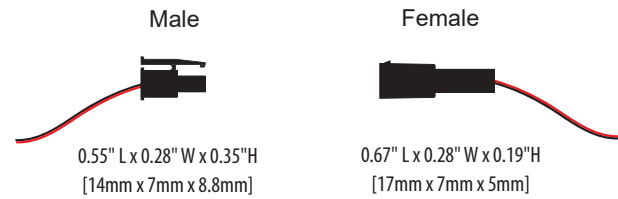


NC	No Connector
MC	Male Connector
FC	Female Connector

CONSTANT VOLTAGE WIRING ACCESSORIES 

CONNECTORS

Fixtures come with 96" [2.44m] of 20 AWG wire and male Tyco Mate 'n Lock connector as standard; customization available; connector can be removed for hard wired installation. Starter, splitter and interconnect wiring accessories available for easy installation; see below.

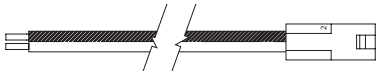



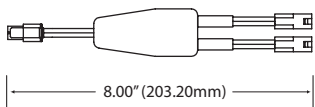



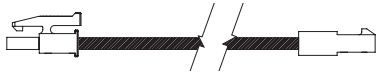





**Starter Cables** have bare wires on one end to connect directly to LED driver terminals or to wires via wire nuts, and one (1) female connector for connection to a linear fixture, splitter accessory, or interconnect wire.

**Splitters** connect multiple fixtures to a single driver; 2- way, 4-way or 8-way options; one (1) male connector, multiple female connectors.

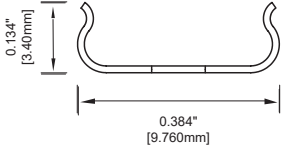
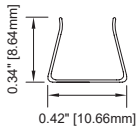
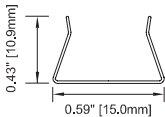
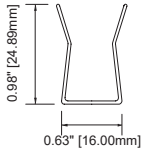
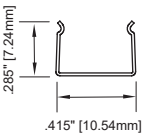
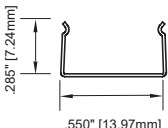
**Interconnect Wires** extend wiring between driver and fixture or between splitter accessory and fixture; (1) one female connector, (1) one male connector.

**All Wiring Accessories are UL Listed (UL 2108), when used as part of an EssentialLEDs® system.**

2 FT or 8 FT STARTER CABLE	SPECIFICATIONS	CAT. NO. ELL - AC - CV - SC -	
	<p><b>Description:</b> Starter Cable with bare wires on one end and a female connector on the other. Bare wires connect to LED driver terminals or to other wires (via wire nuts, not included). Female connector is for direct connection to an EssentialLEDs® Linear fixture, a Splitter or an Interconnect Wire. 20 AWG wire. Available in 2' or 8' lengths.</p> <p> c  us </p>		2 8
<p>2-, 4- or 8- WAY SPLITTER</p> 	<p><b>Description:</b> Wire Splitter with 1 male connector and 2, 4 or 8 multiple female connectors. Allows for easy connection of multiple fixtures to a single LED Driver. Male connector is for connection to a Starter Cable, another Splitter or an Interconnect Wire. Female connectors are for direct connections to an EssentialLEDs® Linear fixtures, other Splitters or Interconnect Wires. Overall length is 8" with each female connector being 3" long. 20 AWG wire.</p> <p> c  us </p>	CAT. NO. ELL - AC - CV - SPL -	2 4 8
<p>INTERCONNECT WIRES</p> 	<p><b>Description:</b> Interconnect Wire with 1 male and 1 female connector for extending connections between LED Drivers and EssentialLEDs® Linear fixtures or between LED Drivers and Wire Splitters. Also for use in "daisy chain" connections between fixtures (see "Daisy-Chain Termination" on page 36). 20 AWG wire. Available in 2', 4', 5' and 10' lengths.</p> <p> c  us </p>	CAT. NO. ELL - AC - CV - ICW -	2 4 5 10

### MOUNTING OPTIONS

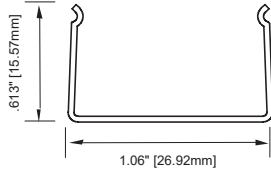
All EssentialLEDs® linear products are ETL listed for both surface and recessed mount applications. ● Options marked by orange dots are factory-installed and must be specified on product configurator.

FIXED METAL CLIP - MLR, ML1	SPECIFICATIONS	CAT. NO. ELL - AC - MLR - MC
	<p>Dimensions: 0.134" x 0.384" [3.40mm x 9.760mm] Material: 301 Stainless Steel</p>	<p><b>Description:</b> Fixed Metal Clip for mounting Mini LightRun extrusion. Screws to mounting surface with screw, provided. Fixture snaps into clip. Allow 1 per 12" of extrusion (min. 2 per fixture).</p>
	<p>Dimensions: 0.34" x 0.42" [8.64mm x 10.66mm] Material: 301 Stainless Steel</p>	<p><b>Description:</b> Fixed Metal Clip for mounting 1S square fixture with No Lens. Screws to mounting surface with screw, provided. Fixture extrusion snaps into clip. Allow 1 per 12" of extrusion (min. 2 per fixture).</p>
	<p>Dimensions: 0.43" x 0.59" [10.9mm x 15.0mm] Material: 301 Stainless Steel <sup>1</sup>When 1S is specified with Slide-On Lens</p>	<p><b>Description:</b> Fixed Metal Clip for mounting 8CL, 8FL and 1S square fixture when SLC lens is used. Screws to mounting surface with screw, provided. Fixture extrusion snaps into clip. Allow 1 per 12" of extrusion (min. 2 per fixture).</p>
	<p>Dimensions: 0.98" x 0.63" [24.89mm x 16.00mm] Material: 301 Stainless Steel</p>	<p><b>Description:</b> Fixed Metal Clip for mounting extra depth 4SL square fixture. Screws to mounting surface with screw, provided. Fixture extrusion snaps into clip. Allow 1 per 12" of extrusion (min. 2 per fixture).</p>
	<p>Dimensions: .285" x .415" [7.24mm x 10.54mm] Material: 301 Stainless Steel</p>	<p><b>Description:</b> Fixed Metal Clip for mounting 7SL square fixture. Screws to mounting surface with screw, provided. Fixture extrusion snaps into clip. Allow 1 per 12" of extrusion (min. 2 per fixture).</p>
	<p>Dimensions: .285" x .550" [7.24mm x 13.97mm] Material: 301 Stainless Steel</p>	<p><b>Description:</b> Fixed Metal Clip for mounting 8SL square fixture. Screws to mounting surface with screw, provided. Fixture extrusion snaps into clip. Allow 1 per 12" of extrusion (min. 2 per fixture).</p>

FIXED METAL CLIP - 9SL

SPECIFICATIONS

CAT. NO. ELL - AC - 9SL - MC



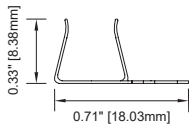
Dimensions: .613" x 1.06" [15.57mm x 26.92mm]  
Material: 301 Stainless Steel

**Description:** Fixed Metal Clip for mounting 9SL square fixture. Screws to mounting surface with screw, provided. Fixture extrusion snaps into clip. Allow 1 per 12" of extrusion (min. 2 per fixture).

ADJUSTABLE METAL CLIP - 1S

SPECIFICATIONS

CAT. NO. ELL - AC - 1S - AMC



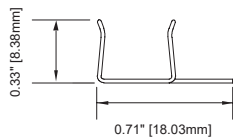
Dimensions: 0.33" x 0.71" [8.38mm x 18.03mm]  
Material: 301 Stainless Steel

**Description:** Adjustable Metal Clip for mounting 1S square extrusion with No Lens. Offset screw plate allows flush mount or one-time adjustment to desired angle. Allow 1 per 12" of extrusion (min. 2 per fixture).

ADJUSTABLE METAL CLIP - 7SL

SPECIFICATIONS

CAT. NO. ELL - AC - 7S - AMC



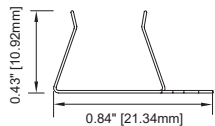
Dimensions: 0.33" x 0.71" [8.38mm x 18.03mm]  
Material: 301 Stainless Steel

**Description:** Fixed Metal Clip for mounting 7SL square fixture. Screws to mounting surface with screw, provided. Fixture extrusion snaps into clip. Allow 1 per 12" of extrusion (min. 2 per fixture).

ADJUSTABLE METAL CLIP - 8SL, 8CL, 8FL & 1S<sup>1</sup>

SPECIFICATIONS

CAT. NO. ELL - AC - 2SL - AMC



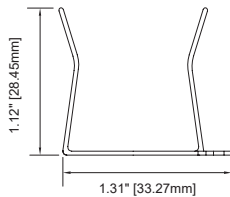
Dimensions: 0.43" x 0.84" [10.92mm x 21.34mm]  
Material: 301 Stainless Steel  
<sup>1</sup> When 1S is specified with Slide-On Lens

**Description:** Adjustable Metal Clip for mounting 8SL, 8CL, 8FL and 1S square extrusion with SLC lens. Offset screw plate allows flush mount or one-time adjustment to desired angle. Allow 1 per 12" of extrusion (min. 2 per fixture).

ADJUSTABLE METAL CLIP - 9SL

SPECIFICATIONS

CAT. NO. ELL - AC - 3SL - AMC



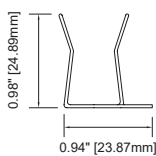
Dimensions: 1.12" x 1.31" [28.45mm x 33.27mm]  
Material: 301 Stainless Steel

**Description:** Adjustable Metal Clip for mounting 9SL square extrusions. Offset screw plate allows flush mount or one-time adjustment to desired angle. Allow 1 per 12" of extrusion (min. 2 per fixture).

ADJUSTABLE METAL CLIP - 4SL

SPECIFICATIONS

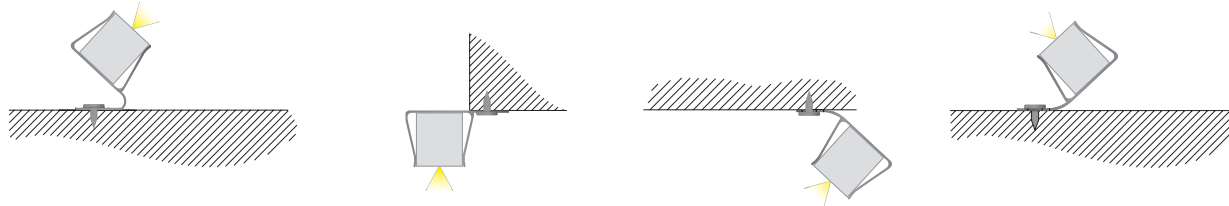
CAT. NO. ELL - AC - 4SL - AMC



Dimensions: 0.98" x 0.94" [24.89mm x 23.87mm]  
Material: 01 Stainless Steel

**Description:** Adjustable Metal Clip for mounting extra depth (4SL) square extrusion. Offset screw plate allows flush mount or one-time adjustment to desired angle. Allow 1 per 12" of extrusion (min. 2 per fixture).

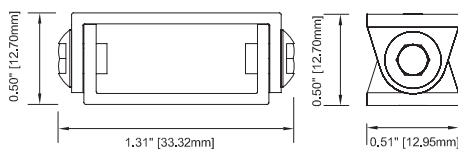
ADJUSTABLE METAL CLIPS FOR 1S, 4SL, 7SL, 8SL, 8CL AND 9SL EXTRUSIONS ALLOW FIXTURES TO BE ATTACHED IN A VARIETY OF MOUNTING SURFACE POSITIONS AND ALLOW ONE-TIME ADJUSTMENT TO DESIRED ANGLE. SEE EXAMPLES BELOW. FIRST PRESS FIXTURE INTO CLIPS, THEN GENTLY BEND CLIPS TO DESIRED ANGLE. NOT INTENDED FOR REPEATED ADJUSTMENTS.



### ADJUSTABLE BRACKET - 1S, 4SL, 7SL, 8SL, 8CL, 9SL

### SPECIFICATIONS

CAT. NO. ELL-AC-S123-AB



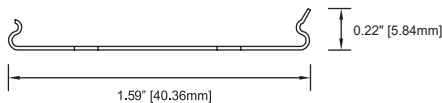
**Dimensions:** 1.31" x 0.51" x 0.50"  
[33.32mm x 12.95mm x 12.7mm]  
**Material:** 304 Stainless Steel

**Description:** Adjustable Metal Bracket for use with Fixed Metal Mounting Clip (one bracket per clip, ordered separately). Allows repeated 30° angle adjustability of 1S, 4SL, 7SL, 8SL, 8CL or 9SL square fixtures. Screws to mounting surface with screw, provided. Raises fixture 3/8" (9.52mm) off mounting surface. Allow 1 per 12" of extrusion (min. 2 per fixture).

### 1EL MOUNTING CLIP

### SPECIFICATIONS

CAT. NO. ELL - AC-1EL - MC



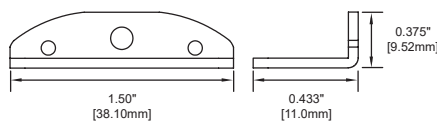
**Dimensions:** 1.59" [40.36mm] x 0.22" [5.84mm]  
**Material:** Stainless Steel

**Description:** Fixed Metal Clip for mounting small (1EL) demi-ellipse extrusion. Countersunk screw-holes allows fixture to mount flush to surface (#4 screws provided). Fixture extrusion snaps into clip. Allow 1 per 12" of extrusion (min. 2 per fixture).

### 1EL- END CAP/FLANGE

### SPECIFICATIONS

CAT. NO. ELL - AC - 1EL - FEC -



**Dimensions:** 1.50" [38.10mm] x 0.433" [11.0mm]  
**Material:** Aluminum

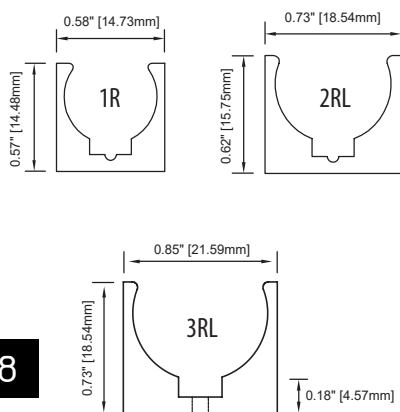
**Description:** Flange End Cap for self-mounting 1EL fixture. Factory installed – must be specified on product configurator. Flange on both ends adds 0.866" [22.0mm] to overall length of fixture. Screws to mounting surface with #4 screw, provided. Silver (AL), Black (BL), Bronze (BZ) or White (WH) finish to match fixture.

AL  
BL  
BZ  
WH

### PLASTIC CLIP - 1R, 2RL, 3RL

### SPECIFICATIONS

CAT. NO. ELL - AC -



**1R Dimensions:** 0.58" x 0.57" [14.73mm x 14.48mm]  
**2RL Dimensions:** 0.73" x 0.62" [18.54mm x 15.75mm]  
**3RL Dimensions:** 0.85" x 0.73" [21.59mm x 18.54mm]  
**Material:** ABS Plastic

**Description:** Plastic Clip for mounting round extrusion. Screws to mounting surface with screw, provided. Fixture extrusion snaps into clip. Raises fixture 0.13" (3.30mm) for 1R and 2RL, 0.18" (4.57mm) for 3RL. Allows 30° rotation. Allow 1 per 12" of extrusion (min. 2 per fixture).

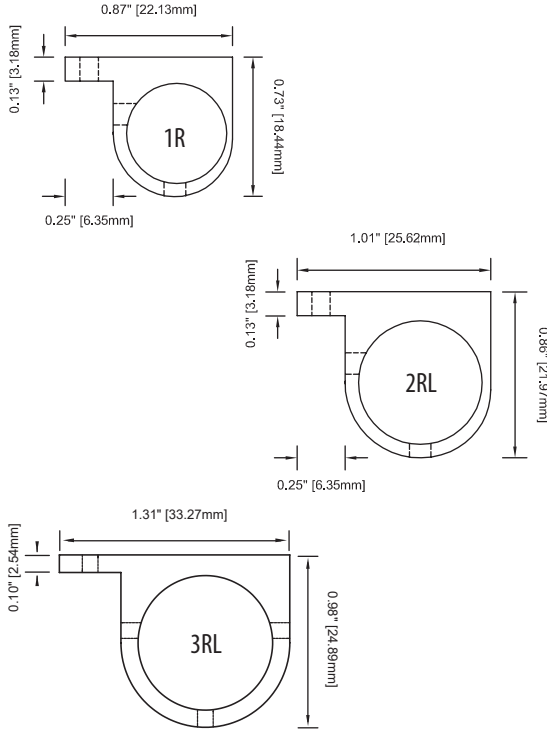
1R  
2RL  
3RL

All EssentialLEDs® linear products are UL listed for both surface and recessed mount applications. ● Options marked by orange dots are factory installed and must be specified on fixture configurator.

LOCKING CLIP - 1R, 2RL, 3RL

SPECIFICATIONS

CAT. NO.	ELL - AC -	- LC -
	1R 2RL 3RL	AL BL BZ WH



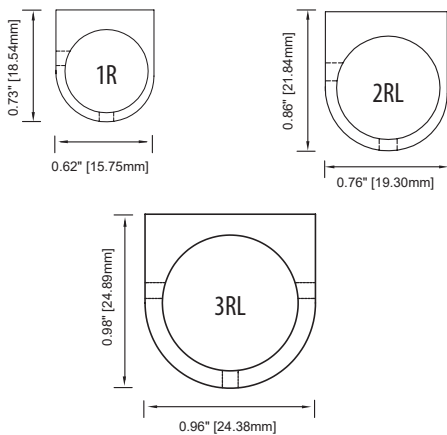
1R Dimensions: 0.87" x 0.73" [22.13mm x 18.44mm]  
 2RL Dimensions: 1.01" x 0.86" [25.62mm x 21.97mm]  
 3RL Dimensions: 1.31" x 0.98" [33.27mm x 24.89mm]  
 Material: Aluminum  
 Finish: Silver (AL), Black (BL), Bronze (BZ)  
 Anodized; White (WH) Powder Coated

**Description:** Locking Adjustable Clip for mounting round extrusion. Screws to mounting surface with screw, provided. Raises fixture 0.13" (3.18mm). Full rotation with locking set screw. Allow 2 per fixture (1 at each end) with 48" [1279.2mm] max span between. Add Plastic Mounting Clips in between for longer spans. Silver (AL), Black (BL), Bronze (BZ) or White (WH) finish to match fixture.

SELF-ADHESIVE LOCKING CLIP - 1R, 2RL, 3RL

SPECIFICATIONS

CAT. NO.	ELL - AC -	- SALC -
	1R 2RL 3RL	AL BL BZ WH



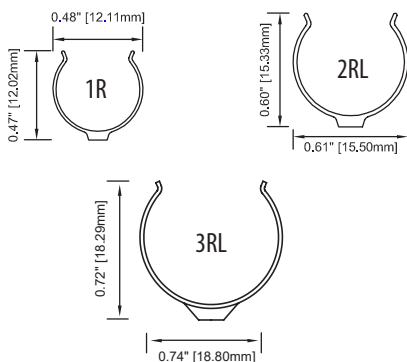
1R Dimensions: 0.62" x 0.73" [15.75mm x 18.54mm]  
 2RL Dimensions: 0.76" x 0.86" [19.30mm x 21.84mm]  
 3RL Dimensions: 0.96" x 0.98" [24.38mm x 24.89mm]  
 Material: Aluminum  
 Finish: Silver (AL), Black (BL), Bronze (BZ)  
 Anodized; White (WH) Powder Coated

**Description:** Locking Adjustable Clip for mounting small (1R) round extrusion. VHB tape provides self-adhesive attachment to any surface. Raises fixture 0.13" (3.18mm). Full rotation with locking set screw. Allow 2 per fixture (1 at each end) with 48" [1279.2mm] max span between. Add Plastic Mounting Clips in between for longer spans. Silver (AL), Black (BL), Bronze (BZ) or White (WH) finish to match fixture.

METAL ROUND CLIP - 1R, 2RL, 3RL

SPECIFICATIONS

CAT. NO.	ELL - AC -	- MRC
	1R 2RL 3RL	



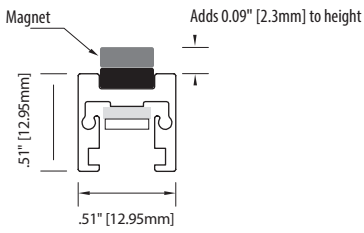
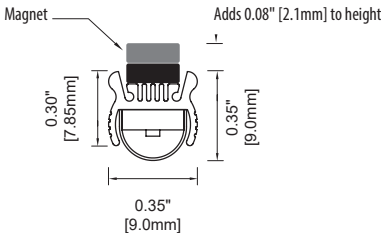
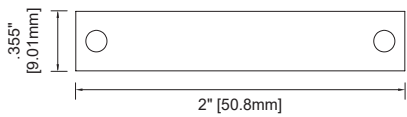
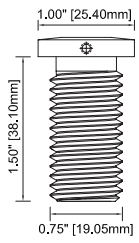
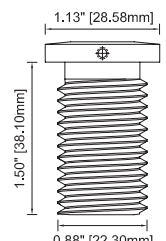
1R Dimensions: 0.48" x 0.47" [12.11mm x 12.02mm]  
 2RL Dimensions: 0.61" x 0.60" [15.50mm x 15.33mm]  
 3RL Dimensions: 0.74" x 0.72" [18.80mm x 18.29mm]  
 Material: 301 Stainless Steel  
 Finish: Polished Nickel

**Description:** Cylindrical Metal Clip for mounting round extrusion. Countersunk screw-holes allows fixture to mount flush to surface (#4 screw provided). Fixture extrusion snaps into clip. Allows 60° rotation. Allow 1 per 20" of extrusion (min. 2 per fixture).



## MOUNTING OPTIONS

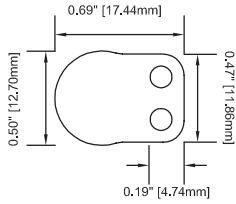
All EssentialLEDs® linear products are UL listed for both surface and recessed mount applications. ● Options marked by orange dots are factory-installed and must be specified on product configurator.

MAGNETIC MOUNT - 4SL, 8SL, 8CL, 8FL, 9SL, LIGHTRUN	SPECIFICATIONS	CAT. NO.	ELL-AC-	-MAG
	<p>Dimensions: Adds 0.09" [2.3mm] to height</p> <p>Material: Sintered Neodymium-Iron-Boron</p> <p>Plating: (NdFeB)Ni-Cu--Ni (Nickel)</p>			<div style="border: 1px solid black; padding: 2px;">                     4SL 8SL 8CL 8FL 9SL LR                 </div>
	<p>Dimensions: Adds 0.08" [2.1mm] to height</p> <p>Material: Sintered Neodymium-Iron-Boron</p> <p>Plating: (NdFeB)Ni-Cu--Ni (Nickel)</p>			<div style="border: 1px solid black; padding: 2px;">                     ML1 7SL MLR                 </div>
STEEL MOUNTING PLATE	SPECIFICATIONS	CAT. NO.	ELL- AC-	MAG - PLT
	<p>Dimensions: 2" x 0.355" x 0.036" [50.8mm x 9.01mm x 0.91mm]</p> <p>Material: Steel</p>			<p>● <b>Description:</b> Steel Mounting Plate enables magnetic mounting of 4SL, 7SL, 8SL, 8CL, 9SL, LightRun or Mini LightRun fixtures on non-ferrous surfaces. Use one per magnet.</p>
BUSHING -1R	SPECIFICATIONS	CAT. NO.	ELL - AC - 1RL - BU -	
	<p>Dimensions: 1.50" x 1.00" [38.10mm x 25.40mm]</p> <p>Material: Machined 6061 Aluminum</p> <p>Finish: Silver (AL), Black (BL) Anodized; Bronze (BZ) or White (WH) Powder</p> <p>Cutout ∅ Coated 13/16" [21mm]</p>			<div style="border: 1px solid black; padding: 2px;">                     AL BL BZ WH                 </div>
BUSHING - 2RL	SPECIFICATIONS	CAT. NO.	ELL - AC - 2RL - BU -	
	<p>Dimensions: 1.50" x 1.13" [38.10mm x 28.58mm]</p> <p>Material: Machined 6061 Aluminum</p> <p>Finish: Silver (AL), Black (BL) Anodized; Bronze (BZ) or White (WH) Powder</p> <p>Cutout ∅: Coated 15/16" [24mm]</p>			<div style="border: 1px solid black; padding: 2px;">                     AL BL BZ WH                 </div>

INSIDE MOUNT END CAP - 1R

SPECIFICATIONS

CAT. NO. ELL - AC - 1R - IM -



Dimensions: 0.50" x 0.69" [12.70mm x 17.44mm]  
 Material: Machined 6061 Aluminum  
 Finish: Silver (AL), Black (BL) Anodized;  
 Bronze (BZ) or White (WH) Powder  
 Coated

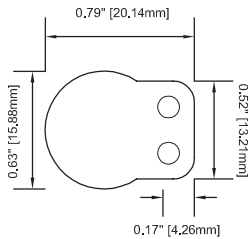
● **Description:** Inside Mount End Cap for mounting small (1R) round extrusion to insides of cabinetry (using #4 screws, provided). Factory installed – must be specified on product configurator (page 30). Requires 2 per fixture with 48" [1279.2mm] max span between. Tab extends 0.19" [4.74mm] beyond fixture diameter. Silver (AL), Black (BL), Bronze (BZ) or White (WH) finish to match fixture.

AL  
BL  
BZ  
WH

INSIDE MOUNT END CAP - 2RL

SPECIFICATIONS

CAT. NO. ELL - AC - 2RL - IM -



Dimensions: 0.63" x 0.79" [15.88mm x 20.14mm]  
 Material: 6061 Aluminum  
 Finish: Silver (AL), Black (BL) Anodized;  
 Bronze (BZ) or White (WH) Powder  
 Coated

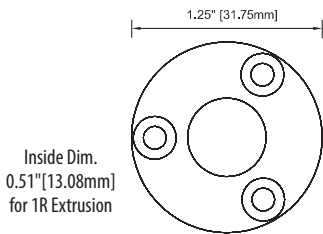
● **Description:** Inside Mount End Cap for mounting medium (2RL) round extrusion to insides of cabinetry (using #4 screws, provided). Factory installed – must be specified on product configurator (page 31). Requires 2 per fixture with 48" [1279.2mm] max span between. Tab extends 0.17" [4.26mm] beyond fixture diameter. Silver (AL), Black (BL), Bronze (BZ) or White (WH) finish to match fixture.

AL  
BL  
BZ  
WH

ADJUSTABLE INSIDE MOUNT RING - 1R

SPECIFICATIONS

CAT. NO. ELL - AC - 1R - IMR -



Dimensions: 1.25" [31.75mm]  
 Material: 6061 Aluminum  
 Thickness: 0.19" [4.83mm]  
 Finish: Silver (AL), Black (BL) Anodized;  
 Bronze (BZ) or White (WH) Powder  
 Coated

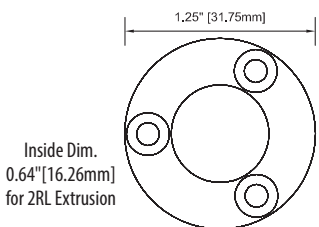
**Description:** Adjustable Inside Mount Ring for mounting small (1R) round extrusion to insides of cabinetry (using #6 FH screws, provided). Allows 60° rotation. Requires 2 per fixture with 48" [1279.2mm] max span between. 1.25" [31.75mm] diameter. Silver (AL), Black (BL), Bronze (BZ) or White (WH) finish to match fixture.

AL  
BL  
BZ  
WH

ADJUSTABLE INSIDE MOUNT RING - 2RL

SPECIFICATIONS

CAT. NO. ELL - AC - 2RL - IMR -



Dimensions: 1.25" [31.75mm]  
 Material: 6061 Aluminum  
 Thickness: 0.19" [4.83mm]  
 Finish: Silver (AL), Black (BL) Anodized;  
 Bronze (BZ) or White (WH) Powder  
 Coated

**Description:** Adjustable Inside Mount Ring for mounting medium (2RL) round extrusion to insides of cabinetry (using #6 FH screws, provided). Allows 60° rotation. Requires 2 per fixture with 48" [1279.2mm] max span between. 1.25" [31.75mm] diameter. Silver (AL), Black (BL), Bronze (BZ) or White (WH) finish to match fixture.

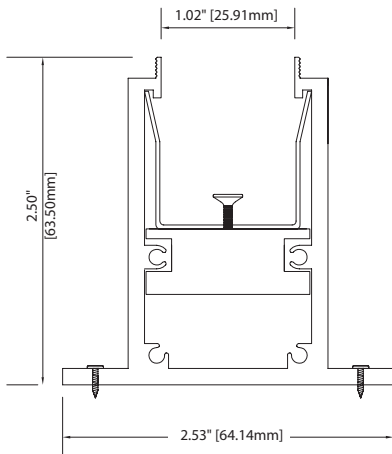
AL  
BL  
BZ  
WH

## SPECIAL MOUNTING OPTIONS 4SL & 9SL

### 9SL WALL/CEILING ROUGH-IN KIT

### SPECIFICATIONS

CAT. NO. ELL - AC - 9SL - WCR - AL



Dimensions: 2.50" x 2.53" [63.50mm x 64.14mm]  
 Material: Anodized Aluminum  
 Weight: 1.47 lbs/ft [2.18 kg/m]

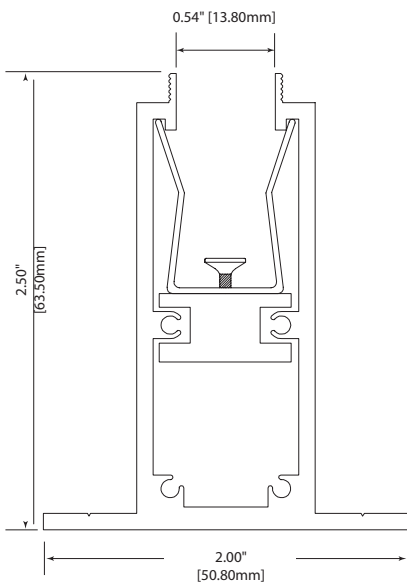
**Description:** : Rough-in extrusion for mounting large (9SL) square extrusion in wall or ceiling applications. Specify length to match fixture length. 8-32 flat head screw allows height adjustment of fixture within rough-in for an installation flush to the finished wall or ceiling surface. Rough-in includes all necessary fixture mounting clips.

(Note: System is not currently rated for use in walk-over or drive-over applications)

### 4SL WALL/CEILING ROUGH-IN KIT

### SPECIFICATIONS

CAT. NO. ELL - AC - 4SL - WCR - AL



Dimensions: 2.50" x 2.00" [63.50mm x 50.80mm]  
 Material: Anodized Aluminum  
 Weight: 1.03 lbs/ft [1.53 kg/m]

**Description:** Rough-in extrusion for mounting extra depth (4SL) square extrusion in wall or ceiling applications. Specify length to match fixture length. 8-32 flat head screw allows height adjustment of fixture within rough-in for an installation flush to the finished wall or ceiling surface. Rough-in includes all necessary fixture mounting clips.

(Note: System is not currently rated for use in walk-over or drive-over applications)



Direct-view applications using 9SL fixtures with Opal 3 lensing

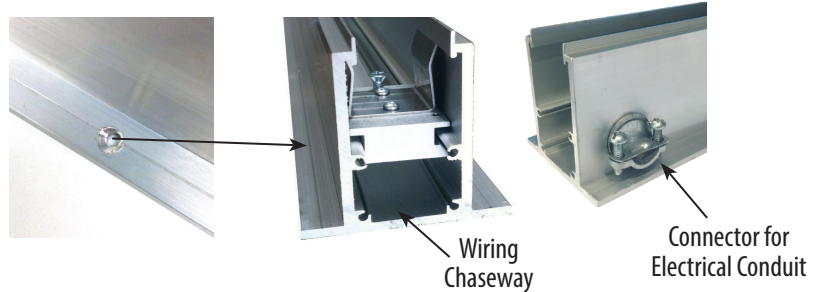
## SPECIAL MOUNTING OPTIONS 4SL &amp; 9SL

**Wall/Ceiling Rough-in Kits** enable clean, flush installation of 4SL & 9SL extrusions into wall and ceiling surfaces, primarily for use with typical drywall surfaces and stud wall construction. Rough-in Kit is recommended for use in "direct view" applications where Opal lensing fully diffuses the LEDs and creates a solid "line of light". Not suitable for floor or ground installation. The diagrams and photos below provide a brief overview of how Wall/Ceiling Rough-in Kits are installed.

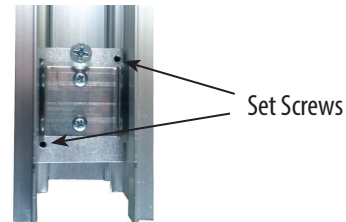
**1. Drill Extrusion:**

Drill mounting holes along each side of the extrusion approximately every 16" to 24", or to conform to the structural elements in your application.

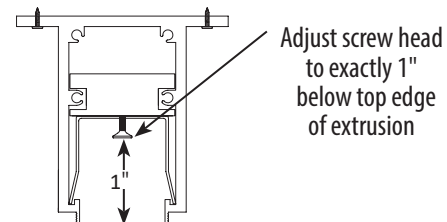
For **plenum installations**, wiring chaseway area of extrusion can be drilled into for connection of electrical conduit.

**2. Position Mounting Clip Assemblies:**

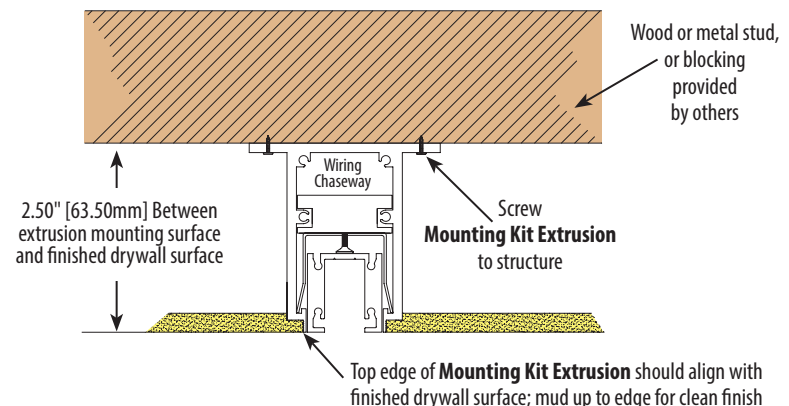
The Mounting Clip Assemblies hold the fixtures in place and should be spaced 16" on center, with a minimum 2 per fixture. Use set screws to lock clip assemblies in position.

**3. Set Fixture Height:**

The #8 flat head Phillips screw in each Mounting Clip Assembly sets the depth of the fixture in the mounting extrusion. The head of each screw should be adjusted to exactly 1" below top edge of extrusion.

**4. Install Mounting Kit Extrusion:**

Attach mounting extrusion to structural stud or blocking. Extrusion is designed for drywall to be "mudded up" to the extrusion edge, for a clean, flush finished installation.

**5. Install Fixtures:**

Insert fixtures in mounting clip assemblies; run wiring behind fixture in chaseway provided. If desired, slight gap between fixture and extrusion can be sealed using clear silicone sealant.

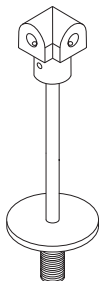


## SPECIAL MOUNTING OPTIONS - 8MM UPRIGHT (1R, 2RL & 3RL)

Display Case Applications: 1R and 2RL fixtures can be combined with 8mm End-Mount, T-Mount or Corner Mount Upright Legs to create a highly-customized display fixture system.

● Options marked by orange dots are factory-installed and must be specified on product configurator.


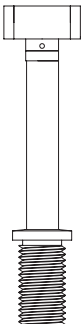

8MM END MOUNT LEG		SPECIFICATIONS	CAT. NO.	ELL - AC -	- EM8 -												
1R, 2RL	3RL	<p>Dimensions: 8mm leg ; 0.63" (15.88mm) diameter extrusion</p> <p>Material: Anodized Aluminum</p> <p>Weight: Variable</p> <p>Finish: Silver (AL), Black (BL), Bronze (BZ) Anodized; or White (WH) Powder Coated</p>			<table border="1"> <tr><td>1R</td><td>6</td><td>AL</td></tr> <tr><td>2RL</td><td>12</td><td>BL</td></tr> <tr><td>3RL</td><td>18</td><td>BZ</td></tr> <tr><td></td><td></td><td>WH</td></tr> </table>	1R	6	AL	2RL	12	BL	3RL	18	BZ			WH
1R	6	AL															
2RL	12	BL															
3RL	18	BZ															
		WH															
<p>● <b>Description:</b> End Mount Leg for 1R or 2RL round extrusion. Factory Installed – must be specified on product configurator. End Mount Leg includes Ø8mm upright, threaded bushing with hardware and cover plate. Legs are adjustable and field cuttable to achieve fixture height of 1" to 18" [25.4mm to 457.2mm]. Max recommended span between uprights is 48" [1279.2mm]. Silver (AL), Black (BL), Bronze (BZ) or White (WH) finish to match fixture. Cutout Ø 3/4" [19mm].</p>																	
8MM T-MOUNT LEG		SPECIFICATIONS	CAT. NO.	ELL - AC -	- TM8 -												
1R, 2RL	3RL	<p>Dimensions: 8mm leg; 0.63" (15.88mm) diameter extrusion</p> <p>Material: Anodized Aluminum</p> <p>Weight: Variable</p> <p>Finish: Silver (AL), Black (BL), Bronze (BZ) Anodized; or White (WH) Powder Coated</p>			<table border="1"> <tr><td>1R</td><td>6</td><td>AL</td></tr> <tr><td>2RL</td><td>12</td><td>BL</td></tr> <tr><td>3RL</td><td>18</td><td>BZ</td></tr> <tr><td></td><td></td><td>WH</td></tr> </table>	1R	6	AL	2RL	12	BL	3RL	18	BZ			WH
1R	6	AL															
2RL	12	BL															
3RL	18	BZ															
		WH															
<p>● <b>Description:</b> T-Mount Leg for connecting two 1R or 2RL round extrusions in a straight line. Multiple T-Mount Legs can be used to create extended display case fixturing. Factory Installed – must be specified on product configurator. T-Mount Leg includes Ø8mm upright, threaded bushing with hardware and cover plate. Legs are adjustable and field cuttable to achieve fixture height of 1" to 18" [25.4mm to 457.2mm]. Max recommended span between uprights is 48" [1279.2mm]. Silver (AL), Black (BL), Bronze (BZ) or White (WH) finish to match fixture. Cutout Ø 3/4" [19mm].</p>																	
8MM CORNER MOUNT LEG		SPECIFICATIONS	CAT. NO.	ELL - AC -	- CM8 -												
		<p>Dimensions: 8mm leg; 0.63" (15.88mm) diameter extrusion</p> <p>Material: Anodized Aluminum</p> <p>Weight: Variable</p> <p>Finish: Silver (AL), Black (BL), Bronze (BZ) Anodized; or White (WH) Powder Coated</p>			<table border="1"> <tr><td>1R</td><td>6</td><td>AL</td></tr> <tr><td>2RL</td><td>12</td><td>BL</td></tr> <tr><td></td><td>18</td><td>BZ</td></tr> <tr><td></td><td></td><td>WH</td></tr> </table>	1R	6	AL	2RL	12	BL		18	BZ			WH
1R	6	AL															
2RL	12	BL															
	18	BZ															
		WH															
<p>● <b>Description:</b> : Corner Mount Leg for connecting two 1R or 2RL round extrusions at a 90° angle. Multiple Corner Mount Legs can be used to create extended display case fixturing in unique shapes. Factory Installed – must be specified on product configurator. Corner Mount Leg includes Ø8mm upright, threaded bushing with hardware and cover plate. Legs are adjustable and field cuttable to achieve fixture height of 1" to 18" [25.4mm to 457.2mm]. Max recommended span between uprights is 48" [1279.2mm]. Silver (AL), Black (BL), Bronze (BZ) or White (WH) finish to match fixture. Cutout Ø 3/4" [19mm].</p>																	



SPECIAL MOUNTING OPTIONS - 16MM UPRIGHT (2RL ONLY)

2RL fixtures can be combined with 16mm End-Mount, T-Mount or Corner Mount Upright Legs to create a highly-customized display fixture system. 16mm Upright Legs will provide a continuous .63" [15.9mm] leg to match the diameter of the 2RL fixture. 16mm Upright Legs can be composed of empty or illuminated segments. See diagrams and details on page 51 for more information. Contact factory for more information on specifying illuminated leg segments.

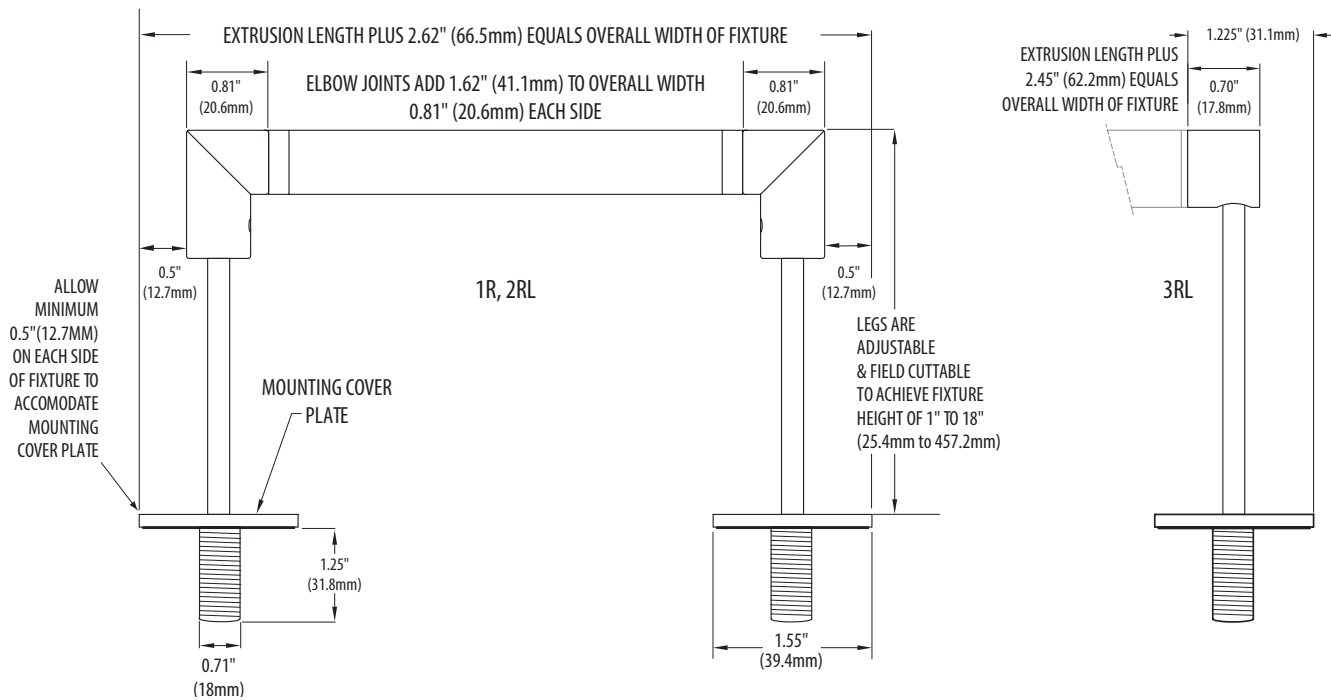
● Options marked by orange dots are factory-installed and must be specified on product configurator.

16MM END MOUNT LEG	SPECIFICATIONS	CAT. NO.	ELL - AC - 2RL - EM16 -		
	<p>Dimensions: 0.63" (15.9mm) diameter extrusion leg</p> <p>Material: Anodized Aluminum</p> <p>Weight: Variable</p> <p>Finish: Silver (AL), Black (BL) Anodized; Bronze (BZ) or White (WH) Powder Coated</p>	<p>● <b>Description:</b> 16mm End Mount Leg/Connector for 2RL extrusion. Leg segments may be configured with empty or illuminated extrusion (Factory Installed – must be specified on product configurator. 16mm End Mount Leg includes 6", 12" or 18" upright and threaded bushing. Empty legs are adjustable and field cuttable to achieve fixture height of 1" to 18" [25.4mm to 457.2mm]. Illuminated legs are adjustable but NOT field cuttable. Max recommended span between uprights is 48" [1279.2mm] Silver (AL), Black (BL), Bronze (BZ) or White (WH) finish to match fixture. Cutout <math>\varnothing</math> 15/16" [24mm].</p>	6	AL	
			12	BL	
			18	BZ	
				WH	
16MM T-MOUNT LEG	SPECIFICATIONS	CAT. NO.	ELL - AC - 2RL - TM16 -		
	<p>Dimensions: 0.63" (15.9mm) diameter extrusion</p> <p>Material: Anodized Aluminum</p> <p>Weight: Variable</p> <p>Finish: Silver (AL), Black (BL) Anodized; Bronze (BZ) or White (WH) Powder Coated</p>	<p>● <b>Description:</b> 16mm T Mount Leg/Connector for 2RL extrusion. Leg segments may be configured with empty or illuminated extrusion (Factory Installed – must be specified on product configurator. 16mm T Mount Leg includes 6", 12" or 18" upright and threaded bushing. Empty legs are adjustable and field cuttable to achieve fixture height of 1" to 18" [25.4mm to 457.2mm]. Illuminated legs are adjustable but NOT field cuttable. Max recommended span between uprights is 48" [1279.2mm] Silver (AL), Black (BL), Bronze (BZ) or White (WH) finish to match fixture. Cutout <math>\varnothing</math> 15/16" [24mm].</p>	6	AL	
			12	BL	
			18	BZ	
				WH	
16MM CORNER MOUNT LEG	SPECIFICATIONS	CAT. NO.	ELL - AC - 2RL - CM16 -		
	<p>Dimensions: 0.63" (15.9mm) diameter extrusion</p> <p>Material: Anodized Aluminum</p> <p>Weight: Variable</p> <p>Finish: Silver (AL), Black (BL) Anodized; Bronze (BZ) or White (WH) Powder Coated</p>	<p>● <b>Description:</b> 16mm Corner Mount Leg/Connector for 2RL extrusion. Leg segments may be configured with empty or illuminated extrusion (Factory Installed – must be specified on product configurator. 16mm Corner Mount Leg includes 6", 12" or 18" upright and threaded bushing. Empty legs are adjustable and field cuttable to achieve fixture height of 1" to 18" [25.4mm to 457.2mm]. Illuminated legs are adjustable but NOT field cuttable. Max recommended span between uprights is 48" [1279.2mm] Silver (AL), Black (BL), Bronze (BZ) or White (WH) finish to match fixture. Cutout <math>\varnothing</math> 15/16" [24mm].</p>	6	AL	
			12	BL	
			18	BZ	
				WH	

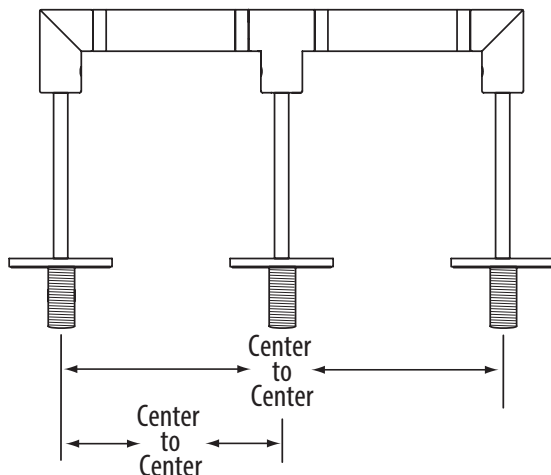


## SPECIAL MOUNTING OPTIONS - 8MM UPRIGHTS

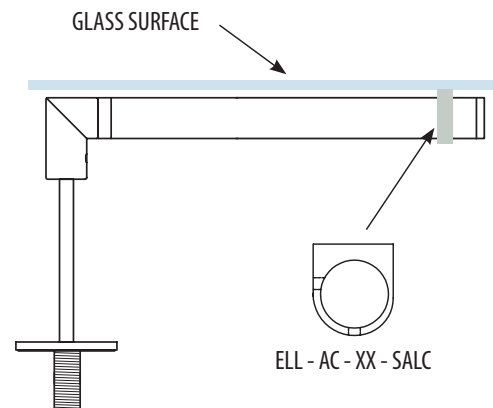
(Fig. A) below details the dimensions to be considered when designing a basic two-legged fixture using 8mm Upright Legs. For more complex configurations that include T-Mount and Corner Mount Leg components (Fig. B) please visit the website and download the "8mm Free-Standing Display Worksheet" on the 1R or 2RL Downloads tab. Glass showcases can also be configured using a single leg support combined with Self-Adhesive Locking Clips (page 41) which adhere directly to the glass surface (Fig. C).



**Fig. B:** For laying out fixture configurations with three or more legs, please use the "8mm Free-Standing Display Worksheet" which can be found online on the 1R or 2RL Downloads tab.

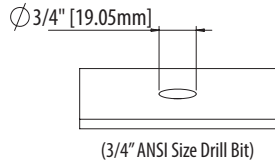


**Fig. C:** Single-legged configurations can be attached to glass surfaces using Self-Adhesive Locking Clip (pg. 41). One clip every 12"-16".

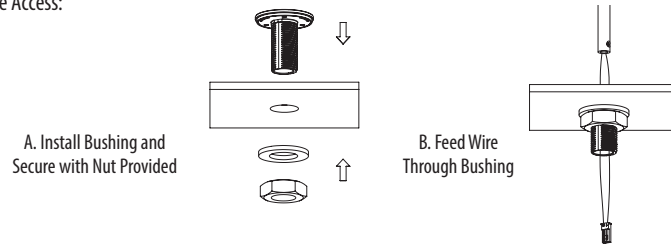




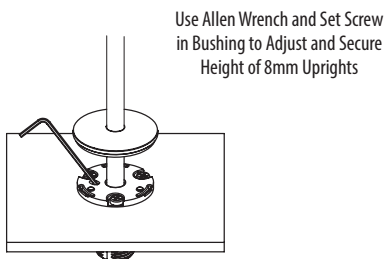
Cutout Dimension for 8mm Bushings



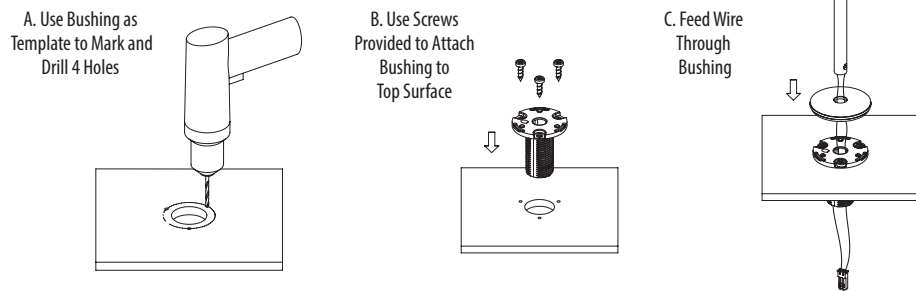
1. Installation with Underside Access:



Height Adjustment



2. Installation with Topside Access Only

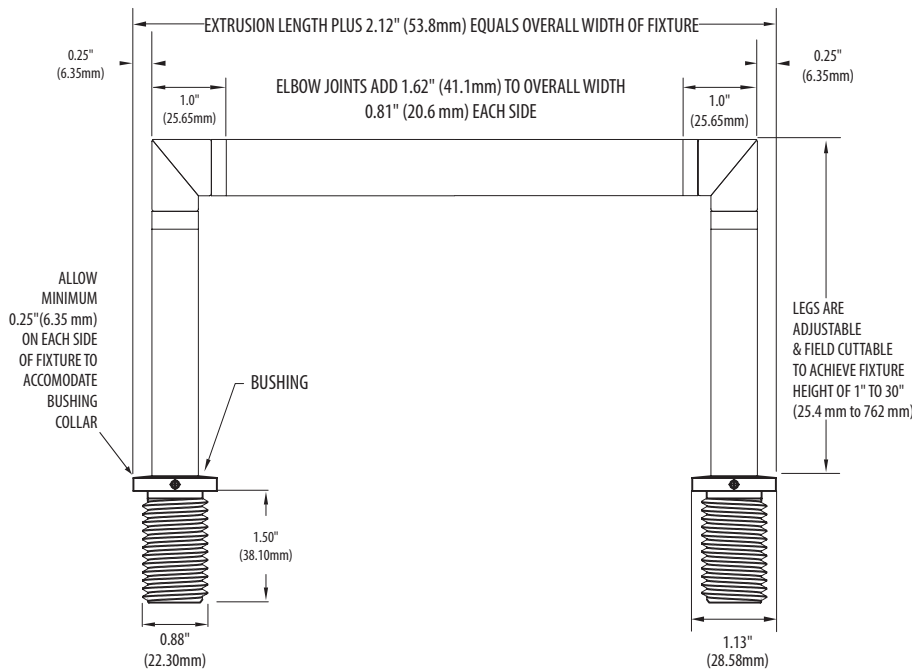


Combine **1R** and **2RL** fixtures with 8mm End Mount, T-Mount or Corner Mount Legs to create unlimited custom display configurations.

## SPECIAL MOUNTING OPTIONS - 16MM UPRIGHTS (2RL ONLY)

2RL fixtures can be configured with 16mm End Mount, T-Mount or Corner Mount Upright Legs to provide a continuous .63" [15.88mm] leg to match the diameter of the 2RL fixture. Upright Legs can be composed of empty or illuminated fixture segments.

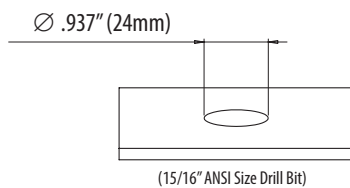
(Fig. A) below details the dimensions to be considered when designing a basic two-legged fixture using 16mm Upright Legs. For more complex configurations that include T-Mount and Corner Mount Leg components, please visit the website and download the "16mm Free-Standing Display Worksheet" on the 2RL Downloads tab.



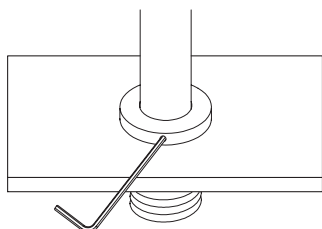
**Fig. A**  
Typical two-legged configuration

16mm legs can be configured using *empty extrusion* that matches the diameter and finish of the 2RL fixture, or can be configured using *illuminated segments* (contact VLT factory for more information); empty and illuminated legs are adjustable to achieve fixture height of 1" to 18"; *empty extrusion* is field cuttable

### Cutout Dimension for 16mm Bushing



### Height Adjustment



Use Allen Wrench and Set Screw in Bushing Collar to Adjust and Secure Height of 16mm Uprights



2RL fixture with 16mm illuminated legs.

## FLEXIBLE



Our EFlex and EFlexW LED tape products have been reinvented to provide more lumen options and new DIY possibilities! Lumen outputs range from 222 lm/ft. to 590 lm/ft, and the 95 CRI ensures an installation that is both easy and beautiful. EFlex now offers 6 mounting extrusions, making it easy for anyone to create and install custom accent fixtures on site. EFlexW lengths are custom-cut and sheathed in silicone to provide beautiful accent lighting in wet or damp environments.



## EFLEX INTERIOR FLEXIBLE FUNDAMENTALS

All LEDs binned to 2 MacAdam Ellipse CCT tolerance of  $\pm 60^\circ$

EFlex available in **2700K, 3000K, 3500K, 4000K & 4500K**

LED Board	1320	2320	4320
LUMEN OUTPUT*	222 lm/ft [728 lm/m]	335 lm/ft [1098lm/m]	590 lm/ft [1,935 lm/m]
POWER CONSUMPTION	2.0 w/ft. [6.6 w/m]	2.8 w/ft [9.2 w/m]	5.9 w/ft [19.4 w/m]
COUPON LENGTH	3.28" [83.3mm]	3.28" [83.3mm]	3.28" [83.3mm]
CRI	95	95	95
CCT OPTIONS	ALL	ALL	ALL
APPLIED LED	Nichia 3030 SMD	Nichia 3030 SMD	Nichia 3030 SMD
LED EFFICACY*	111 lm/w	119 lm/w	100 lm/w

All photometrics based on 3500K CCT

LENSING	None
FINISH	White silk screen
LENGTHS	0.393" [10.0mm] wide x 0.046" [1.17mm] high x 16.4' [4998mm]; field cuttable in 3.28" [83.3mm] coupons. Maximum Continuous Length: 1320: 36' [11m], 2320: 26' [8m], 4320: 16.4' [5m]
ELECTRICAL	<b>Driver Type:</b> Constant Voltage, Class 2 UL Listed <b>Input Voltage:</b> 24v DC <b>Dimming:</b> MLV, ELV, 0-10V, DALI, DMX <b>Feed Wire:</b> 12" [305mm] Lead of 20 AWG Wire [1.02mm <sup>2</sup> ] Bare Wire <b>Operating Ambient Temperature:</b> -22° to 104° F [-30° to 40° C] <div style="float: right; border: 1px solid black; padding: 2px;">CV</div>
LIFE & WARRANTY	50,000 HR lifetime ( $T_a = -20^\circ\text{C}$ to $60^\circ\text{C}$ ; $T_c$ max $67^\circ\text{C}$ ); 5 year limited warranty
MOUNTING	3M VHB Tape, provided
LISTINGS & TESTS	 (UL 2108 & 8750);  RoHS Compliant (if specified); LM79, LM80; IP20, Dry Location Only For UL Listed application within the closet storage space, use 1320 LED Board Only <small>The EU's Restriction of Hazardous Substances Directive (RoHS) restricts the use of six hazardous substances* in electrical and electronic equipment (* Lead (Pb), Mercury, Cadmium, Hexavalent chromium, Polybrominated biphenyls and Polybrominated diphenyl ether (PBDE)).</small>

**EFlex Flexible LEDs** put all the great light quality of EssentialLEDs® into a budget-friendly bendable format that's perfect for curved surfaces like coves and columns. EFlex can install directly onto the mounting surface using the adhesive backing, or can be combined with five different field-cuttable extrusions to create DIY fixtures on site.

- Under Counters & Toe Kicks
- Accents for Coves & Niches
- Uplights Above Cabinetry
- Halo Effects for Headboards, Mirrors & Entertainment Centers

Five color temperatures with lumen output ranging from 222 lm/ft. to 590 lm/ft. Can be purchased by the 16.4 ft. [5000mm] spool; can be cut in the field every 3.28" [83.3mm]. 95 CRI.

EFlex is dimmable using MLV, ELV, 0-10v, DALI or DMX. Visit the VLT website for application photos and the most recent information.

CCT	2700K	3000K	3500K	4000K	4500K
LIGHT OUTPUT CONVERSION	.96	1.0	1.0	1.0	1.01

VLT reserves the right to change specifications without notice. Please visit [www.vltcorp.com](http://www.vltcorp.com) for current cut sheets.

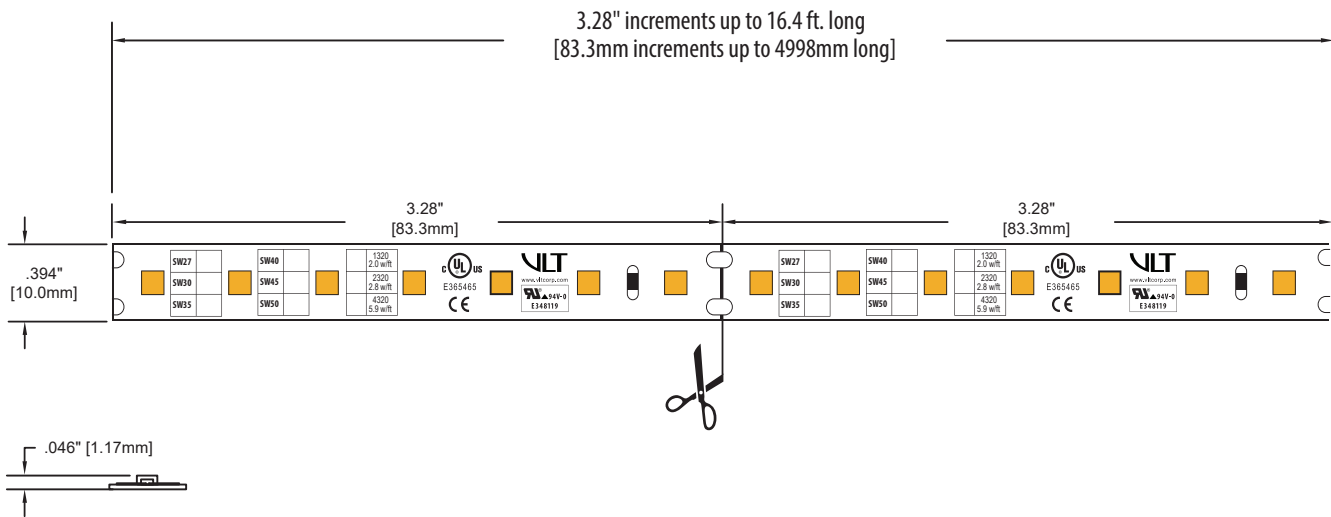
EFLEX FLEXIBLE LEDs - INTERIOR

IP20 | Flexible LED strip for interior linear lighting applications. Dry location. Includes Nichia LEDs in choice of 3 lumen/wattage levels on a flexible, self-adhesive substrate; all LEDs binned to within 2 MacAdam ellipse CCT tolerance of  $\pm 60^\circ\text{K}$ . Standard color temperatures of 2700K, 3000K, 3500K, 4000K and 4500K. Available as a field-cuttable spool of 16.4 ft [5000mm].



LED		CCT		Lens Options		Wire Exit		Listings	
1320	222 lm/ft, 2.0 w/ft, 95 CRI	27	2700°K	NL	No Lens	WE1	Default	UL	UL Listed
2320	335 lm/ft, 2.8 w/ft, 95 CRI	30	3000°K					CE	CE Listed (RoHS)
4320	590 lm/ft, 5.9 w/ft, 95 CRI	35	3500°K						
		40	4000°K						
		45	4500°K						

Strip Length  
4998mm Spool







## EFLEXW EXTERIOR FLEXIBLE FUNDAMENTALS

All LEDs binned to an overall 2 MacAdam ellipse CCT tolerance of  $\pm 60^\circ$ .  
LED Board available in **2700K, 3000K, 3500K, 4000K & 4500K**

LED Board	1320	2320	4320
LUMEN OUTPUT	222 lm/ft [728lm/m]	335 lm/ft [1098 lm/m]	590 lm/ft [1,935 lm/m]
POWER CONSUMPTION	2.0 w/ft. [6.6 w/m]	2.8 w/ft [9.2 w/m]	5.9 w/ft [19.4 w/m]
COUPON LENGTH	3.28" [83.3mm]	3.28" [83.3mm]	3.28" [83.3mm]
CRI	95	95	95
CCT OPTIONS	ALL	ALL	ALL
APPLIED LED	Nichia 3030 SMD	Nichia 3030 SMD	Nichia 3030 SMD
LED EFFICACY*	111 lm/w	119 lm/w	100 lm/w

All photometrics based on 3500K CCT

LENSING	Silicone sheathing
FINISH	White silk screen
LENGTHS	0.393" [10.0mm] wide x 0.050" [1.25mm] high and up to 16.4' [4998mm]; field cuttable in 3.28" [83.3mm] coupons
ELECTRICAL	<p><b>Driver Type:</b> Constant Voltage, Class 2 UL Listed</p> <p><b>Input Voltage:</b> 24v DC</p> <p><b>Dimming:</b> MLV, ELV, 0-10V, DALI, DMX</p> <p><b>Feed Wire:</b> Pre-cut lengths: 96" [2.44m] of 20 AWG Wire [1.02mm<sup>2</sup>] with Male Connector</p> <p><b>Operating Ambient Temperature:</b> -22° to 104° F [-30° to 40° C]</p>
LIFE & WARRANTY	50,000 HR lifetime ( $T_a = -20^\circ\text{C}$ to $60^\circ\text{C}$ ; $T_c$ max $75^\circ\text{C}$ ); 5 year limited warranty
MOUNTING	Silicone brackets, screwed
LISTINGS & TESTS	<p> (UL 2108 &amp; 8750);  RoHS Compliant (if specified); LM79, LM80 ; IP20</p> <p>For UL Listed application within the closet storage space, use 1320 LED Board Only</p> <p>The EU's Restriction of Hazardous Substances Directive (RoHS) restricts the use of six hazardous substances* in electrical and electronic equipment (* Lead (Pb), Mercury, Cadmium, Hexavalent chromium, Polybrominated biphenyls and Polybrominated diphenyl ether (PBDE)).</p>

The addition of silicone sheathing transforms our flexible LED tape into a water resistant (IP65) product to add beautiful linear lighting to damp or wet environments. Flexible **EFlexW** is the ideal product for curved surfaces, but also provides a budget-friendly solution for outdoor lighting on straight surfaces. EFlexW provides beautiful accents in three brightness levels and six CCTs for locations such as:

- Curved Sit Walls & Planters
- Patios and Outdoor Kitchens
- Water Features (non-submersible)
- Damp/Wet Interior Locations Like Bars & Food Prep Areas

EFlexW comes in sheathed and wired pieces that are multiples of the 3.28" [83.3mm] coupon plus endcaps, up to a maximum length of 16.4 feet [5000mm]. Pieces mount using soft brackets that straddle the tape and screw into the mounting surface (one per 12"). EFlexW is dimmable using MLV, ELV, 0-10v, DALI or DMX. Visit the VLT website for application photos and the most recent information.



CCT	2700K	3000K	3500K	4000K	4500K
LIGHT OUTPUT CONVERSION	.96	1.0	1.0	1.0	1.01

VLT reserves the right to change specifications without notice. Please visit [www.vltcorp.com](http://www.vltcorp.com) for current cut sheets.

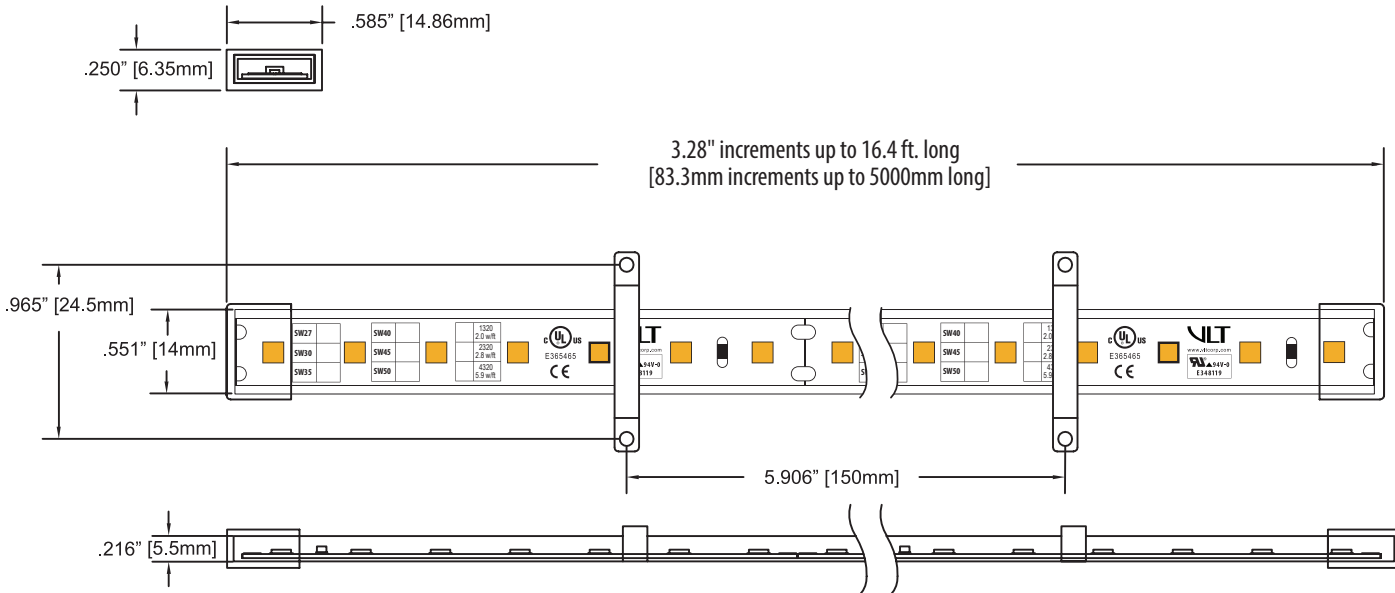
EFLEXW FLEXIBLE LEDS - EXTERIOR



IP65 | Flexible LED strip for exterior and wet location linear lighting applications. Includes Nichia LEDs in choice of 3 lumen/wattage levels on a flexible substrate, sealed into a weatherproof silicone sheathing; all LEDs binned to within 2 MacAdam ellipse CCT tolerance of ±60°K. Standard color temperatures of 2700K, 3000K, 3500K, 4000K and 4500K. Specify pre-cut "coupon" length in 3.28" [83.3mm] segments up to 16.4 ft [5000mm]. End caps add .045" [1.14mm] to each end of LED strip length. Mount with screwed silicone brackets on 12" centers. See below for bracket information.

LED		CCT		Lens Options		Wire Exit		Listings	
1320	222 lm/ft, 2.0 w/ft, 95 CRI	27	2700°K	NL	No Lens	WE1	Default	UL	UL Listed
2320	335 lm/ft, 2.8 w/ft, 95 CRI	30	3000°K					CE	CE Listed (RoHS)
4320	590 lm/ft, 5.9 w/ft, 95 CRI	35	3500°K						
		40	4000°K						
		45	4500°K						

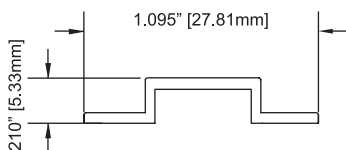
**Strip Length**  
3.44" increments up to 16.4' long  
[87.5mm increments up to 5000mm long]



SOFT BRACKET

SPECIFICATIONS

CAT. NO. ELL-AC - EFLEXW - SB



Dimensions: 1.095" [27.81mm] x 0.210" [5.33mm]

Material: Silicone

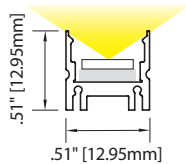
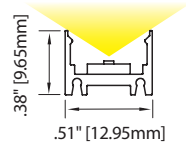
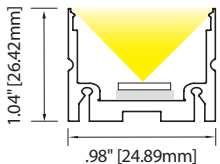
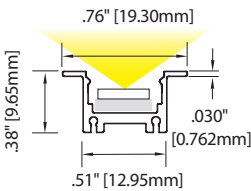
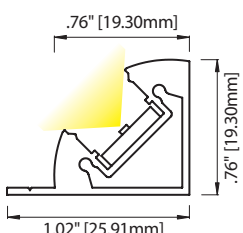
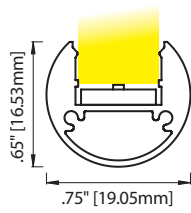
**Description:** Silicone bracket straddles sheathed EFLEXW strip; screws to mounting surface on each end (screws provided by others). Recommended spacing: every 12".



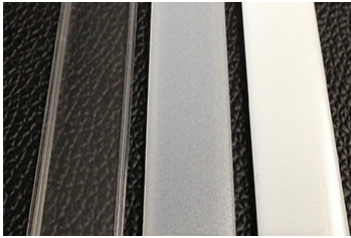


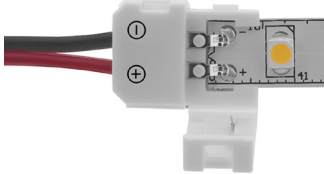
## EFLX INTERIOR FLEXIBLE ACCESSORIES


**New!** IP20 | Our EFlex Accessories allow you to build DIY LED fixtures on site with your choice of six different extrusion profiles. Extrusion and lensing can be purchased in 6 ft [1.83 m] lengths to be cut as needed; add end caps for easy custom-length fixtures with outstanding light quality; all LEDs binned to within 2 MacAdam ellipse CCT, 95+ CRI.


PROFILE	SPECIFICATIONS	CAT. NO.	
<b>PROFILE 8SL</b> 	Dimensions: 0.51" x 0.51" x 6 ft [12.95mm x 12.95mm x 1.83m] Material: Aluminum Finish: Silver (AL) or Black (BL)	EFX - AC - 8SL - 6FT -	AL BL
<b>PROFILE 8CL</b> 	Dimensions: 0.51" x 0.38" x 6 ft [12.95mm x 9.65mm x 1.83m] Material: Aluminum Finish: Silver (AL) or Black (BL)	EFX - AC - 8CL - 6FT -	AL BL
<b>PROFILE 9SL</b> 	Dimensions: 0.98" x 1.04" x 6 ft [24.89mm x 26.42mm x 1.83m] Material: Aluminum Finish: Silver (AL) or Black (BL)	EFX - AC - 9SL - 6FT -	AL BL
<b>PROFILE 8FL</b> 	Dimensions: 0.76" x 0.38" x 6 ft [19.30mm x 9.65mm x 1.83m] Material: Aluminum Finish: Silver (AL) or Black (BL)	EFX - AC - 8FL - 6FT -	AL BL
<b>PROFILE 2QL</b> 	Dimensions: 1.02" x 0.76" x 6 ft [25.91mm x 19.30mm x 1.83m] Material: Aluminum Finish: Silver (AL) or Black (BL)	EFX - AC - 2QL - 6FT -	AL BL
<b>PROFILE 3RL</b> 	Dimensions: 0.75" x 0.65" x 6 ft [19.05mm x 16.53mm x 1.83m] Material: Aluminum Finish: Silver (AL) or Black (BL)	EFX - AC - 3RL - 6FT -	AL BL

PROFILE END CAP	SPECIFICATIONS	CAT. NO.	EFX - AC -	- EC -			
	Depth: 0.177" [4.5mm] Each Material: Aluminum Finish: Silver (AL) or Black (BL)				8SL	HL	AL
					8CL	NH	BL
					8FL		
					9SL		
					2QL		
					3RL		
					<b>Description:</b> Aluminum End Cap for Profile extrusion. With Hole (HL) for wire exit end, Without Hole (NH) for non-wired end; one of each required to complete DIY fixture.		

LENSING	SPECIFICATIONS	CAT. NO.	EFX - AC - LENS -		
	Length: 6 ft [1.83m] Material: Acrylic Finish: Clear, Frosted or Opal			8SL	PG
				8CL	OP1
				8FL	OP2
				9SL	OP3
				2QL	
				3RL	
				<b>Description:</b> Lensing for all extrusion profiles in 6 ft [1.83m] length; cut in field to desired lengths for DIY fixtures. Lensing snaps securely into extrusion.	

STARTER CABLE/CONNECTOR	SPECIFICATIONS	CAT. NO.	EFX - AC - CV - SC
	Dimensions: 0.56" x 0.60" [15mm x 16mm], 8" [25.4mm] wire Material: Plastic		

INTERCONNECT WIRE	SPECIFICATIONS	CAT. NO.	EFX - AC - CV - ICW - 4
	Dimensions: 0.56" x 0.60" [15mm x 16mm], 4" [101.6mm] wire Material: Plastic		

INTERCONNECT CONDUCTOR	SPECIFICATIONS	CAT. NO.	EFX - AC - CV - ICC
	Dimensions: 0.56" x 0.60" [15mm x 16mm] Material: Plastic		

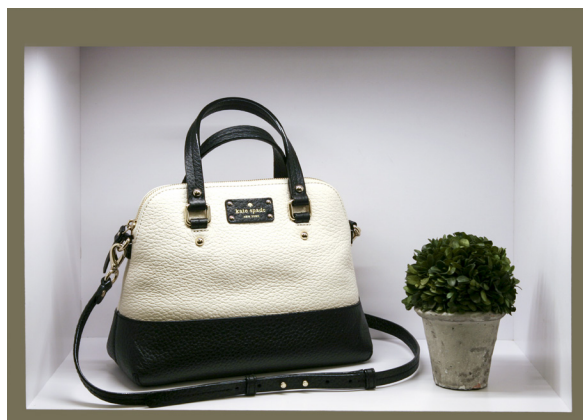
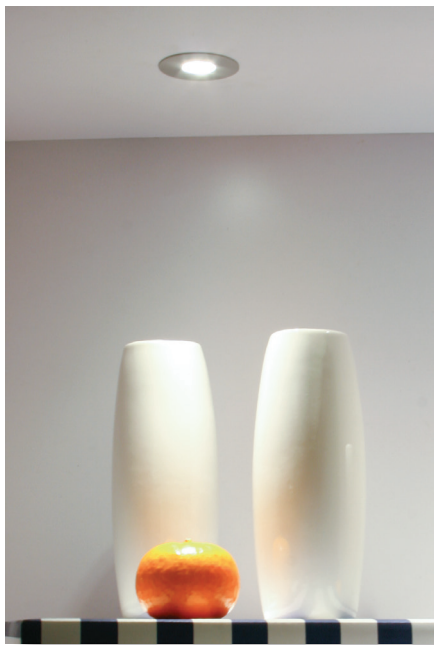
MOUNTING CLIP

Refer to Linear Mounting Accessories

Notes:

Lined area for notes, consisting of approximately 25 horizontal lines.

## SPECIALTY DISPLAY



Products: Elegance Puck, LightRun,  
Elegance Puck, Elegance Cylinder

## ELEGANCE<sup>2</sup> FUNDAMENTALS

All LEDs binned to within a 2 MacAdam ellipse CCT tolerance of ±60°. 4219C LED Board available in **2700K, 3000K, 3500K, 4000K & 4500K**.

	4219C/350mA Driver	4219H/350mA Driver
LUMEN OUTPUT	296 lm	287 lm
FIXTURE WATTAGE	4.4w	4.4w
CRI	87	95+
CCT OPTIONS	2700K, 3000K, 3500K, 4000K, 4500K	2700K, 3000K, 3500K, 4000K
APPLIED LED	Nichia 219C	Nichia 219C
LED EFFICACY*	94 lm/w	91 lm/w
FIXTURE EFFICACY* <small>not including driver losses</small>	67 lm/w	65 lm/w

Beam	Lumens	Footcandles @ 12"
15°	400 lm	1741 fc
30°	353 lm	1078 fc
60°	340 lm	592 fc
30° x 60°	296 lm	459 fc

All photometrics based on 3500K CCT



The EssentialLEDs® **Elegance<sup>2</sup>** fixture was developed to provide exceptional lighting flexibility in retail display applications. Its high light output, low energy use and long lamp life make Elegance<sup>2</sup> an ideal fixture for fully illuminating small displays, or adding focused highlights to larger casework. The adjustable head has a **tilt range of +/- 65°** to accommodate changing display needs; Stem Mount 3 (ST3) option provides a **fixed 15° angle**.

Elegance<sup>2</sup> offers 15°, 30°, 60° and 30° x 60° lensing options; 30° x 60° option creates an oval light distribution that is ideal for illuminating elongated merchandise like handbags and jewelry. Elegance<sup>2</sup> heads can be stem-mounted for free-standing installation, or attached directly to the case structure in surface-mount or recessed-mount configurations.

Elegance<sup>2</sup> fixtures are dimmable and available in five color temperatures, with a CRI up to 95+. LED component can be replaced in field by trained technician.

Visit the VLT website for application photos and most recent information.

LENSING	15°, 30°, 60° and 30° x 60°
FINISH	Silver, Black, Custom finishes on request
DIMENSIONS	1.49" x 1.74" x 0.41" [37.84mm x 44.19mm x 10.41mm]
ELECTRICAL	<b>Driver Type:</b> Constant Current, 350mA, Class 2 UL Listed <b>Input Voltage:</b> 12.7v <b>Dimming:</b> 0-10V, DALI, DMX <b>Feed Wire:</b> 96" [2.44m] of 20 AWG Wire [1.02mm <sup>2</sup> ], Male Connector <b>Operating Ambient Temperature:</b> -22° to 104° F [-30° to 40° C]
LIFE & WARRANTY	50,000 HR lifetime (T <sub>a</sub> = -25°C to 35°C; T <sub>c</sub> max 75°C); 5 year limited warranty
MOUNTING	Multiple options including stems, bushings, surface mount and free standing
LISTINGS & TESTS	cULus (2108, 8750); CE RoHS Compliant (if specified); LM79, LM80; IP20, Dry Location Only The EU's Restriction of Hazardous Substances Directive (RoHS) restricts the use of six hazardous substances* in electrical and electronic equipment (* Lead (Pb), Mercury, Cadmium, Hexavalent chromium, Polybrominated biphenyls and Polybrominated diphenyl ether (PBDE)).



CCT	2700K	3000K	3500K	4000K	4500K
LIGHT OUTPUT CONVERSION	0.88	1.0	1.0	1.08	1.08

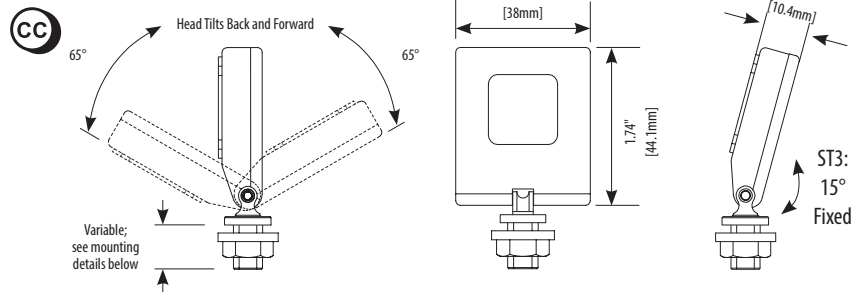
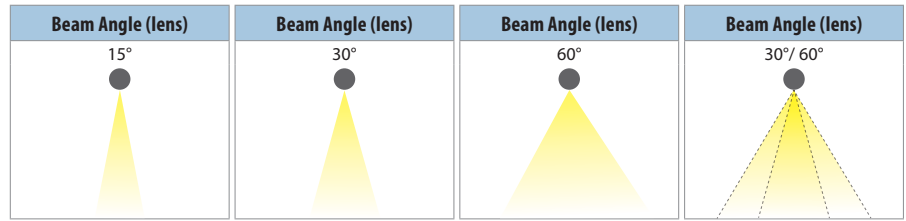




ELEGANCE<sup>2</sup>

IP20 | Compact square fixture featuring specialized Constant Current LED board and lensing for display applications. Includes Nichia LEDs with either 87 or 95+ CRI in various color temperatures. All LEDs include ±60K Micro Binning. Fixture head tilts +/- 65°, with 15°, 30°, 60° or 30° x 60° lens options. Silver, Black or Custom Finishes. Multiple mounting options available.

Photometrics vary based on CCT and CRI; see photometrics page for conversion.



ELL-EG2 -

LED		CCT		Finish		Lens Options		Wire Exit		Listings & Mounting Options	
4219C	87 CRI	27	2700°K	AL	Silver	15	15° Lens	WE1	Default	UL	UL Listed
4219H	95+ CRI <sup>1</sup>	30	3000°K	BL	Black	30	30° Lens			CE	CE Marked (RoHS)
		35	3500°K	C	Custom	60	60° Lens			ST1	Stem Mount, 0.25" [6.35mm] max, Adjustable
		40	4000°K			3060	30° x 60°			ST2	Stem Mount, 0.75" [19.05mm] max, Adjustable
		45	4500°K							ST3	Stem Mount, 0.25" [6.35mm] max, 15° Fixed Tilt
										BU	Bushing Mount
										SU	Surface Mount
										FS6	8mm Free Stand Mount 6" [152.4mm]
										FS12	8mm Free Stand Mount 12" [304.8mm]
										FS18	8mm Free Stand Mount 18" [457.2mm]

MOUNTING OPTIONS

STEM MOUNT (ST1, ST2, ST3)	BUSHING MOUNT (BU)	SURFACE MOUNT (SU)	FREE STAND MOUNT (FS6, FS12, FS18)
<p>Max 1.816" [46.12mm]</p> <p>ST1: Max 0.25" [6.35mm] Adjustable</p> <p>ST2: Max 0.75" [19.05mm] Adjustable</p> <p>ST3: Max 0.25" [6.35mm] Fixed 15° Tilt</p>	<p>Max 1.973" [50.11mm]</p> <p>1.25 in [38.1mm] Max</p> <p>0.312 in [7.93mm] Cutout</p> <p>0.8113 in [20.56mm] Cutout</p>	<p>Max 1.955" [49.65mm]</p> <p>0.312 in [7.93mm] Cutout</p>	<p>Max 19.85" [504.19mm]</p> <p>Adjustable Stem Height</p> <p>1 inch to 18 inches [25.4mm to 457.2mm]</p> <p>1.00 in [25.4mm]</p> <p>0.75 in [19.05mm] Cutout</p>
<p>Stem Mount provides most minimal mounting option; stem attaches with nut on rear side of mounting surface; no rotation. Choose ST1 or ST2 based on the thickness of mounting surface. Max thickness for ST1: 0.25" [6.35mm] Max thickness for ST2: 0.75" [19.05mm] Max thickness for ST3: 0.25" [6.35mm].</p>	<p>Bushing Mount provides the finished look of a ferrule at fixture base, allows 360° rotation of fixture head; position can be fixed with set screw. Bushing is attached with nut on rear side of mounting surface. Maximum mounting surface thickness 1.25" [38.1mm].</p>	<p>Surface Mount allows installation of fixture with screws to top surface, no rear access necessary, all mounting surface thicknesses okay. Surface Mount allows 360° rotation of fixture head; position can be fixed with set screw.</p>	<p>Free Stand Mount available in three stem height options; further height adjustment possible via set screw in fixture base. Free Stand Mount can be installed via screws from top surface, or with nut on rear side (no more than 1" mounting surface thickness recommended.) Top surface mount allow 360° rotation after installation; nut on rear side does not. See Special Mounting Options for bushing installation details.</p>

## New! ELEGANCE CYLINDER FUNDAMENTALS

All LEDs binned to within a 2 MacAdam ellipse CCT tolerance of  $\pm 60^\circ$ .

	1250/700mA Driver	1250/1050mA Driver	1250H/700mA Driver	1250H/1050mA Driver
LUMEN OUTPUT	127 lm	153 lm	123 lm	148 lm
FIXTURE WATTAGE	2.4w	3.7w	2.4w	3.7w
CRI	87	87	95+	95+
CCT OPTIONS	2700K, 3000K, 3500K, 4000K, 4500K		2700K, 3000K, 3500K, 4000K	
APPLIED LED	Nichia 219C	Nichia 219C	Nichia 219C	Nichia 219C
LED EFFICACY*	94 lm/w	94 lm/w	91 lm/w	91 lm/w
FIXTURE EFFICACY* not including driver losses	53 lm/w	41 lm/w	51 lm/w	40 lm/w

	1250/700mA Driver		1250/1050mA Driver	
Beam	Lumens	Footcandles @ 12"	Lumens	Footcandles @ 12"
Narrow	115 lm	435 fc	139 lm	495
Medium	127 lm	300 fc	153 lm	374
Wide	86 lm	139 fc	103 lm	160

All photometrics based on 3500K CCT

LENSING	Narrow, Medium or Wide Individual Reflectors, Interchangeable in Field
FINISH	Silver, Black, Custom Finishes on Request
DIMENSIONS	1.75" x $\varnothing$ 0.88" x 0.50" [44.5mm x $\varnothing$ 22.2mm x 13.2mm]
ELECTRICAL	<b>Driver Type:</b> Constant Current, 700mA or 1050mA, Class 2 UL Listed <b>Input Voltage:</b> 3.2v <b>Dimming:</b> 0-10 v, DMX, DALI (see Driver Cut Sheet) <b>Feed Wire:</b> 96" [2.44m] of 20 AWG Wire [1.02mm <sup>2</sup> ], Male Connector <b>Operating Ambient Temperature:</b> -22° to 104° F [-30° to 40° C] <b>Humidity:</b> 90% RH Non-Condensing
LIFE & WARRANTY	50,000 HR Lifetime ( $T_a = -25^\circ\text{C}$ to $35^\circ\text{C}$ ; $T_c$ max $75^\circ\text{C}$ ); 5 Year Limited Warranty
MOUNTING	Surface Mount or Free Standing
LISTINGS & TESTS	e <sub>us</sub> (2108, 8750); <b>CE</b> RoHS Compliant (if specified); LM79, LM80; IP20, Dry Location Only The EU's Restriction of Hazardous Substances Directive (RoHS) restricts the use of six hazardous substances* in electrical and electronic equipment (* Lead (Pb), Mercury, Cadmium, Hexavalent chromium, Polybrominated biphenyls and Polybrominated diphenyl ether (PBDE)).

Elegance Cylinder adds a new shape to our Specialty Display offerings with a compact cylindrical form that can be mounted in three ways: stem mounted for a free-standing fixture, attached to millwork with a fixed mounting plate, or mounted into a base that allows 360° rotation. Elegance Cylinder fixtures provide bright, focused illumination for accent, niche or display applications.

Elegance Cylinder features Nichia LEDs and can be driven at either 700mA or at 1050mA. Reflector accessories in Narrow, Medium or Wide make it an ideal fixture for fully illuminating small displays or adding a spotlight to larger casework. The adjustable head of the Elegance Cylinder has a range of 130° and fully recessed reflectors snap in and out with a simple tool, making them easily changeable in the field.

Constant current and dimmable via 0-10 dimming; CRI up to 95+; black or silver finish. LED component can be replaced in the field by trained technician.

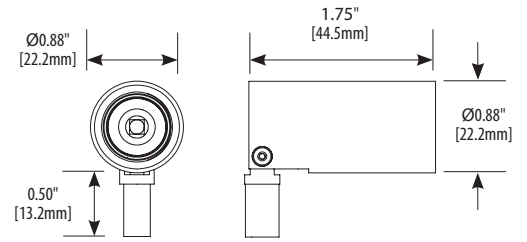
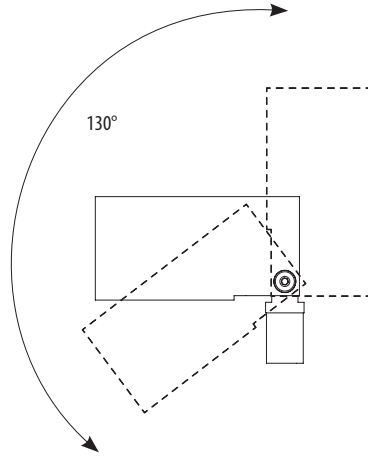
Visit the VLT website for application photos and most recent information.

CCT	2700K	3000K	3500K	4000K	4500K
LIGHT OUTPUT CONVERSION	0.88	1.0	1.0	1.08	1.08

VLT reserves the right to change specifications without notice. Please visit [www.vltcorp.com](http://www.vltcorp.com) for current cut sheets.

MADE IN USA 





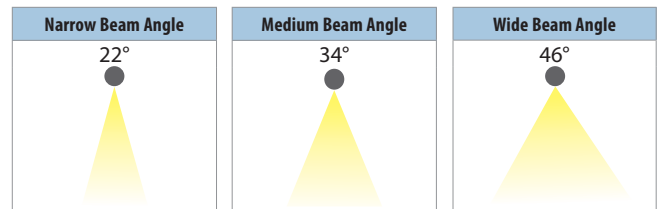
ELEGANCE CYLINDER

IP20 | Compact cylindrical accent fixture for use with stem mount or mounting plate. Constant Current fixture drivable at 700mA or 1050mA with either 87 or 95+ CRI in various color temperatures. Nichia 219 LEDs include +/- 60° Micro-Binning. For display or accent applications; fixture head provides 130° tilt range. Available with Narrow, Medium or Wide optic reflectors; optics fully recess within fixture head. Black, Silver or Custom finish.

Photometrics vary based on CCT and CRI; see photometrics page for conversion.



See Optic Reflector Accessories on Page 86.



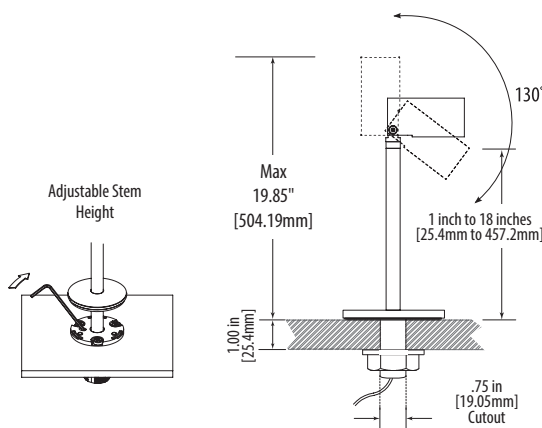
ELL- CYL -

LED		CCT		Finish	Lens Options	Listings & Mounting Options
1250	87 CRI	27	2700°K	AL Silver	N Narrow	UL UL Listed
1250H	95+ CRI <sup>1</sup>	30	3000°K	BL Black	M Medium	CE CE Marked (RoHS)
		35	3500°K	C Custom	W Wide	BU Bushing Mount
		40	4000°K			SB Surface Mount w/ Wire Exit through Base
		45	4500°K			SR Surface Mount w/ Wire Exit from Rear
						FS6 8mm Free Stand Mount 6" [152.4mm]
						FS12 8mm Free Stand Mount 12" [304.8mm]
						FS18 8mm Free Stand Mount 18" [457.2mm]

Standard
HI CRI  
<sup>1</sup> Not Available in 4500°K

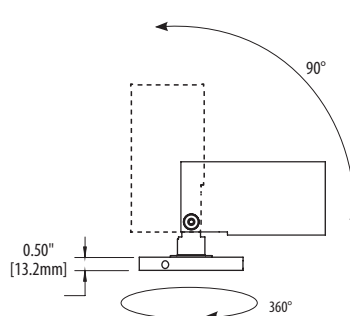
MOUNTING OPTIONS

FREE STAND MOUNT (FS6, FS12, FS18)



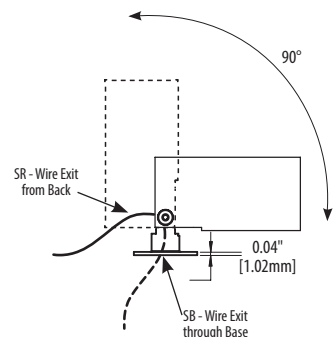
Free Stand Mount available in three stem height options; further height adjustment possible via set screw in fixture base. Free Stand Mount can be installed via screws from top surface, or with nut on rear side (no more than 1" mounting surface thickness recommended.) Fixture head has full 130° tilt range. Top surface mount allows 360° rotation after installation; nut on rear side does not. See Special Mounting Options for bushing installation details.

BUSHING MOUNT (BU)  
90° TILT/360° ROTATION



Fixture head tilts 90° and rotates 360°. Mount provides the finished look of a ferrule at fixture base; position can be fixed with set screw. Wire feeds through fixture base.

SURFACE MOUNT (SB OR SR)  
90° TILT/NO ROTATION



Surface Mount option allows installation of fixture via screws from top surface; no rear access necessary, all mounting surface thicknesses okay. Fixture head tilts 90°, no rotation. Wire can exit thru Base (SB) or from rear of fixture (SR).

## ELEGANCE LONG FUNDAMENTALS

All LEDs binned to within a 2 MacAdam ellipse CCT tolerance of ±60°.

	4224C/350mA Driver	4224C/500mA Driver	4224H/350mA Driver	4224H/500mA Driver
<b>LUMEN OUTPUT</b>	366 lm	485 lm	355 lm	470 lm
<b>FIXTURE WATTAGE</b>	4.2w	6.2w	4.2w	6.2w
<b>CRI</b>	87	87	95+	95+
<b>CCT OPTIONS</b>	2700K, 3000K, 3500K, 4000K, 4500K		2700K, 3000K, 3500K, 4000K	
<b>APPLIED LED</b>	Nichia 219C	Nichia 219C	Nichia 219C	Nichia 219C
<b>LED EFFICACY*</b>	94 lm/w	94 lm/w	91 lm/w	91 lm/w
<b>FIXTURE EFFICACY* not including driver losses</b>	87 lm/w	78 lm/w	85 lm/w	76 lm/w

Beam	Lumens @350mA	Footcandles @ 12"	Lumens @500mA	Footcandles @ 12"
15°	366 lm	1440 fc	485	1876 fc
30°	356 lm	1110 fc	463	1365 fc
60°	296 lm	557 fc	392	732 fc
30° x 60°	347 lm	1057 fc	463	1354 fc

All photometrics based on 3500K CCT

<b>LENSING</b>	15°, 30°, 60° and 30° x 60°
<b>FINISH</b>	Silver, Black, Custom finishes on request
<b>DIMENSIONS</b>	2.20" x 0.98" x 0.47" [56.0mm x 25.0mm x 12.0mm]
<b>ELECTRICAL</b>	<p><b>Driver Type:</b> Constant Current, 350mA or 500mA, Class 2 UL Listed</p> <p><b>Input Voltage:</b> 12.7v</p> <p><b>Dimming:</b> 0-10 v, Dali, DMX (See Driver Cutsheet)</p> <p><b>Feed Wire:</b> 96" [2.44m] of 20 AWG Wire [1.02mm<sup>2</sup>], Male Connector</p> <p><b>Operating Ambient Temperature:</b> -22° to 104° F [-30° to 40° C]</p>
<b>LIFE &amp; WARRANTY</b>	50,000 HR lifetime (T <sub>90</sub> = -25°C to 35°C; T <sub>c</sub> max 75°C); 5 year limited warranty
<b>MOUNTING</b>	Multiple options including stems, bushings and surface mount
<b>LISTINGS &amp; TESTS</b>	<p>UL<sub>us</sub> (2108, 8750); CE RoHS Compliant (if specified); LM79, LM80; IP20, Dry Location Only</p> <p>The EU's Restriction of Hazardous Substances Directive (RoHS) restricts the use of six hazardous substances* in electrical and electronic equipment (* Lead (Pb), Mercury, Cadmium, Hexavalent chromium, Polybrominated biphenyls and Polybrominated diphenyl ether (PBDE)).</p>



The EssentialLEDs® **Elegance Long** fixture offers a larger fixture body, allowing Elegance Long to run at 350mA or 500mA with light output up to 485 lumens. The high light output, low energy use, and long lamp life make Elegance Long an ideal fixture for fully illuminating small displays, or adding focused high-lights to larger casework. The adjustable head has a tilt range of +/- 90° to accommodate changing display needs.

Elegance Long offers 15°, 30°, 60° and 30° x 60° lensing options, with the 30 x 60 lens creating an oval light distribution that is ideal for illuminating elongated merchandise such as handbags and jewelry. Stem Mount (ST1 or ST2) mounts directly into millwork, while Surface Mount (SU) and Bushing Mount (BU) options include finished look of a fixture base.

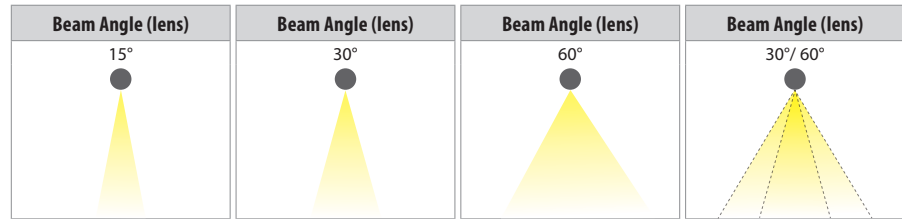
Elegance Long fixtures are dimmable and available in five color temperatures, with a CRI up to 95+; LED component can be replaced in the field by trained technician.

Visit the VLT website for application photos and most recent information.

CCT	2700K	3000K	3500K	4000K	4500K
<b>LIGHT OUTPUT CONVERSION</b>	0.88	1.0	1.0	1.08	1.08

VLT reserves the right to change specifications without notice. Please visit [www.vltcorp.com](http://www.vltcorp.com) for current cut sheets.

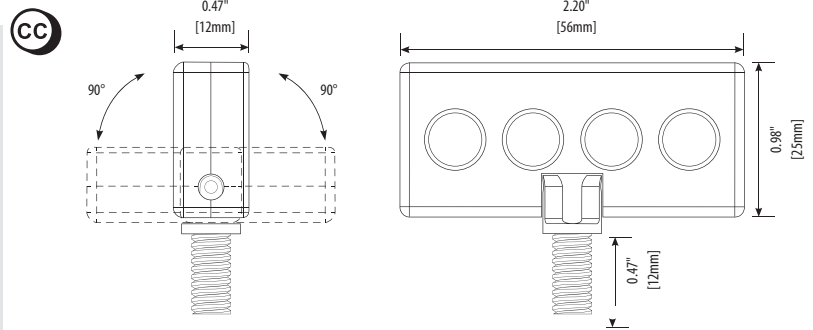




ELEGANCE LONG

IP20 | Compact rectangular fixture featuring specialized Constant Current LED board and lensing for display applications. Includes Nichia LEDs with either 87 or 95+ CRI in various color temperatures. All LEDs include ±60K Micro Binning. Fixture head tilts +/- 90°, with 15°, 30°, 60° or 30°x60° lens options. Silver, Black or Custom Finishes. Multiple mounting options available.

Photometrics vary based on CCT and CRI; see photometrics page for conversion.

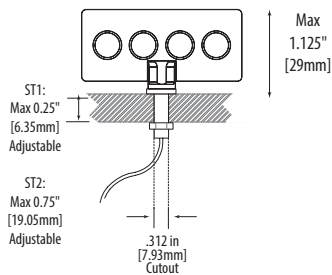


ELL- EGL -

LED		CCT		Finish		Lens Options		Wire Exit		Listings & Mounting Options	
4224C	87 CRI	27	2700°K	AL	Silver	15	15° Lens	WE1	Default	UL	UL Listed
4224H	95+ CRI <sup>1</sup>	30	3000°K	BL	Black	30	30° Lens			CE	CE Marked (RoHS)
		35	3500°K	C	Custom	60	60° Lens			ST1	Stem Mount, 0.25" [6.35mm] max, Adjustable
		40	4000°K			3060	30° x 60°			ST2	Stem Mount, 0.75" [19.05mm] max, Adjustable
		45	4500°K							BU	Bushing Mount
										SU	Surface Mount

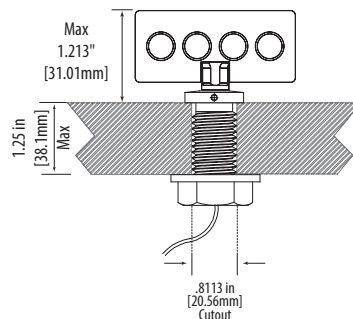
MOUNTING OPTIONS

STEM MOUNT (ST1, ST2)



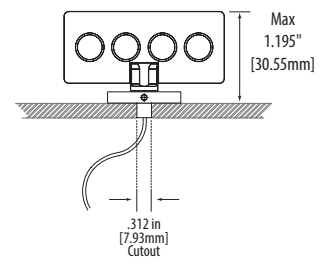
Stem Mount provides most minimal mounting option; stem attaches with nut on rear side of mounting surface; no rotation. Choose ST1 or ST2 based on the thickness of mounting surface.  
 Max thickness for ST1: 0.25" [6.35mm]  
 Max thickness for ST2: 0.75" [19.05mm]

BUSHING MOUNT (BU)



Bushing Mount provides the finished look of a ferrule at fixture base, allows 360° rotation of fixture head; position can be fixed with set screw. Bushing is attached with nut on rear side of mounting surface. Maximum mounting surface thickness 1.25" [38.1mm].

SURFACE MOUNT (SU)



Surface Mount option allows installation of fixture with screws to top surface, no rear access necessary. Surface Mount allows 360° rotation of fixture head; position can be fixed with set screw.

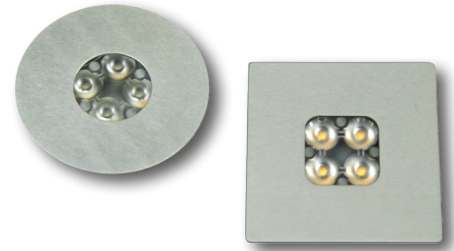
## ELEGANCE PUCK FUNDAMENTALS

All LEDs binned to within a 2 MacAdam ellipse CCT tolerance of  $\pm 60^\circ$

	4219C/350mA Driver/Round	4219C/350mA Driver/Square	4219H/350mA Driver/Round	4219H/350mA Driver/Square
LUMEN OUTPUT	285 lm	312 lm	276 lm	303 lm
FIXTURE WATTAGE	4.4w	4.4w	4.4w	4.4w
CRI	87	87	95+	95+
CCT OPTIONS	2700K, 3000K, 3500K, 4000K, 4500K		2700K, 3000K, 3500K, 4000K	
APPLIED LED	Nichia 219C	Nichia 219C	Nichia 219C	Nichia 219C
LED EFFICACY*	94 lm/w	94 lm/w	91 lm/w	91 lm/w
FIXTURE EFFICACY* not including driver losses	65 lm/w	71 lm/w	63 lm/w	69 lm/w

All photometrics based on 3500K CCT

Visit the VLT website for application photos and most recent IES files.





EssentialLEDs® **Elegance Puck** fixtures offer impressive light output, low energy use and long lamp life in a compact, low-profile form. Round and Square Pucks can be recess mounted, and the Round Puck can also be surface mounted with available accessory housing. Elegance Puck fixtures can provide full illumination for small displays, or add focused highlights in larger casework.

Round or Square fixtures offer 15°, 30°, 60° or 30° x 60° lensing options; 30° x 60° option creates an oval light distribution ideal for illuminating elongated merchandise such as handbags or jewelry.

Elegance Puck fixtures are dimmable and available in various color temperatures, with a CRI of up to 95+. The LED component can be replaced in the field by a trained technician.

MADE IN USA 

LENSING	15°, 30°, 60° and 30° x 60°
FINISH	Silver, Black, White, Bronze, Chrome
DIMENSIONS	Round: 1.969" [50.00mm] Diameter, 0.531" [13.50mm] Thick Square: 1.969" [50.00mm] x 1.969" [50.00mm]
ELECTRICAL	<b>Driver Type:</b> Constant Current, 350mA, Class 2 UL Listed <b>Input Voltage:</b> 12.7v <b>Dimming:</b> 0-10 v, DMX, DALI (see Driver Cut Sheet) <b>Feed Wire:</b> 96" [2.44m] of 20 AWG Wire [1.02mm <sup>2</sup> ], Male Connector <b>Operating Ambient Temperature:</b> -22° to 104° F [-30° to 40° C]
LIFE & WARRANTY	50,000 HR lifetime (T <sub>a</sub> = -25°C to 35°C; T <sub>c</sub> max 75°C); 5 year limited warranty
MOUNTING	Square: Recessed Round: Recessed and Surface mount
LISTINGS & TESTS	 (2108, 8750);  RoHS Compliant (if specified); LM79, LM80; IP20, Dry Location Only The EU's Restriction of Hazardous Substances Directive (RoHS) restricts the use of six hazardous substances* in electrical and electronic equipment (* Lead (Pb), Mercury, Cadmium, Hexavalent chromium, Polybrominated biphenyls and Polybrominated diphenyl ether (PBDE)).



Beam	Lumens	Footcandles @ 12"
15°	312 lm	1555 fc
30°	314 lm	963 fc
60°	285 lm	510 fc
30° x 60°	308 lm	367 fc

Beam	Lumens	Footcandles @ 12"
15°	343 lm	1741 fc
30°	325 lm	1078 fc
60°	312 lm	591 fc
30° x 60°	274 lm	459 fc

CCT	2700K	3000K	3500K	4000K	4500K
LIGHT OUTPUT CONVERSION	0.88	1.0	1.0	1.08	1.08

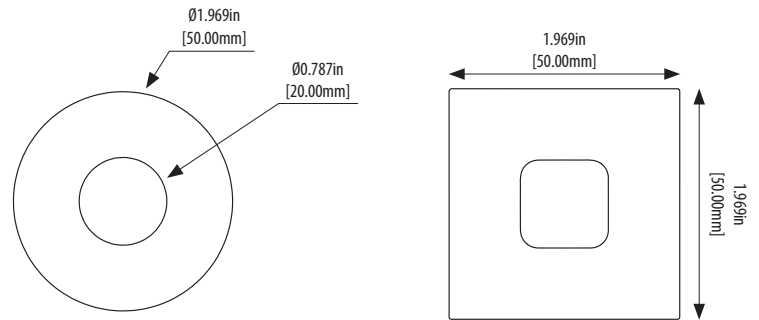
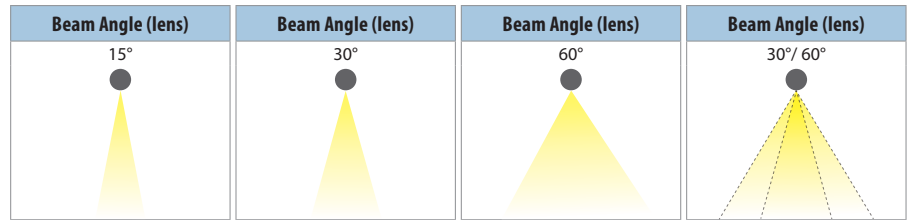
VLT reserves the right to change specifications without notice. Please visit [www.vltcorp.com](http://www.vltcorp.com) for current cut sheets.



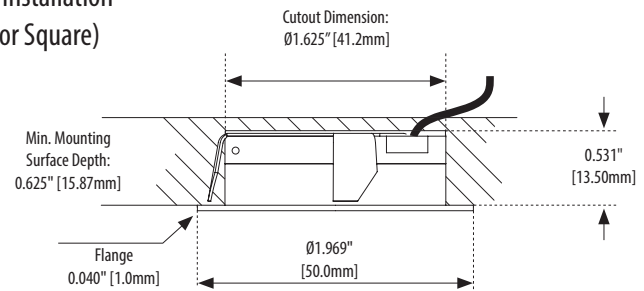
ELEGANCE PUCK

IP20 | Compact low-profile puck fixture with round or square face plate, featuring specialized Constant Current LED board and lensing for display applications. Includes Nichia LEDs with either 87 or 95+ CRI in various color temperatures. All LEDs include ±60K Micro Binning. For recessed mounting (or surface mounting using housing accessory.) Available with 15°, 30°, 60° or 30°x60° lens options. Available in Silver or Black Anodized, Bronze or White Powder Coated, Chrome or Custom Finishes.

Photometrics vary based on CCT, fixture shape and lensing.



Recessed Installation  
(Round or Square)



ELL-

Shape		LED		CCT		Finish		Lens Options		Wire Exit	Listings		
EPR	Round	4219C	87 CRI	27	2700°K	AL	Silver	15	15° Lens	WE1	Default	UL	UL Listed
EPS	Square	4219H	95+ CRI <sup>1</sup>	30	3000°K	BL	Black	30	30° Lens			CE	CE Marked (RoHS)
				35	3500°K	BZ	Bronze	60	60° Lens				
				40	4000°K	WH	White	3060	30° x 60°				
				45	4500°K	CH	Chrome						

Standard
  HI CRI

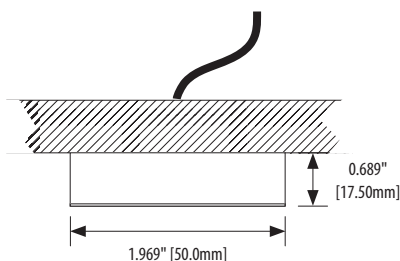
<sup>1</sup> Not Available in 4500°K CCT

SURFACE MOUNT ACCESSORY (ROUND ONLY)

SPECIFICATIONS

CAT. NO. ELL-AC-EPR-SMA-

Surface Mount Installation



Dimensions: 1.969" [50.0mm] x 0.689" [17.50mm]

Material: Aluminum

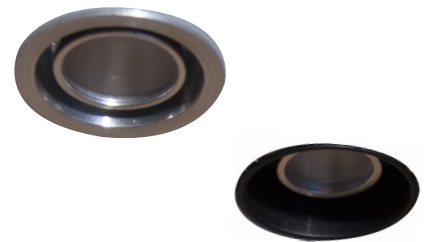
**Description:** Surface Mount Accessory housing converts Elegance Puck Round fixture into surface mount fixture. Housing screws to mounting surface with two screws (provided); Elegance Puck Round fixture snaps into housing. One per fixture. Overall height including fixture is 0.70in (18.0mm); Silver (AL), Black (BL), Bronze (BZ) or White (WH) finish to match fixture.

AL
BL
BZ
WH
CH

## ELEGANCE MINI - PUCK FUNDAMENTALS

All LEDs binned to within a 2 MacAdam ellipse CCT tolerance of  $\pm 60^\circ$ .

	1250 / 700mA Driver	1250H / 700mA Driver
LUMEN OUTPUT	127 lm	123 lm
FIXTURE WATTAGE	2.4	2.4
CRI	87	95+
CCT OPTIONS	2700K, 3000K, 3500K, 4000K 4500K	2700K, 3000K, 3500K, 4000K
APPLIED LED	Nichia 219C	Nichia 219C
LED EFFICACY*	94 lm/w	91 lm/w
FIXTURE EFFICACY* not including driver losses	53 lm/w	51 lm/w



- 2.5 watt
- Recessed Accent Fixture
- Flanged or Trimless
- Easy Install with Spring Clip

Elegance Mini-Pucks provide bright, focused illumination for accent, niche or display applications. Mini-Puck features Nichia LEDs with up to 95+ CRI.

Available in Trimless or Flanged Style. Clever Reflector Accessories pop in and out with a simple tool, offering quick changes between Narrow, Medium or Wide optics. In both versions, optics fully recess within fixture.

Flanged version available in Silver, Black, Bronze, White or Custom finishes with Silver Reflector. Trimless version Black only with Silver Reflector.

Spring clips provide easy recess installation into millwork, drywall or acoustic tile mounting surfaces. Constant current, dimmable via 0-10v dimming.

All photometrics based on 3500K CCT using a wide lens

LENSING	Narrow, Medium or Wide Individual Reflectors, Interchangeable in Field
FINISH	Flanged: Silver, Black, Bronze, White & Custom Finishes on request Trimless: Black Only
ELECTRICAL	<b>Driver Type:</b> Constant Current, 700mA or 1050mA, Class 2 UL Listed <b>Input Voltage:</b> 3v <b>Dimming:</b> 0-10 v, DMX, DALI (See Driver Cutsheet) <b>Feed Wire:</b> 96" [2.44m] of 20 AWG Wire [1.02mm <sup>2</sup> ], Male Connector <b>Operating Ambient Temperature:</b> -22° to 95° F [-30° to 40° C] <b>Humidity:</b> 90% RH Non-Condensing
LIFE & WARRANTY	50,000 HR lifetime ( $T_a = -25^\circ\text{C}$ to $40^\circ\text{C}$ ; $T_c$ max $75^\circ\text{C}$ ); 5 year limited warranty
MOUNTING	Tension Mount with Spring Trimless Style Cutout Dimension: 7/8" [22.22mm] Flanged Style Cutout Dimension: 15/16" [23.81mm]
LISTINGS & TESTS	cULus (2108, 8750); CE RoHS Compliant (if specified); LM79, LM80; IP20, Dry Location Only The EU's Restriction of Hazardous Substances Directive (RoHS) restricts the use of six hazardous substances* in electrical and electronic equipment (* Lead (Pb), Mercury, Cadmium, Hexavalent chromium, Polybrominated biphenyls and Polybrominated diphenyl ether (PBDE)).



MADE IN USA

Beam	Lumens	Footcandles @ 12"
Narrow	115 lm	435 fc
Medium	127 lm	300 fc
Wide	86 lm	139 fc

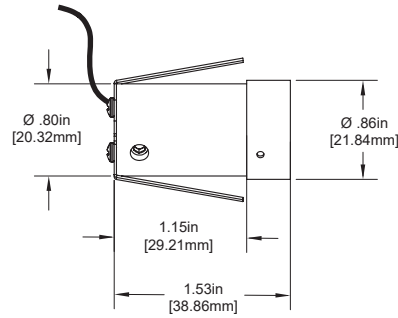
CCT	2700K	3000K	3500K	4000K	4500K
LIGHT OUTPUT CONVERSION	0.88	1.0	1.0	1.08	1.08

VLT reserves the right to change specifications without notice. Please visit [www.vltpcorp.com](http://www.vltpcorp.com) for current cut sheets.

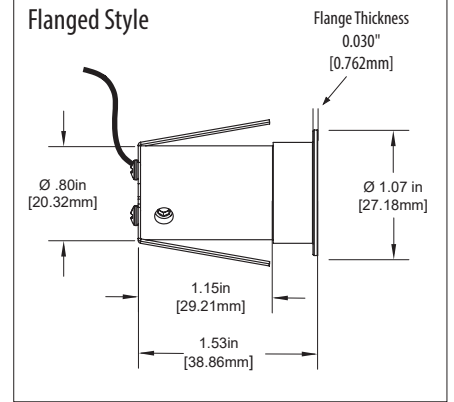




Trimless Style



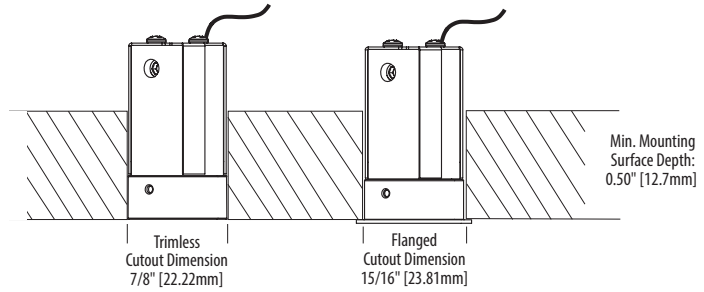
Flanged Style



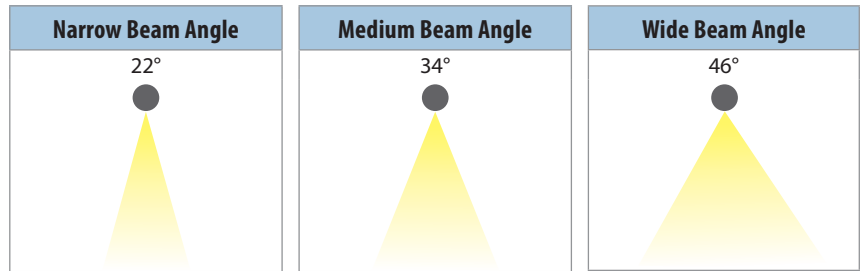
ELEGANCE MINI-PUCK

IP20 | Compact recessed accent fixture, fully-recessed trimless style or low-profile flanged style. Features Constant Current Nichia LEDs with either 87 or 95+ CRI in various color temperatures. All LEDs include ±60° Micro Binning. For display or accent applications; spring clip provides easy installation into millwork, drywall or acoustic tile mounting surfaces. Available with interchangeable Narrow, Medium or Wide optic reflectors. Flanged version available in Silver, Black, Bronze, White or Custom Finishes with Silver Reflector. Trimless version Black only with Silver Reflector.

Photometrics vary based on CCT and lensing.



See Elegance Mini Puck & Cylinder Accessories page for more information.



ELL-

Style		LED		CCT		Finish		Lens Options		Listings	
MPF	Flanged	1250	87 CRI	27	2700°K	AL	Silver	N	Narrow	UL	UL Listed
MPTL	Trimless	1250H	95+ CRI <sup>1</sup>	30	3000°K	BL	Black <sup>2</sup>	M	Medium	CE	CE Marked (RoHS)
				35	3500°K	BZ	Bronze	W	Wide		
				40	4000°K	WH	White				
				45	4500°K	C	Custom				

Standard HI CRI

<sup>1</sup> Not Available in 4500°K CCT

<sup>2</sup> Trimless Fixture in Black Only





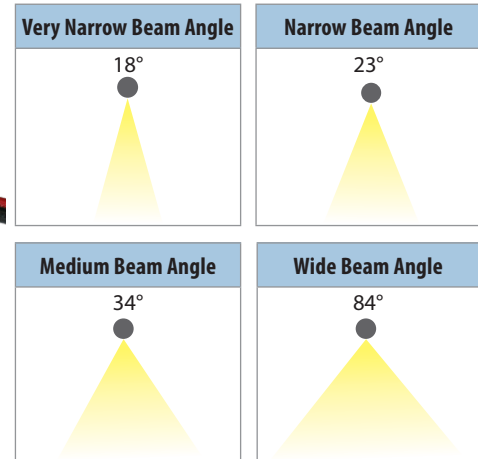
## New! ELEGANCE MICRO-PUCK FUNDAMENTALS

All LEDs binned to within a 2 MacAdam ellipse CCT tolerance of  $\pm 60^\circ$ .

	1239 / 350mA Driver	1239H / 350mA Driver
LUMEN OUTPUT	95 lm	92 lm
FIXTURE WATTAGE	1.1	1.1
CRI	87	95+
CCT OPTIONS	2700K, 3000K, 3500K, 4000K, 4500K	2700K, 3000K, 3500K, 4000K
APPLIED LED	Nichia 219C	Nichia 219C
LED EFFICACY*	94 lm/w	91 lm/w
FIXTURE EFFICACY* not including driver losses	95 lm/w	92 lm/w



- 1 watt
- Super Small
- Super Bright



All photometrics based on 3500K CCT using a wide lens

LENSING	Narrow, Medium or Wide Lens
FINISH	Silver, Black, Bronze, White, Custom Finishes on Request
ELECTRICAL	<p><b>Driver Type:</b> Constant Current, 350mA, Class 2 UL Listed</p> <p><b>Input Voltage:</b> 3v</p> <p><b>Dimming:</b> 0-10 v, DMX, DALI</p> <p><b>Feed Wire:</b> 96" [2.44m] of 20 AWG Wire [1.02mm<sup>2</sup>], Male Connector</p> <p><b>Operating Ambient Temperature:</b> -22° to 95° F [-30° to 40° C]</p> <p><b>Humidity:</b> 90% Non-Condensing</p>
LIFE & WARRANTY	50,000 HR lifetime ( $T_a = -25^\circ\text{C}$ to $40^\circ\text{C}$ ; $T_c$ max $75^\circ\text{C}$ ); 5 year limited warranty
MOUNTING	Adhesive, Press Fit, Mounting Clip or Magnet
LISTINGS & TESTS	<p>UL (2108, 8750); CE RoHS Compliant (if specified); LM79, LM80; IP20, Dry Location Only</p> <p>The EU's Restriction of Hazardous Substances Directive (RoHS) restricts the use of six hazardous substances* in electrical and electronic equipment (* Lead (Pb), Mercury, Cadmium, Hexavalent chromium, Polybrominated biphenyls and Polybrominated diphenyl ether (PBDE)).</p>

Our smallest fixture ever, the new **Elegance Micro-Puck** was designed to focus a small, bright light on a single specific product. Ideal for displays that project light up into glass objects (i.e. vases, art glass, perfume bottle). Available with 18°, 23°, 34°, or 84° lens options.

Elegance **Micro-Puck Standard** can be recessed into millwork and fixed via adhesive, or press fit; optional mounting clip screws to the mounting surface and holds fixture flush to mounting surface. Elegance **Micro-Puck Magnet** attaches to any ferrous surface. Both versions are dimmable and available in various color temperatures up to 95+ CRI.

CCT	2700K	3000K	3500K	4000K	4500K
LIGHT OUTPUT CONVERSION	0.88	1.0	1.0	1.08	1.08

Beam	Lumens	Footcandles @ 12"
VN	322 lm	87 fc
N	349 lm	95 fc
M	198 lm	95 fc
W	58 lm	49 fc

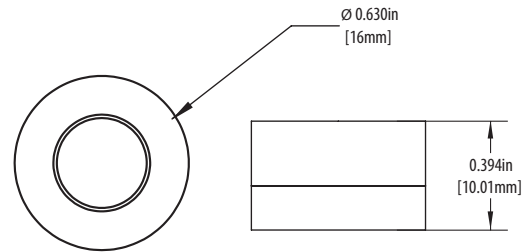
VLT reserves the right to change specifications without notice. Please visit [www.vltcorp.com](http://www.vltcorp.com) for current cut sheets.

MADE IN USA 

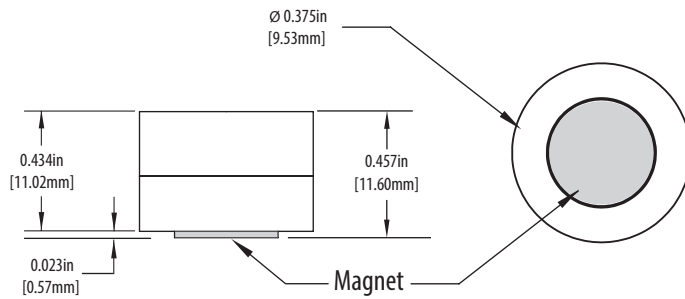
ELEGANCE MICRO-PUCK

IP20 | Super-small accent fixture for surface mount, recessed or magnet installation. Features Constant Current Nichia LED boards with either 87 or 95+ CRI in various color temperatures. All LEDs include ±60° Micro Binning. For display or accent applications; fixture can be glued or press fit, clipped to mounting surface using Side Mount Spring Clip, or attached via magnet to ferrous surface. Available with lens options from 18° - 84°. Available in Silver, Black, Bronze, White or Custom Finishes.

Photometrics vary based on CCT and lensing.



Without Magnet: 0.394" [10.01mm] Overall Height



With Magnet: 0.457" [11.60mm] Overall Height

Style		CCT		Finish		Lens Options		Listings & Mounting Options	
MPS	Micro Puck Standard	27	2700°K	AL	Silver	VN	18° Beam	UL	UL Listed
MPM	Micro Puck Magnet	30	3000°K	BL	Black	N	23° Beam	CE	CE Marked (RoHS)
		35	3500°K	BZ	Bronze	M	34° Beam		
		40	4000°K	WH	White	W	84° Beam		
		45	4500°K	C	Custom				

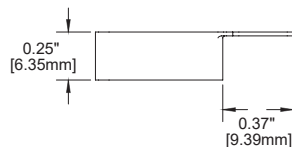
LED	
1239	87 CRI
1239H	95+ CRI <sup>1</sup>

■ Standard    ■ HI CRI  
<sup>1</sup> Not Available in 4500°K CCT

SIDE MOUNT SPRING CLIP

SPECIFICATIONS

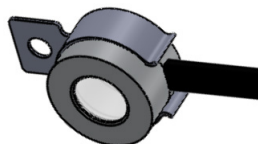
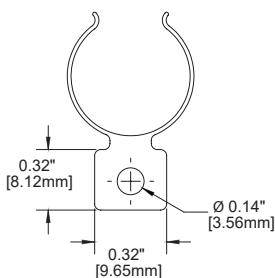
CAT. NO. ELL-AC-MCP-SMSC



Dimensions: 1.969" [50.0mm] x 0.689" [17.50mm]

Material: Aluminum

**Description:** Side Mount Spring Clip Accessory screws to mounting surface with screw provided; holds Micro-Puck flush to mounting surface.



## LIGHTRUN FUNDAMENTALS

All LEDs binned to within a 2 MacAdam ellipse CCT tolerance of  $\pm 60^\circ$ .

1184 LED Board available in **2700K, 3000K, 3500K, 4000K, 4500K & 5000K.**

	1184/ 700mA Driver	
LUMEN OUTPUT	STANDARD 400 lm/ft [1312 lm/m]	ELEVATED 556 lm/ft [1824 lm/m]
POWER CONSUMPTION not including driver losses	6.6w/ft [20.7w/m]	
APPLIED LED	Nichia 157B	
LED EFFICACY	108 lm/w	
FIXTURE EFFICACY not including driver losses	63 lm/w	

All photometrics based on 3500K CCT

LENSING	Diffuse lens
FINISH	Silver or Black Anodized, Bronze or White Powder Coated, or Custom Finishes on request
LENGTHS	Up to 58.66" [1490mm]; see Length & Wattage Table for all standard length options
ELECTRICAL	<b>Driver Type:</b> Constant Current, 700mA, Class 2 UL Listed <b>Input Voltage:</b> 4v - 40v <b>Dimming:</b> 0-10V, DALI, DMX <b>Feed Wire:</b> 96" [2.44m] of 20 AWG Wire [1.02mm <sup>2</sup> ], Male Connector <b>Operating Ambient Temperature:</b> -22° to 95° F [-30° to 35° C]
LIFE & WARRANTY	50,000 HR lifetime ( $T_a = -25^\circ\text{C}$ to $35^\circ\text{C}$ ; $T_c$ max $75^\circ\text{C}$ ); 5 year limited warranty
MOUNTING	Fixed or Adjustable Mounting Clips
LISTINGS & TESTS	cUL <sub>us</sub> (UL 2108 & 8750); CE RoHS Compliant (if specified); LM79, LM80 ; IP20, Dry Location Only The EU's Restriction of Hazardous Substances Directive (RoHS) restricts the use of six hazardous substances* in electrical and electronic equipment (* Lead (Pb), Mercury, Cadmium, Hexavalent chromium, Polybrominated biphenyls and Polybrominated diphenyl ether (PBDE)).

The EssentialLEDs® **LightRun** fixture was developed for use in retail display applications where the bright reflection of individual LED diodes can be an unwelcome visual distraction.

LightRun features a proprietary 1184 LED board and unique diffuse lens. LightRun creates a single linear light source that eliminates individual diode reflections and beautifully illuminates the details of designer handbags, small leather goods and other types of highly detailed merchandise.

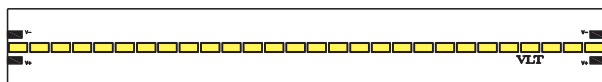
LightRun uses dimmable LEDs in six color temperatures. It is available in 3.858" [98.00mm] increments up to a length of 58.66" [1490mm].

Visit the VLT website for application photos and most recent information.

MADE IN USA 

CCT	2700K	3000K	3500K	4000K	4500K	5000K
LIGHT OUTPUT CONVERSION	0.88	1.0	1.0	1.08	1.08	1.08

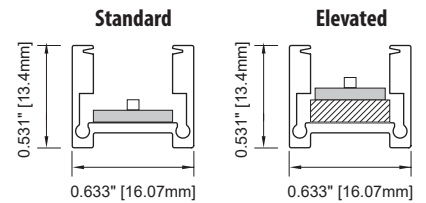
VLT reserves the right to change specifications without notice. Please visit [www.vltcorp.com](http://www.vltcorp.com) for current cut sheets.



LightRun's proprietary LED board places the LEDs right next to each other, for a continuous run of light.

LIGHTRUN - LENSED

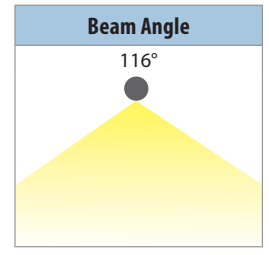
IP20 | Medium square extrusion with specialized Constant Current LED board and diffuse lens for linear lighting in display applications. Dry location. Includes one row of Nichia LEDs (400lm/ft<sup>1</sup>, 6.6w/ft<sup>1</sup>, 87 CRI). Standard color temperatures of 2700K, 3000K, 3500K, 4000K, 4500K and 5000K. All LEDs include ±60K Micro Binning. Available in Silver or Black Anodized, Bronze or White Powder Coated, or Custom Finishes. Optional Elevated LED board increases light output with slightly more noticeable hotspots.



ELL-LR - \_\_\_\_\_ - \_\_\_\_\_ - \_\_\_\_\_ - \_\_\_\_\_ - \_\_\_\_\_ - \_\_\_\_\_ - \_\_\_\_\_ - \_\_\_\_\_

LED	CCT	Finish	Lens Options	Wire Exit	Fixtures Length	Listings & Options
1184 400 lm/ft <sup>1</sup> , 6.6 w/ft <sup>1</sup> , 87 CRI	27 2700°K 30 3000°K 35 3500°K 40 4000°K 45 4500°K 50 5000°K	AL Silver Anodized BL Black Anodized BZ Bronze WH White C Custom	DL Diffuse Lens D2 Holographic Film	WE1 Default	See Fixture Length and Wattage Table. Choose the correct Code number for the LED board and fixture length of your choice or specify Custom Length as follows: C (12.25") C [311mm]	UL UL Listed CE CE Marked EL Elevated MAG Magnetic Mount

<sup>1</sup>Based on Standard LED Placement



Fixture Accessories			
ELL-AC-LR-MC	ELL-AC-LR-AMC	ELL-AC-S123-AB	Factory Installed; See Options Above
<p><b>Fixed Metal Clip.</b> Extrusion snaps into clip. Can be used in conjunction with Adjustable Bracket.</p>	<p><b>Adjustable Metal Clip</b> with offset screw attachment for flush mount; bends to desired angle.</p>	<p><b>Metal Hinged Bracket</b> for use in conjunction with fixed metal clip; allows 30° adjustability, repeated adjustments, and simplifies angled adjustments in hard-to-reach areas.</p>	<p><b>Magnetic Mount</b> Small, strong, factory installed magnets recess into rear side of fixture extrusions for mounting of fixture onto suitable ferrous surface or accessory Steel Mounting Plates. 3 magnets per foot. Magnets protrude 0.09" [2.3mm] from back of fixture.</p>

## FIXTURE LENGTH & WATTAGE TABLE - LIGHTRUN

Use Code numbers to specify Standard Length extrusions.

Code	Fixture Lengths	1184
		LightRun
4	4.65" [118mm]	2.2w
8	8.50" [216mm]	4.4w
12	12.36" [314mm]	6.6w
16	16.22" [412mm]	8.8w
20	20.07" [510mm]	11.0w
24	23.94" [608mm]	13.2w
28	27.80" [706mm]	15.4w
32	31.65" [804mm]	17.6w
36	35.51" [902mm]	19.8w
40	39.37" [1000mm]	22.0w
44	43.22" [1098mm]	24.2w
48	47.08" [1196mm]	26.4w
52	50.94" [1294mm]	28.6w
56	54.80" [1392mm]	30.8w
60	58.66" [1490mm]	33.0w

**About Custom Length Fixtures:** the fixture lengths listed above are considered "standard" lengths. A fixture length that differs from these would be considered a "custom" length.

"Custom" length fixtures have an overall finished length (including end caps) **exactly** as specified. Because the LED boards are limited to 4" increments, the LED board that is the next size down will be centered inside the custom-length fixture.

LEDs have a generous field angle, so a fixture does not need to extend the full length of a cabinet, shelf or display case for the area to be fully lit. Custom fixtures are most often used where the fixture is **visible** and an exact-length is desired for **aesthetic** reasons.



## ORB FUNDAMENTALS

All LEDs binned to within a 2 MacAdam ellipse CCT tolerance of  $\pm 60^\circ$   
 Photometric and wattage data presented below is PER HEAD.

	1219B/ 700mA Driver	1219H/ 700mA Driver
LUMEN OUTPUT	151 lm	146 lm
FIXTURE WATTAGE	3.1 w	3.1 w
CRI	87	95+
CCT OPTIONS	2700K, 3000K, 3500K, 4000K, 4500K	2700K, 3000K, 3500K, 4000K
APPLIED LED	Nichia 219C	Nichia 219C
LED EFFICACY*	94 lm/w	91 lm/w
FIXTURE EFFICACY* not including driver losses	49 lm/w	47 lm/w

Beam	Lumens	Footcandles @ 12"
14°	138 lm	644 fc
29°	140 lm	579 fc
60°	97 lm	416 fc

All photometrics based on 3500K CCT

LENSING	14°, 29° or 60° Lens
FINISH	Silver, Black & Custom Finishes on request
ELECTRICAL	<b>Driver Type:</b> 700mA, Class 2 UL Listed <b>Input Voltage:</b> 3v - 6v <b>Dimming:</b> 0-10 v, DMX, DALI (See Driver Cutsheet) <b>Feed Wire:</b> 96" [2.44m] of 20 AWG Wire [1.02mm <sup>2</sup> ], Male Connector <b>Operating Ambient Temperature:</b> -22° to 95° F [-30° to 40° C] <b>Humidity:</b> 90% RH Non-Condensing
LIFE & WARRANTY	50,000 HR lifetime (T <sub>a</sub> = -25°C to 40°C; T <sub>c</sub> max 75°C); 5 year limited warranty
MOUNTING	Mounting V Flange standard
LISTINGS & TESTS	eULus (2108, 8750); CE RoHS Compliant (if specified); LM79, LM80 ; IP20, Dry Location Only The EU's Restriction of Hazardous Substances Directive (RoHS) restricts the use of six hazardous substances* in electrical and electronic equipment (* Lead (Pb), Mercury, Cadmium, Hexavalent chromium, Polybrominated biphenyls and Polybrominated diphenyl ether (PBDE)).

The EssentialLEDs® **Orb** fixture was developed for use in retail display applications, with rotatable heads seated into a self-mounting angled housing; heads rotate independently and lock securely in desired position.

The Orb housing tucks neatly into top, bottom, or side corners of display windows, niches or millwork. From one to six rotatable heads available in 14°, 29° or 60° lens options. Orb's high light output, low energy use and long lamp life make it an ideal fixture for beautifully illuminating displays of jewelry, handbags and other types of highly detailed merchandise.

Orb fixtures are dimmable and available in various color temperatures, with a CRI of up to 95+. LED component can be replaced in field by trained technician.

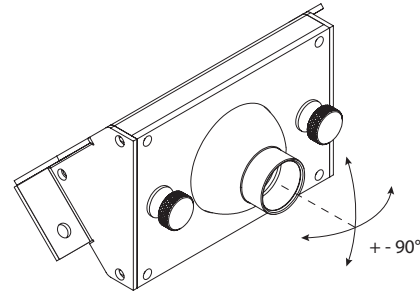
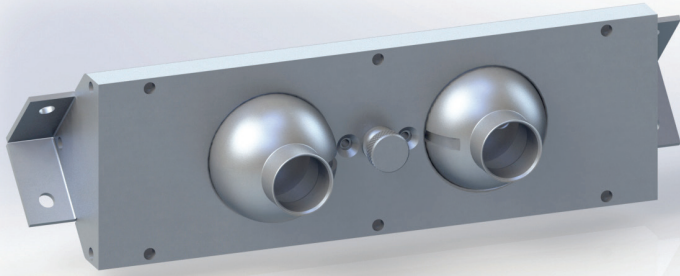
Visit the VLT website for application photos and most recent information.

MADE IN USA 

CCT	2700K	3000K	3500K	4000K	4500K
LIGHT OUTPUT CONVERSION	0.88	1.0	1.0	1.08	1.08

VLT reserves the right to change specifications without notice. Please visit [www.vltcorp.com](http://www.vltcorp.com) for current cut sheets.

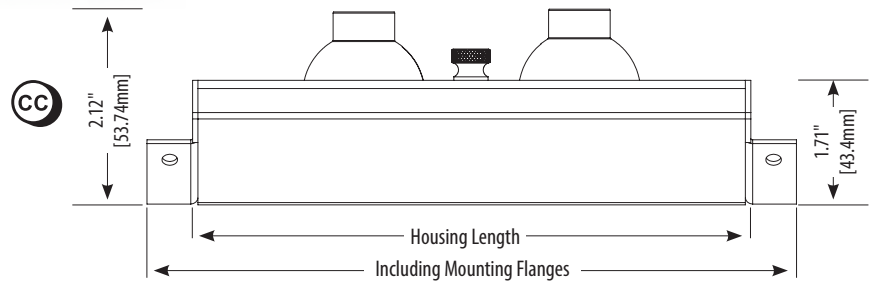




ORB

IP20 | Display lighting fixture featuring 90° angled mounting housing combined with 1, 2, 4 or 6 rotatable spherical LED lighting heads. Each head includes one Nichia LED (up to 151 lm\*, up to 3.1 w, 87 CRI). Heads available with 14°, 29° or 60° lens and lock securely in desired position. Total Fixture Length between 4.118" and 16.56" [420.6mm] (Depending on head count.) Total Fixture Wattage varies based on head quantity and driver current. Available in 2700K, 3000K, 3500K, 4000K, 4500K. All LEDs include ±60K Micro Binning. Silver, Black or Custom Finishes.

Photometrics vary based on CCT.



Number of Heads	Housing Length	Including Mounting Flanges
1 Head	3.118" [79.1mm]	4.118" [104.5mm]
2 Heads	6.00" [152.4mm]	7.11" [180.5mm]
4 Heads	10.72" [272.8mm]	11.83" [300.5mm]
6 Heads	15.45" [392.4mm]	16.56" [420.6mm]

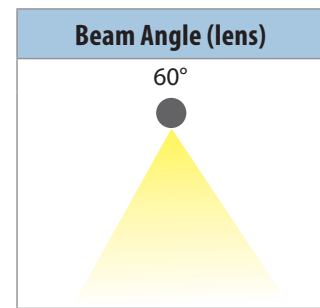
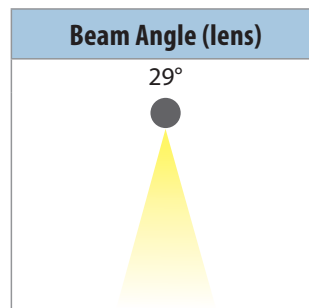
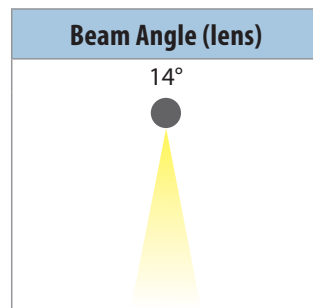
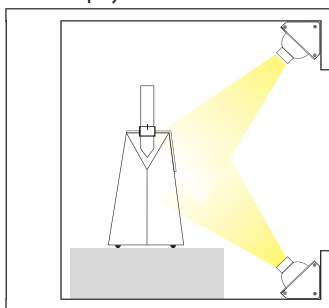
ELL-OR -

LED	CCT	Finish	Lens Options	Wire Exit	Listings
1219B 87 CRI	27 2700°K	AL Silver	14 14° Lens	WE1 Default	UL UL Listed
1219H 95+ CRI <sup>1</sup>	30 3000°K	BL Black	29 29° Lens		CE CE Marked (RoHS)
	35 3500°K	C Custom	60 60° Lens		
	40 4000°K				
	45 4500°K				





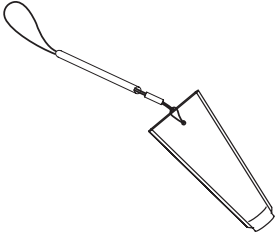

<sup>1</sup> Not available in 4500°K CCT

Number of Heads	
1	1 Head
2	2 Heads
4	4 Heads
6	6 Heads

Orb tucks into corners of display niches and windows



## ELEGANCE MINI PUCK & CYLINDER ACCESSORIES

NARROW REFLECTOR	SPECIFICATIONS	CAT. NO. ELL - AC - R - N
	<p>Dimensions: Ø0.634" x 0.606" [Ø16.1mm x 15.4mm]                      Material: Aluminum with Plastic Lens                      Finish: Silver</p>	<p><b>Description:</b> Narrow optic for use in Elegance Mini Puck or Elegance Cylinder fixture. Reflector snaps into fixture head; remove using Reflector Tool below.</p>
MEDIUM REFLECTOR	SPECIFICATIONS	CAT. NO. ELL - AC - R - M
	<p>Dimensions: Ø12.4" x 0.45" [Ø12.4mm x 11.4mm]                      Material: Aluminum with Plastic Lens                      Finish: Silver</p>	<p><b>Description:</b> Medium optic for use in Elegance Mini Puck or Elegance Cylinder fixture. Reflector snaps into fixture head; remove using Reflector Tool below.</p>
WIDE REFLECTOR	SPECIFICATIONS	CAT. NO. ELL - AC - R - W
	<p>Dimensions: Ø0.52" x 0.37" [Ø13.2mm x 9.4mm]                      Material: Aluminum with Plastic Lens                      Finish: Silver</p>	<p><b>Description:</b> Wide optic for use in Elegance Mini Puck or Elegance Cylinder fixture. Reflector snaps into fixture head; remove using Reflector Tool below.</p>
CYLINDER SNOOT	SPECIFICATIONS	CAT. NO. ELL - AC - CY - SN -
	<p>Dimensions: Ø0.88" x 0.50" [Ø21.84mm x 12.7mm]                      Material: Aluminum                      Finish: Silver (AL) or Black (BL) Anodized</p>	<p><b>Description:</b> Description: Threaded snoot for use with Elegance Cylinder or Mini-Puck fixtures. Snoot screws in and extends fixture .50" [12.7mm] to provide glare shield; Wide Reflector must be removed before installing snoot. Silver (AL) or Black (BL) anodized finish.</p>
REFLECTOR TOOL	SPECIFICATIONS	CAT. NO. ELL - AC - R - RT
	<p>Dimensions:                      Material: Plastic handle, wire loop</p>	<p><b>Description:</b> For use with Elegance Cylinder or Elegance Mini Puck fixtures. Lasso tool loops around Reflector and tightens to pop Reflector accessory out of fixture. Can be used with 30°, 45° or 60° Reflector accessory.</p>
PUCK REMOVAL TOOL	SPECIFICATIONS	CAT. NO. ELL - AC - R - PRT
	<p>Dimensions: 5" [127mm] length                      Material: Plastic handle, steel hook</p>	<p><b>Description:</b> For use with Elegance Mini Puck fixtures; allows fully-recessed Mini Puck fixture to be removed after installation. Tool hooks into small hole in fixture provided for this purpose.</p>

AL  
BL

CONSTANT CURRENT WIRING ACCESSORIES 

CONNECTORS

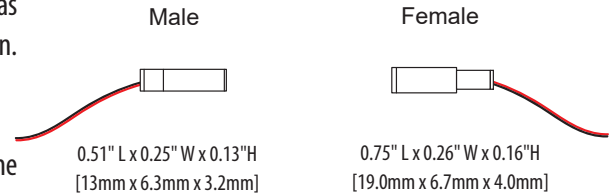
Fixtures come with 96" [2.44m] of 20 AWG wire and male JST Slim Seal connector as standard; customization available; connector can be removed for hard wired installation. Starter, splitter and interconnect wiring accessories for easy installation below.

Multiple constant current fixtures in the same circuit are wired in series, whereby the fixtures are connected along a single path, with the same current flowing through all fixtures. If there is a break in the circuit (i.e. an open connector), none of the LEDs will work.

When using a splitter to connect multiple constant current fixtures in the same circuit, EVERY connector must be mated with a fixture or with the terminator plug provided to avoid breaking the circuit. **Starter Cables** have bare wires on one end to connect directly to LED driver terminals or to wires via wire nuts, and one (1) female connector for connection to a fixture, splitter accessory, or interconnect wire.

**Splitters** connect multiple fixtures to a single driver; 2- way, 4-way or 8-way options; one (1) male connector, multiple female connectors.

**Interconnect Wires** extend wiring between driver and fixture or between splitter accessory and fixture; (1) one female connector, (1) one male connector.



All Wiring Accessories are UL Listed (UL 2108).

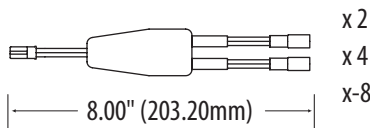
2 FT or 8 FT STARTER CABLE	SPECIFICATIONS	CAT. NO.	ELL - AC - CC - SC -
			2 8



**Description:** Bare wires and female connector. Bare wires connect to LED driver terminals or to wires via wire nuts; female connector connects directly to fixture, splitter or interconnect wire. 2' or 8' lengths, 20 AWG wire.



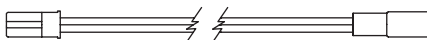
2, 4 or 8- WAY SPLITTER	SPECIFICATIONS	CAT. NO.	ELL - AC - CC - SPL -
			2 4 8



**Description:** One male connector with multiple female connectors. Allows 2, 4 or 8 fixtures to connect to a single driver; male connector connects to starter cable; female connectors connect to fixtures or interconnect wires. Overall length 8"; Each female connector 3" long. 20 AWG wire.



INTERCONNECT WIRES	SPECIFICATIONS	CAT. NO.	ELL - AC - CC - ICW -
			2 4 5 10



**Description:** One male and one female connector for extending connection between driver and fixture or between driver and splitter accessory. . 2', 4', 5' and 10' lengths, 20 AWG wire.



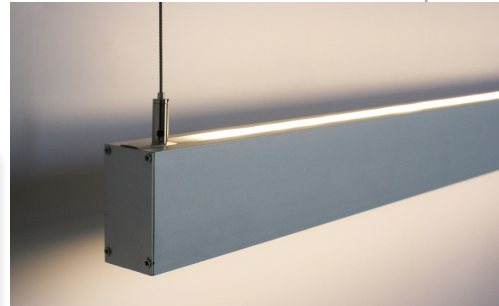
## SUSPENDED



SR2



SR3



SS2

**New!** SUSPENDED FIXTURE FUNDAMENTALS

All LEDs binned to within 3 MacAdam ellipses.

LENSING	Frosted Acrylic
FINISH	Silver, Black, Bronze or White Powder Coat, Custom Finishes on Request
LENGTHS	24" [609.6mm] up to 120" [3048mm]; See Length & Wattage Table for All Standard Length Options
ELECTRICAL	<b>Driver Type:</b> Integral Canopy Driver or Remote Driver; Constant Voltage, Class 2 UL Recognized <b>Input Voltage:</b> 120 - 240v 50/60hz <b>Dimming:</b> w/ Canopy Driver: ELV w/ Remote Driver: 0-10v, DALI, DMX, ELV <b>Operating Ambient Temperature:</b> -22° to 104° F [-30° to 40° C] <b>Humidity:</b> 90% RH Non-Condensing
LIFE & WARRANTY	50,000 HR Lifetime ( $T_a = -25^{\circ}\text{C}$ to $35^{\circ}\text{C}$ ; $T_c$ max $75^{\circ}\text{C}$ ); 5 Year Limited Warranty
MOUNTING	Suitable for Drywall Ceiling, Wood Ceiling or T-Bar Ceiling <b>For SS1, SS2 &amp; SR3:</b> Rincon® Powered Suspension System; 120" [3048mm] Standard Length <b>For SR2:</b> 0.062" Diameter Aircraft Cable in 120" Standard Length (Contact Factory for longer lengths)
LISTINGS & TESTS	cULus (UL 1598 & 2108); CE RoHS Compliant (if specified); LM79, LM80 ; IP20; Title 24 JA8-2016 <sup>1</sup> The EU's Restriction of Hazardous Substances Directive (RoHS) restricts the use of six hazardous substances* in electrical and electronic equipment (* Lead (Pb), Mercury, Cadmium, Hexavalent chromium, Polybrominated biphenyls and Polybrominated diphenyl ether (PBDE)). <sup>1</sup> Please contact factory for current list of JA8-2016 products.



**Suspended Linear Fixtures**, featuring four extrusion shapes and sizes. The **SS1** and **SR2** fixtures provide direct (down) illumination only, **SS2** and **SR3** fixtures can be specified to include both **direct** output along with **indirect ceiling wash**. All LED options are Pitchless LED Boards to insure full diffusion of diodes. LED options include Nichia LEDs in choice of 3 Hi CRI or Tunable White LED Boards.

Available in standard lengths from 24" [609.6mm] to 120" [3048mm] (contact factory for fixtures shorter than 24", custom lengths, or continuous runs).

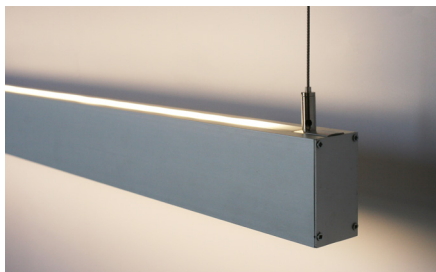
SS1, SS2 and SR3 are powered via Rincon® Powered Suspension System, suspended from Rectangular Canopy Boxes with integral driver, or via remote driver. SR2 fixtures are suspended via aircraft cable and powered through jacketed wire and remote driver.

Multiple finish options; canopy boxes with integral drivers in standard White finish or optional Chrome; 5" canopies in standard White finish only.

VLT reserves the right to change specifications without notice. Please visit [www.vltdcorp.com](http://www.vltdcorp.com) for current cut sheets.

FIXTURE SUSPENSION & POWER OPTIONS

SS1, SS2 and SR3 Fixtures are suspended and powered with **Rincon® Powered Suspension System**; SR2 Suspended Fixture powered via **Decorative Jacketed Wire** (White, Black, Grey or Custom color).



Powered Suspension System (SS1, SS2 & SR3)



Jacketed Wire Power Feed with Aircraft Cable (SR2 Only)

MADE IN USA

FIXTURE MOUNTING OPTIONS

Suspended Fixtures can be mounted from T-Bar, Dry Wall or Wood surfaces. A variety of accessory mounting kits are available for use with these surfaces; contact factory to determine the best options for your fixture and mounting surface.

## PITCHLESS HI CRI LED BOARDS 95+/ DUAL ROW

LED BOARD	3140D	3160D	3180D
LUMEN OUTPUT <sup>1</sup>	342 lm/ft [1122 lm/m]	670 lm/ft [2198 lm/m]	1075 lm/ft [3526 lm/m]
POWER CONSUMPTION	4.4 w/ft [14.4 w/m]	8.6 w/ft [28.2 w/m]	13.8 w/ft [45.2 w/m]
CRI	95+	95+	95+
CCT OPTIONS	2000K 2200K 4000K	2500K 2700K 4500K	3000K 3500K 5000K
APPLIED LED	Nichia 757g	Nichia 757g	Nichia 757g
LED EFFICACY <sup>1</sup>	151 lm/w	151 lm/w	151 lm/w

<sup>1</sup> Based on 3500K CCT with Lens

## PITCHLESS HI CRI LED BOARDS 95+/ SINGLE ROW

LED BOARD	3140	3160	3180
LUMEN OUTPUT <sup>1</sup>	230 lm/ft [754 lm/m]	443 lm/ft [1453 lm/m]	712 lm/ft [2335 lm/m]
POWER CONSUMPTION	2.2 w/ft [7.2 w/m]	4.3 w/ft [14.1 w/m]	6.9 w/ft [22.6 w/m]
CRI	95+	95+	95+
CCT OPTIONS	2000K 2200K 4000K	2500K 2700K 4500K	3000K 3500K 5000K
APPLIED LED	Nichia 757g	Nichia 757g	Nichia 757g
LED EFFICACY <sup>1</sup>	151 lm/w	151 lm/w	151 lm/w

## PITCHLESS TUNABLE WHITE

LED BOARD	7180D	7180
LUMEN OUTPUT <sup>2</sup>	1086 lm/ft [3562 lm/m]	715 lm/ft [2345 lm/m]
POWER CONSUMPTION	13.8 w/ft [45.2 w/m]	6.9 w/ft [22.6 w/m]
CRI	95+	95+
CCT OPTIONS	2000K/3000K 2500K/4000K	3000K/4000K 3500K/4500K
APPLIED LED	Nichia 757g	Nichia 757g
LED EFFICACY <sup>2</sup>	151 lm/ft	151 lm/w

<sup>2</sup> Based on 3500K/4500K CCT in SS2 with Lens

## LUMENS / FOOTCANDLES TABLE WITH FROSTED ACRYLIC LENS

	LED Board	Watts per Foot	Lumens per Foot	Footcandles at 12"
Pitchless Hi CRI LED Boards Dual Row	3140D	4.4 w/ft	342 lm/ft	TBD
	3160D	8.6 w/ft	670 lm/ft	TBD
	3180D	13.8 w/ft	1075 lm/ft	TBD
Tunable White Dual Row	7180D	13.8 w/ft	1086 lm/ft	TBD
Tunable White Single Row	7180	6.9 w/ft	715 lm/ft	TBD

(TBD: New fixture data not available at time of printing. Please check website at [www.vltd.com](http://www.vltd.com) for updates.)

**Pitchless:** "Pitch" is the spacing between LEDs on a circuit board; a "pitchless" board has no spacing between the LEDs, creating a bright board that fully diffuses the "dot" pattern of LED diodes in a short distance between board and lens. Pitchless LED boards fully diffuse when used in any **EssentialLEDs Suspended** fixture.

**Hi CRI LED** boards feature 757g LEDs with CRI of 95 or higher. Compliance with California's Title 24 JA8-2016 standard requires that new and remodel residential lighting applications must have a CRI of 90 or above and a Kelvin temperature (CCT) between 2700K and 4000K.

Tunable White LED Boards include discrete control of two different CCT's, allowing designers the ability to dial in to the perfect CCT, or the flexibility of changing CCT to set different scenes.

CCT	2000K	2200K	2500K	2700K	3000K	3500K	4000K	4500K	5000K
LIGHT OUTPUT CONVERSION	0.68	0.74	0.82	0.96	1.0	1.0	1.0	1.01	1.1



SS1 & SR2 FIXTURE LENGTH & WATTAGE

			SS1 Direct Lighting				SR2 Direct Lighting			
	Finished Fixture		3140D 4.4 w/ft	3160D 8.6 w/ft	3180D 13.8 w/ft	7180D 13.8 w/ft	3140 2.2 w/ft	3160 4.3 w/ft	3180 6.9 w/ft	7180 6.9 w/ft
24	23.66"	[601.0mm]	8.8 w	17.2 w	27.6 w	27.6 w <sup>1</sup>	4.4 w	8.6 w	13.8 w	13.8 w <sup>1</sup>
36	35.24"	[895.1mm]	13.2 w	25.8 w	41.4 w	41.4 w <sup>1</sup>	6.6 w	12.9 w	20.7 w	20.7 w <sup>1</sup>
48	46.82"	[1189.2mm]	17.6 w	34.4 w	55.2 w	55.2 w <sup>1</sup>	8.8 w	17.2 w	27.6 w	27.6 w <sup>1</sup>
60	58.40"	[1483.4mm]	22.0 w	43.0 w	69.0 w	69.0 w <sup>1</sup>	11.0 w	21.5 w	34.5 w	34.5 w <sup>1</sup>
72	69.98"	[1777.5mm]	26.4 w	51.6 w	82.8 w	82.8 w <sup>1</sup>	13.2 w	25.8 w	41.4 w	41.4 w <sup>1</sup>
84	81.56"	[2071.6mm]	30.8 w	60.2 w	96.6 w <sup>1</sup>	96.6 w <sup>1</sup>	15.4 w	30.1 w	48.3 w	48.3 w <sup>1</sup>
96	93.14"	[2366.0mm]	35.2 w	68.8 w	110.4 w <sup>1</sup>	110.4 w <sup>1</sup>	17.6 w	34.4 w	55.2 w	55.2 w <sup>1</sup>
108	104.72"	[2660.0mm]	39.6 w	77.4 w	124.2 w <sup>1</sup>	124.2 w <sup>1</sup>				
120	116.30"	[2954.0mm]	44.0 w	86.0 w	138.0 w <sup>1</sup>	138.0 w <sup>1</sup>				

SS2 & SR3 FIXTURE LENGTH & WATTAGE

			Direct Lighting				InDirect Lighting			
	Finished Fixture		3140D 4.4 w/ft	3160D 8.6 w/ft	3180D 13.8 w/ft	7180D 13.8 w/ft	3140 2.2 w/ft	3160 4.3 w/ft	3180 6.9 w/ft	7180 6.9 w/ft
24	23.66"	[601.0mm]	8.8 w	17.2 w	27.6 w	27.6 w <sup>1</sup>	3.7 w	7.2 w	11.5 w	11.5 w <sup>1</sup>
36	35.24"	[895.1mm]	13.2 w	25.8 w	41.4 w	41.4 w <sup>1</sup>	5.9 w	11.5 w	18.4 w	18.4 w <sup>1</sup>
48	46.82"	[1189.2mm]	17.6 w	34.4 w	55.2 w	55.2 w <sup>1</sup>	8.1 w	15.8 w	25.3 w	25.3 w <sup>1</sup>
60	58.40"	[1483.4mm]	22.0 w	43.0 w	69.0 w	69.0 w <sup>1</sup>	10.3 w	20.1 w	32.2 w	32.2 w <sup>1</sup>
72	69.98"	[1777.5mm]	26.4 w	51.6 w	82.8 w	82.8 w <sup>1</sup>	12.5 w	24.4 w	39.1 w	39.1 w <sup>1</sup>
84	81.56"	[2071.6mm]	30.8 w	60.2 w	96.6 w <sup>1</sup>	96.6 w <sup>1</sup>	14.7 w	28.7 w	46.0 w	46.0 w <sup>1</sup>
96	93.14"	[2366.0mm]	35.2 w	68.8 w	110.4 w <sup>1</sup>	110.4 w <sup>1</sup>	16.9 w	33.0 w	52.9 w	52.9 w <sup>1</sup>
108	104.72"	[2660.0mm]	39.6 w	77.4 w	124.2 w <sup>1</sup>	124.2 w <sup>1</sup>	19.1 w	37.3 w	59.8 w	59.8 w <sup>1</sup>
120	116.30"	[2954.0mm]	44.0 w	86.0 w	138.0 w <sup>1,2</sup>	138.0 w <sup>1,2</sup>	21.3 w	41.6 w	66.7 w <sup>2</sup>	66.7 w <sup>1,2</sup>

SS2 & SR3 DIRECT & INDIRECT COMBINED FIXTURE LENGTH & WATTAGE

			Combined Wattage			
Code	Finished Fixture		3140	3160	3180	7180
24	23.66"	[601.0mm]	12.5 w	24.4 w	39.1 w	39.1 w <sup>1</sup>
36	35.24"	[895.1mm]	19.1 w	37.3 w	59.8 w	59.8 w <sup>1</sup>
48	46.82"	[1189.2mm]	25.7 w	50.2 w	80.5 w	80.5 w <sup>1</sup>
60	58.40"	[1483.4mm]	32.3 w	63.1 w	101.2 w <sup>1</sup>	101.2 w <sup>1</sup>
72	69.98"	[1777.5mm]	38.9 w	76.0 w	121.9 w <sup>1</sup>	121.9 w <sup>1</sup>
84	81.56"	[2071.6mm]	45.5 w	88.9 w	142.6 w <sup>1</sup>	142.6 w <sup>1</sup>
96	93.14"	[2366.0mm]	52.1 w	101.8 w <sup>1</sup>	163.3 w <sup>1</sup>	163.3 w <sup>1</sup>
108	104.72"	[2660.0mm]	58.7 w	114.7 w <sup>1</sup>	184.0 w <sup>1</sup>	184.0 w <sup>1</sup>
120	116.30"	[2954.0mm]	65.3 w	127.6 w <sup>1</sup>		

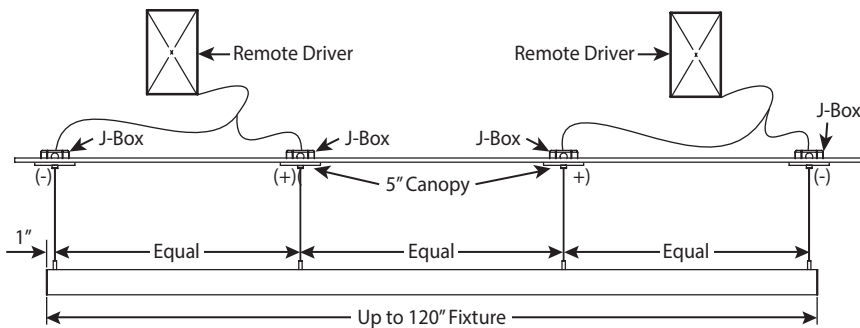
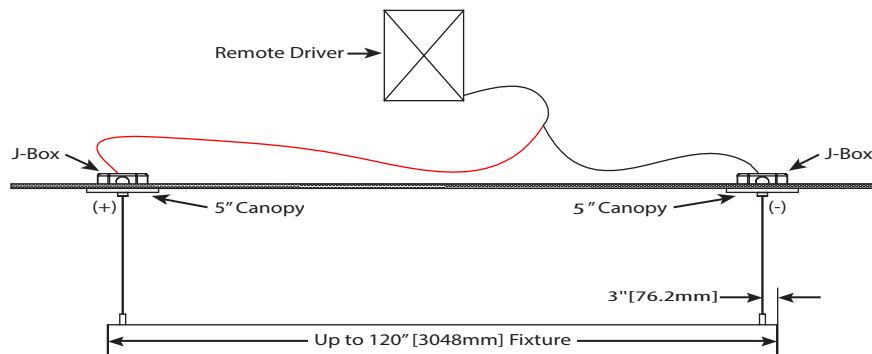
<sup>1</sup> Requires RD2, CMD2, EMD2A or EMD2B Driver Options

<sup>2</sup> Direct + Indirect combined wattage exceeds 2 driver maximum with this LED Board



## Remote Driver Mounting Options

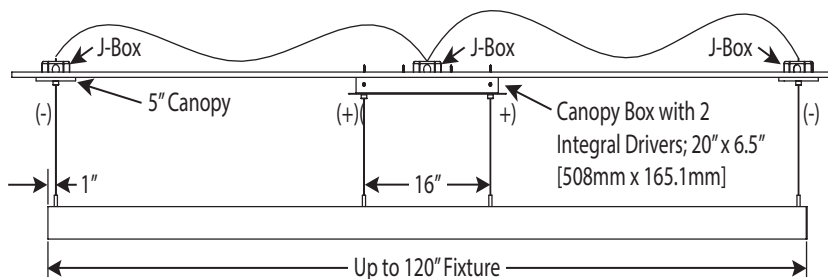
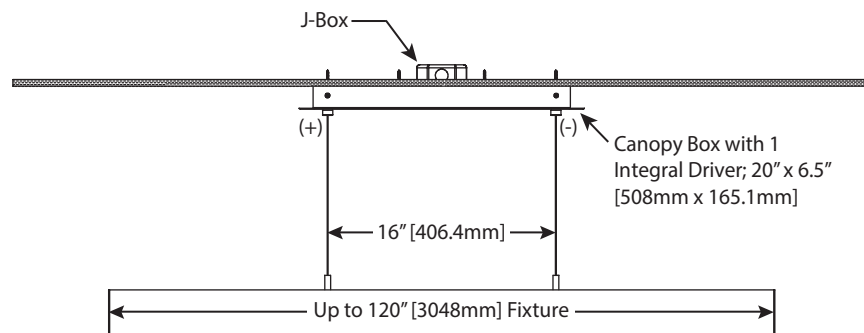
**(RD1)** Includes Two 5" Mounting Canopies in Standard White and Standard 120" [3048mm] Rincon Powered Suspension System Cables.<sup>1</sup> For use with Remote Driver.



**(RD2)** Includes Four 5" Mounting Canopies in Standard White and Standard 120" [3048mm] Rincon Powered Suspension System Cables.<sup>1</sup> For use with Remote Driver.

## Center Mount Canopy Driver Options

**(CMD1)** Fixture Suspended from 20" x 6.5" [508mm x 165.1mm] Canopy Box with Integral 96w Driver in Standard White or Optional Chrome Finish. Includes Standard 120" [3048mm] Rincon Powered Suspension Cables.<sup>1</sup>

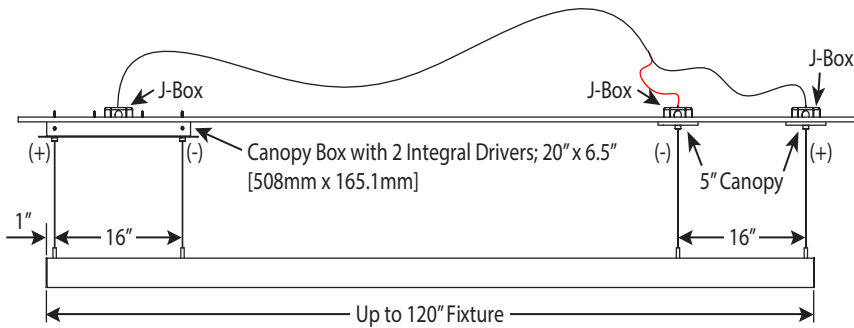
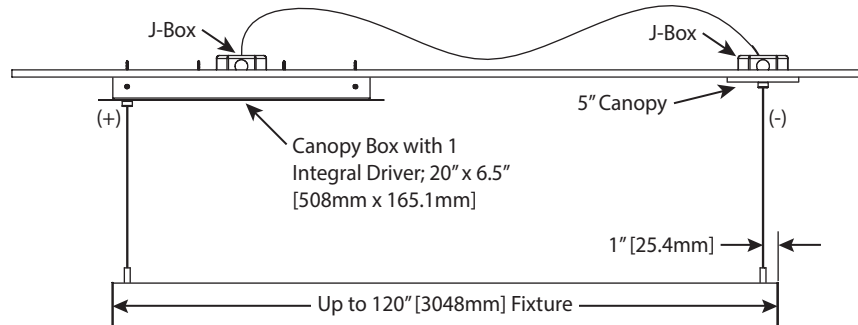


**(CMD2)** Fixture Suspended from 20" x 6.5" [508mm x 165.1mm] Canopy Box with Two Integral 96w Drivers and Two 5" Mounting Canopies. Standard White Finish for all Canopies. Canopy Box available in Optional Chrome Finish. Includes Standard 120" [3048mm] Rincon Powered Suspension Cables.<sup>1</sup>

<sup>1</sup> SR2 Fixture Replaces Rincon System with Non-Powered Suspension Cables and Separate, Jacketed Power Wire.

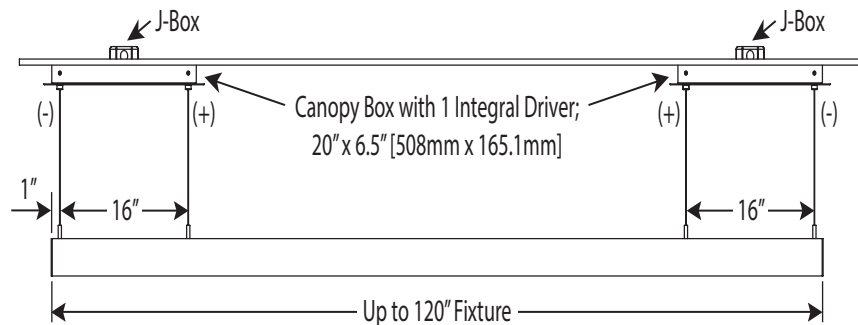
End Mount Canopy Driver Options

**(EMD1)** Fixture Suspended from 20" x 6.5" [508mm x 165.1mm] Canopy Box with Integral 96w Driver and One 5" Mounting Canopy. Standard White Finish for all Canopies. Canopy Box available in Optional Chrome Finish. Includes Standard 120" [3048mm] Rincon Powered Suspension Cables.<sup>1</sup>



**(EMD2A)** Fixture Suspended from 20" x 6.5" [508mm x 165.1mm] Canopy Box with Two Integral 96w Drivers and Two 5" Mounting Canopies. Standard White Finish for all Canopies. Canopy Box available in Optional Chrome Finish. Includes Standard 120" [3048mm] Rincon Powered Suspension Cables.<sup>1</sup>

**(EMD2B)** Fixture Suspended from Two 20" x 6.5" [508mm x 165.1mm] Canopy Boxes, each with Integral 96w Driver in Standard White or Optional Chrome Finish. Includes Standard 120" [3048mm] Rincon Powered Suspension Cables.<sup>1</sup>

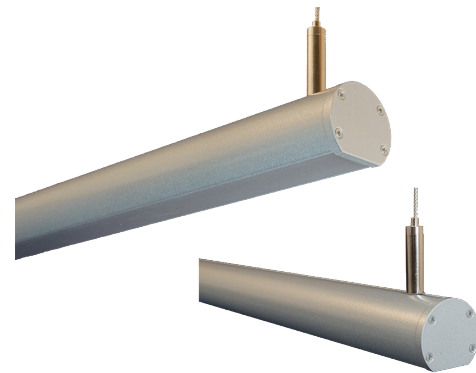


<sup>1</sup> SR2 Fixture Replaces Rincon System with Non-Powered Suspension Cables and Separate, Jacketed Power Wire.

**New!** SR2 MEDIUM ROUND PENDANT  
DIRECT ONLY

IP40 | Medium round extrusion (1.5" [38.1mm] Diameter) for suspended lighting fixtures with direct light output. All LED options are Pitchless LED boards for full diffusion of LED diodes. Includes Nichia LEDs in choice of 3 Hi CRI and 1 Tunable White LED Board options. All LEDs binned to within 3 MacAdam Ellipses. Silver, Black, Bronze, White or Custom Finishes; frosted acrylic lens (standard). Low voltage power feed via jacketed wire in matching color.<sup>1</sup> Suspended via non-powered aircraft cables in 10 ft [3048mm] standard length. UL Listed dry/damp. Photometrics vary based on LED board and CCT; Refer to Suspended Fixture Fundamentals for lumen outputs, CCTs, wattage and other data specific to your fixture choices.

<sup>1</sup> Bronze fixture uses Black jacketed wire.



ELS- SR2 -

LED	
3140	230 lm/ft, 2.2 w/ft, 95+ CRI
3160	443 lm/ft, 4.3 w/ft, 95+ CRI
3180	712 lm/ft, 6.9 w/ft, 95+ CRI
7180	715 lm/ft, 6.9 w/ft

HI CRI     Tunable White

CCT	
20	2000°K
22	2200°K
25	2500°K
27	2700°K
30	3000°K
35	3500°K
40	4000°K
45	4500°K
50	5000°K
20/30	2000°/3000°K
25/40	2500°/4000°K
30/40	3000°/4000°K
35/45	3500°/4500°K

Lens	
FR	Frosted Acrylic

Fixture Finish	
AL	Silver Powder Coat
BL	Black Powder Coat
BZ	Bronze Powder Coat
WH	White Powder Coat
C	Custom

Driver Options	
RD1	1 Remote Driver + 5" Canopies <sup>3</sup>
RD2	2 Remote Drivers + 5" Canopies <sup>3</sup>
CMD1	Center Mount Single Driver <sup>1</sup>
CMD2	Center Mount Dual Drivers + 5" Canopies <sup>2</sup>
EMD1	End Mount Single Driver + 5" Canopy <sup>1</sup>
EMD2A	End Mount Dual Drivers + 5" Canopies <sup>2</sup>
EMD2B	Dual End Mount Single Drivers <sup>2</sup>

<sup>1</sup> Includes 1 ELV Dimmable 96w Driver  
<sup>2</sup> Includes 2 ELV Dimmable 96w Drivers  
<sup>3</sup> Remote Driver Sold Separately

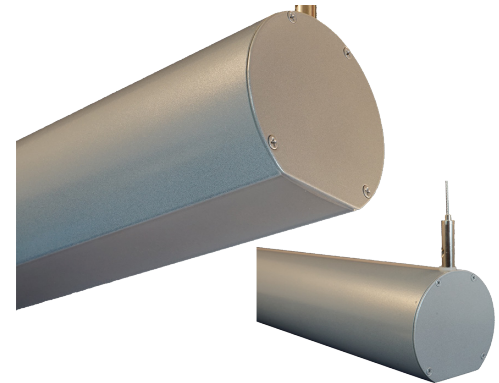
Listings & Options	
UL	UL Listed
CE	CE Marked (RoHS)
TBR	T-Bar Mount
DW	Drywall/Wood Mount
CH	Chrome Canopy Box

Fixture Length	
----------------	--

See Suspended Fixture Fundamentals. Choose the correct Code number for the LED board(s) and fixture length of your choice.

**New!** SR3 LARGE ROUND PENDANT  
DIRECT/INDIRECT

IP40 | Large round extrusion (3.4" [86.4mm] Diameter) for suspended lighting fixtures with direct/indirect light output. All LED options are Pitchless LED Boards for full diffusion of diodes. Includes Nichia LEDs in choice of 3 Hi CRI and 1 Tunable White LED Board options; all LEDs binned to within 3 MacAdam Ellipses. Silver, Black, Bronze, White or Custom Powder Coat Finishes; frosted acrylic lens (standard). Low voltage power feed via Rincon® Powered Suspension System; 10 ft. [3.48m] standard suspension cable length. UL Listed dry/damp. Photometrics vary based on LED board and CCT; Refer to Suspended Fixture Fundamentals for lumen outputs, CCTs, wattage and other data specific to your fixture choices.



SR3 can be specified with **DIRECT** (down) output only, or with **DIRECT/INDIRECT** (down+up) output.

ELS- SR3 - - - - - FR - - - - -

**DIRECT LED (DOWN)**

3140D	342 lm/ft, 4.4 w/ft, 95+ CRI
3160D	670 lm/ft, 8.6 w/ft, 95+ CRI
3180D	1075 lm/ft, 13.8 w/ft, 95+ CRI
7180D	1086 lm/ft, 13.8 w/ft

**INDIRECT LED (UP)**

3140	230 lm/ft, 2.2 w/ft, 95+ CRI
3160	443 lm/ft, 4.3 w/ft, 95+ CRI
3180	712 lm/ft, 6.9 w/ft, 95+ CRI
7180	715 lm/ft, 6.9 w/ft
NO	NO UP LED

■ HI CRI   ■ Tunable White

**CCT**

20	2000°K
22	2200°K
25	2500°K
27	2700°K
30	3000°K
35	3500°K
40	4000°K
45	4500°K
50	5000°K
20/30	2000°/3000°K
25/40	2500°/4000°K
30/40	3000°/4000°K
35/45	3500°/4500°K

**Fixture Finish**

AL	Silver Powder Coat
BL	Black Powder Coat
BZ	Bronze Powder Coat
WH	White Powder Coat
C	Custom

**Lens**

FR	Frosted Acrylic
----	-----------------

**Driver Options**

RD1	1 Remote Driver + 5" Canopies <sup>3</sup>
RD2	2 Remote Drivers + 5" Canopies <sup>3</sup>
CMD1	Center Mount Single Driver <sup>1</sup>
CMD2	Center Mount Dual Drivers + 5" Canopies <sup>2</sup>
EMD1	End Mount Single Driver + 5" Canopy <sup>1</sup>
EMD2A	End Mount Dual Drivers + 5" Canopies <sup>2</sup>
EMD2B	Dual End Mount Single Drivers <sup>2</sup>

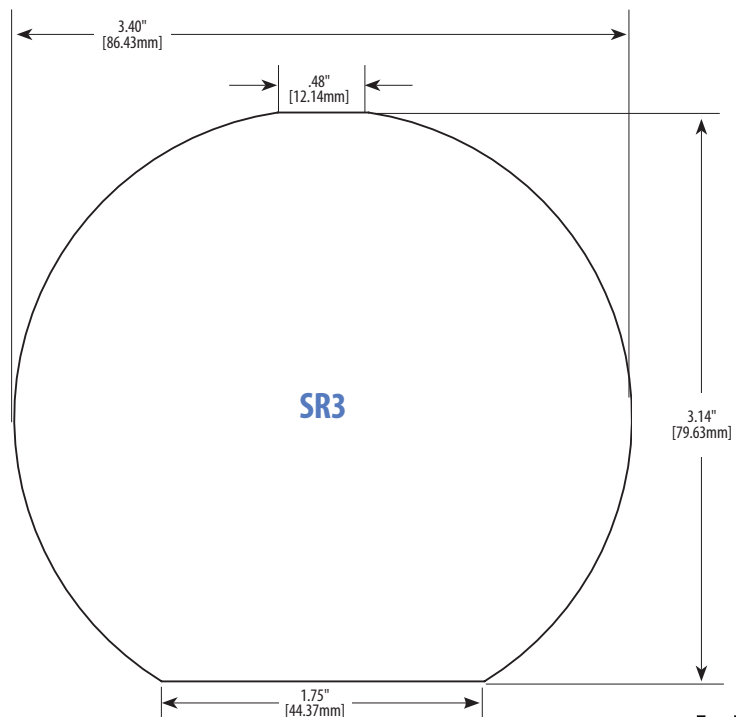
<sup>1</sup> Includes 1 ELV Dimmable 96w Driver  
<sup>2</sup> Includes 2 ELV Dimmable 96w Drivers  
<sup>3</sup> Remote Driver Sold Separately

**Listings & Options**

UL	UL Listed
CE	CE Marked (RoHS)
TBR	T-Bar Mount
DW	Drywall/Wood Mount
CH	Chrome Canopy Box

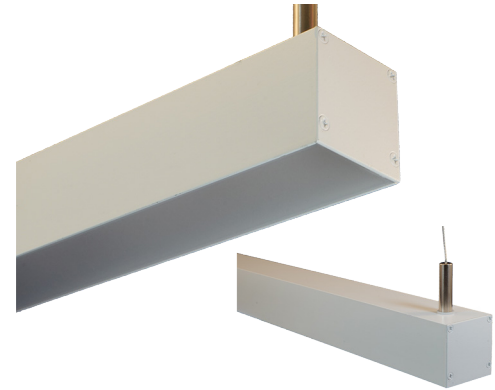
**Fixture Length**

See Suspended Fixture Fundamentals. Choose the correct Code number for the LED board(s) and fixture length of your choice.



**New!** SS1 SQUARE PENDANT  
DIRECT OR INDIRECT

IP40 | Square extrusion (1.85" x 1.85" [47mm x 47mm]) for suspended lighting fixtures with either direct light output or indirect light output. UL Listed dry/damp. Includes Nichia LEDs in choice of 3 Hi CRI and 1 Tunable White LED Board options; all LEDs binned to within 3 MacAdam Ellipses. Dual LED boards. Silver, Black, Bronze, White or Custom Finishes; frosted acrylic lens (standard). Low voltage power feed via Rincon® Powered Suspension System; 10 ft. [3048mm] standard length. Photometrics vary based on LED board and CCT; Refer to Suspended Fixture Fundamentals for lumen outputs, CCTs, wattage and other data specific to your fixture choices.



SS1 can be specified with **DIRECT** (pointing down) output only, or with **INDIRECT** (pointing up) output only.

ELS-SS1- \_\_\_\_\_ - \_\_\_\_\_ - \_\_\_\_\_ - \_\_\_\_\_ - FR - \_\_\_\_\_ - \_\_\_\_\_ - \_\_\_\_\_ - \_\_\_\_\_

Light Direction	
D	DIRECT (Down)
U	INDIRECT (Up)

CCT	
20	2000°K
22	2200°K
25	2500°K
27	2700°K
30	3000°K
35	3500°K
40	4000°K
45	4500°K
50	5000°K
20/30	2000°/3000°K
25/40	2500°/4000°K
30/40	3000°/4000°K
35/45	3500°/4500°K

LED	
3140D	342 lm/ft, 4.4 w/ft, 95+ CRI
3160D	670 lm/ft, 8.6 w/ft, 95+ CRI
3180D	1075 lm/ft, 13.8 w/ft, 95+ CRI
7180D	1086 lm/ft, 13.8 w/ft

Fixture Finish	
AL	Silver Powder Coat
BL	Black Powder Coat
BZ	Bronze Powder Coat
WH	White Powder Coat
C	Custom

Lens	
FR	Frosted Acrylic

Driver Options	
RD1	1 Remote Driver + 5" Canopies <sup>3</sup>
RD2	2 Remote Drivers + 5" Canopies <sup>3</sup>
CMD1	Center Mount Single Driver <sup>1</sup>
CMD2	Center Mount Dual Drivers + 5" Canopies <sup>2</sup>
EMD1	End Mount Single Driver + 5" Canopy <sup>1</sup>
EMD2A	End Mount Dual Drivers + 5" Canopies <sup>2</sup>
EMD2B	Dual End Mount Single Drivers <sup>2</sup>

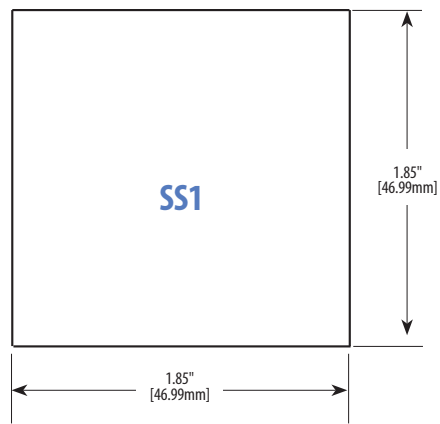
Listings & Options	
UL	UL Listed
CE	CE Marked (RoHS)
TBR	T-Bar Mount
DW	Drywall Mount
CH	Chrome Canopy Box

**Fixture Length**

See Suspended Fixture Fundamentals. Choose the correct Code number for the LED board(s) and fixture length of your choice.

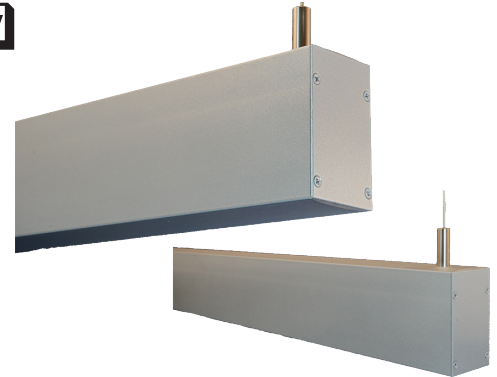
■ HI CRI    ■ Dual Hi CRI

<sup>1</sup> Includes 1 ELV Dimmable 96w Driver  
<sup>2</sup> Includes 2 ELV Dimmable 96w Drivers  
<sup>3</sup> Remote Driver Sold Separately



**New!** SS2 RECTANGULAR PENDANT  
DIRECT/INDIRECT

IP40 | Large rectangular extrusion (1.85" x 3.0" [47mm x 76.2mm]) for suspended lighting fixtures with direct/indirect light output. All LED options are Pitchless LED Boards for full diffusion of diodes. Includes Nichia LEDs in choice of 3 Hi CRI and 1 Tunable White LED Board options; all LEDs binned to within 3 MacAdam Ellipses. Silver, Black, Bronze, White or Custom Finishes; frosted acrylic lens (standard). Low voltage power feed via Rincon® Powered Suspension System; 10 ft. [3048mm] standard suspension cable length. UL Listed dry/damp. Photometrics vary based on LED board and CCT; Refer to Suspended Fixture Fundamentals for lumen outputs, CCTs, wattage and other data specific to your fixture choices.



SS2 can be specified with **DIRECT** (down) output only, or with **DIRECT/INDIRECT** (down+up) output.

ELS-SS2 - - - - - FR - - - - -

**DIRECT LED (DOWN)**

3140D	342 lm/ft, 4.4 w/ft, 95+ CRI
3160D	670 lm/ft, 8.6 w/ft, 95+ CRI
3180D	1075 lm/ft, 13.8 w/ft, 95+ CRI
7180D	1086 lm/ft, 13.8 w/ft

**Fixture Finish**

AL	Silver Powder Coat
BL	Black Powder Coat
BZ	Bronze Powder Coat
WH	White Powder Coat
C	Custom

**Lens**

FR	Frosted Acrylic
----	-----------------

**Listings & Options**

UL	UL Listed	UL US
CE	CE Marked (RoHS)	CE
TBR	T-Bar Mount	
DW	Drywall/Wood Mount	
CH	Chrome Canopy Box	

**INDIRECT LED (UP)**

3140	230 lm/ft, 2.2 w/ft, 95+ CRI
3160	443 lm/ft, 4.3 w/ft, 95+ CRI
3180	712 lm/ft, 6.9 w/ft, 95+ CRI
7180	715 lm/ft, 6.9 w/ft
NO	NO UP LED

**CCT**

20	2000°K
22	2200°K
25	2500°K
27	2700°K
30	3000°K
35	3500°K
40	4000°K
45	4500°K
50	5000°K
20/30	2000°/3000°K
25/40	2500°/4000°K
30/40	3000°/4000°K
35/45	3500°/4500°K

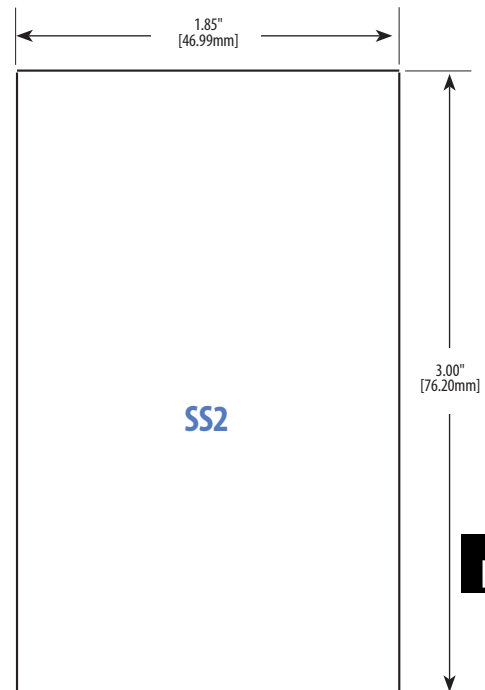
**Driver Options**

RD1	1 Remote Driver + 5" Canopies <sup>3</sup>
RD2	2 Remote Drivers + 5" Canopies <sup>3</sup>
CMD1	Center Mount Single Driver <sup>1</sup>
CMD2	Center Mount Dual Drivers + 5" Canopies <sup>2</sup>
EMD1	End Mount Single Driver + 5" Canopy <sup>1</sup>
EMD2A	End Mount Dual Drivers + 5" Canopies <sup>2</sup>
EMD2B	Dual End Mount Single Drivers <sup>2</sup>

<sup>1</sup> Includes 1 ELV Dimmable 96w Driver  
<sup>2</sup> Includes 2 ELV Dimmable 96w Drivers  
<sup>3</sup> Remote Driver Sold Separately

**Fixture Length**

See Suspended Fixture Fundamentals. Choose the correct Code number for the LED board(s) and fixture length of your choice.



■ HI CRI   ■ Tunable White





## LED LIGHT PANEL

Backlighting for Translucent Materials  
& Stretched Fabric Ceilings

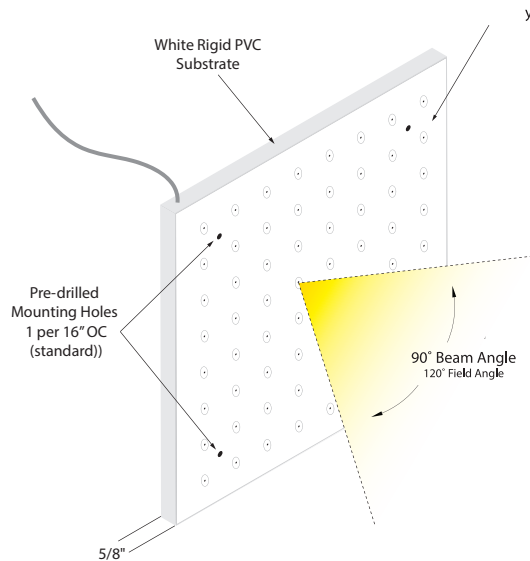


Product: ELP-L, ELP-L  
ELP-G, ELP-L



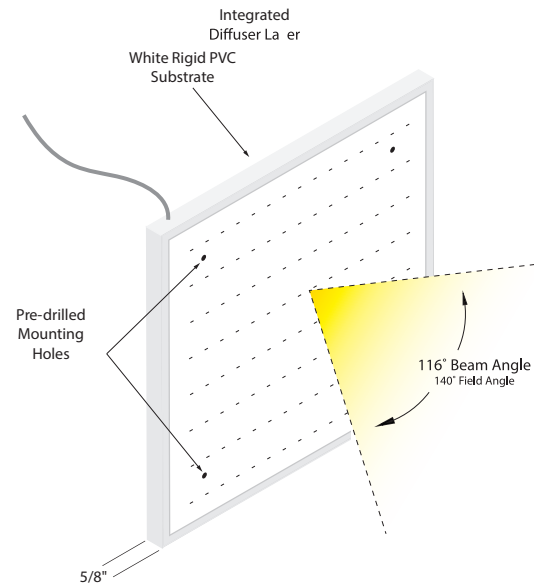
## ABOUT LIGHT PANEL

EssentialLEDs® Light Panel is a highly customizable lighting product that is ideal for backlighting materials like Acrylic Panels, Frosted Glass, Onyx or Stretched Fabric. We offer two versions of Light Panel, as described below:



### ELP - L

**ELP-L** is the most popular version of EssentialLEDs® Light Panel because of its versatility in customization and lower cost. ELP-L offers two wattage/lumen options, variable spacing options, and nine CCT options in addition to variable color temperature mixing (two different CCTs with separate dimming control). ELP-L can be combined with T-Bar or suspension hardware for use as a general lighting source, and can also be used as a light source in custom-designed fixtures.



### ELP - G

**ELP-G** is a specialized version of EssentialLEDs® Light Panel, developed specifically for backlighting stretched fabric ceiling installations. ELP-G features LEDs arranged on a 1" x 1" (nominal) grid, with an onboard regulated power supply that allows it to produce the very high fixture efficacy level of 140 lumens per watt. ELP-G is available in nine CCT options, and can backlight translucent fabric ceilings with zero lamp imaging hot spots in a mere five inches of throw distance.

Both ELP-L and ELP-G consist of LED modules placed on a lightweight expanded PVC substrate, and both can be fabricated in custom shapes and sizes up to 60" x 120" in a single panel. ELP-G can also be purchased as individual modules for installation in niches or millwork.

## ABOUT THE LEDs

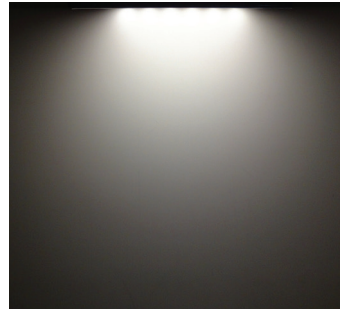
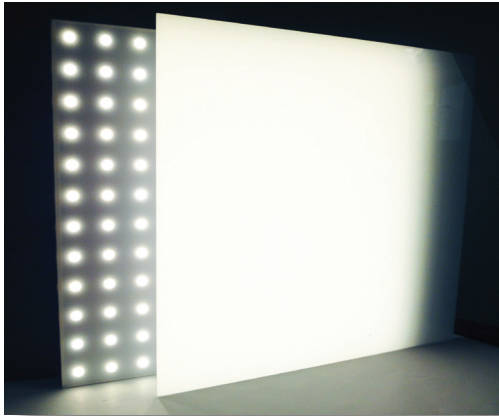
From the beginning, Visual Lighting Technologies has been proud to use LEDs from the Nichia Corporation as our applied LED. As one of the world's leading LED manufacturers, Nichia has leveraged its vast experience with phosphors to create beautiful white light LEDs in a full range of color temperatures. You can learn all about our very selective LED binning process in the "Binning and Chromaticity" section.



Both Panel Types Ship with Stickers That Clearly Mark Mounting Holes

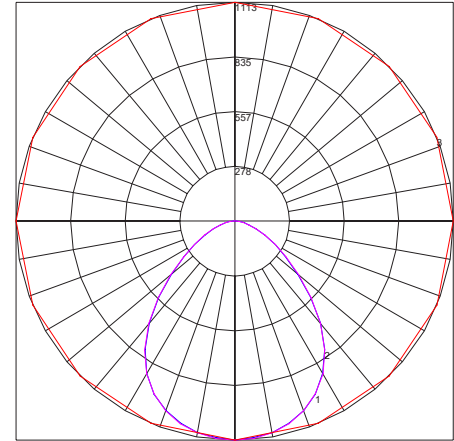
## LIGHT PANEL PHOTOMETRICS

### ELP - L



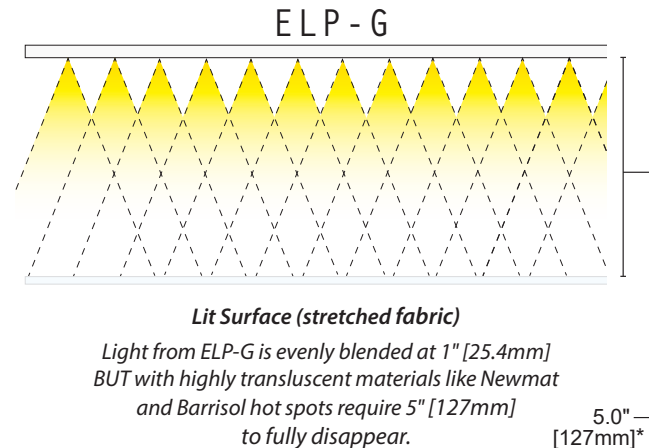
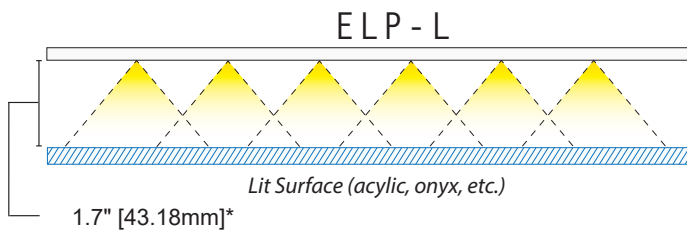
Pictured: 6 LED x 6 LED grid

Throw Distance	Average Foot Candles
1 ft.	1113
2 ft.	278
3 ft.	124
4 ft.	70



Maximum Candela = 1113 Located At Horizontal Angle = 0, Vertical Angle = 0  
 # 1 - Vertical Plane Through Horizontal Angles (0 - 180) (Through Max. Cd.) : BLUE  
 # 2 - Vertical Plane Through Horizontal Angles (45 - 225) : MAGENTA  
 # 3 - Horizontal Cone Through Vertical Angle (0) (Through Max. Cd.) : RED

## THROW DISTANCES



**ELP-L** is the perfect choice for backlighting materials like **acrylic** and **onyx**. Standard ELP-L includes an integrated diffuser and requires only 1.7" of cavity space for the LED diode light points to fully blend. Where cavity space is less than 1.7", use of a secondary diffuser (i.e. opal acrylic) may enable full diffusion in less than 1.7".

**When backlighting materials like 3form, stained or frosted glass**, use of a secondary diffuser (i.e. opal acrylic) will allow even backlighting without visible hot spots. A mock-up using proposed materials is always recommended.

Due to the **highly translucent** nature of materials like Newmat and Barrisol stretched fabric ceilings, full diffusion of the backlighting source becomes more difficult. ELP-G, with its 1"x1" LED spacing and exposed LED board construction, can provide full diffusion without "hot spots" in just 5" of cavity space (as compared to a range of 12" to 16" with fluorescent lamps). See page 99 for more information regarding stretched fabric ceilings.

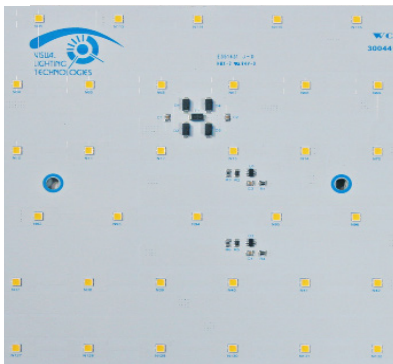
Where cavity space is extremely limited, materials like acrylic and onyx can also be evenly backlit with ELP-G in just 1" of cavity space.

\*Dimension appropriate for most applications.  
 Mock-up recommended to determine optimum distance.

## BACKLIGHTING STRETCHED FABRIC CEILINGS

Stylish and versatile stretched fabric ceilings - such as those manufactured by Newmat or Barrisol - are popular for a wide range of commercial, retail, hospitality and residential applications. ELP-G Light Panel was **designed and engineered specifically** to provide a superior result when backlighting these stretched fabric ceilings. A regulated on-board power supply on each individual ELP-G LED board allows the product to achieve a **very high efficiency level of 140 lumens per watt** (560 lumens per square foot), and the result is bright and even backlighting without the unattractive lamp imaging that often occurs with fluorescent light sources. ELP-G offers distinct advantages over fluorescent lamp backlighting:

- **Cavity Depth:** ELP-G requires only 5" of separation between the LED panel and the stretched fabric to attain perfect diffusion\*, in contrast to the 12" - 16" needed with fluorescent lamps. So even where plenum spaces are very limited, low profile ELP-G modules will provide completely diffuse light with zero lamp imaging. (\*Smaller cavity may be possible. Must be determined with a mock-up).
- **Edge-to-Edge Lighting:** ELP-G panels screw directly to the installation surface using pre-drilled through-holes, and the range of ELP-G module sizes makes it possible to fully cover the ceiling surface - evenly and all the way to the edges - for beautiful backlighting without dark spots or edges.
- **Life Span & Maintenance:** On average, LEDs are rated to last three to four times longer than standard T8 fluorescent lamps (100,000 hours vs 15,000 hours), a significant difference when dealing with the complexities of stretched fabric ceilings. Relamping behind stretched fabric panels requires that the ceiling be fully removed and then re-installed by the manufacturer - a factor that lengthens the task, complicates scheduling, and adds to the cost of lamp maintenance. And when you consider the environmental issues of spent fluorescent lamps - the glass and mercury content and cost of safe (and legal) disposal, the longer lifespan of the LED alternative is even more attractive.
- **Quality of Light:** The small LEDs used in ELP-G provide excellent lumen output (560 lm/sq.ft., based on 4000K), with a full range of color temperatures and high CRI (83). Whether you're lighting a warm residential interior or cool commercial spaces, ELP-G will provide the perfect CCT. And the small light points, with their 116° beam angles, provide an exceptionally even backlight.
- **Light Quality Over Time:** Long before fluorescent lamps quit, they color-shift in different - and irregular - directions. Loss of mercury inside the lamp causes a shift to pink, often accompanied by black burns on the lamp ends and flickering. These issues are magnified by a stretched fabric application, where such irregularities are highly visible. In contrast, ELP-G delivers even lighting in very specific color temperatures that will remain constant over the much longer life of the product. Even as the product nears the end of its projected 100,000hr (LM80) lifespan, color temperature shift is minimal.



1" x 1" (nominal) spacing provides exceptionally even backlighting.

**Dimming ELP-G:** Stretched fabric ceilings often require a large number of drivers, and our new LED Driver Power Panels were developed with large installations like this in mind. UL Listed Power Panels can accommodate up to 14 constant voltage drivers in a tidy, wall-mount enclosure, with a single line voltage input, up to 14 outputs, and easy connection to multiple dimming control protocols (DMX, DALI, 0-10v). We also offer individual constant voltage drivers dimmable via MLV, ELV, 0-10V, DALI or DMX.

**Integrated Solution:** Visual Lighting Technologies can provide a complete, **turnkey backlit fabric ceiling**, featuring beautiful ELP-G backlighting and a fully customized stretched fabric ceiling installation. We can fully coordinate design and installation of both lighting and ceiling for spectacular results.

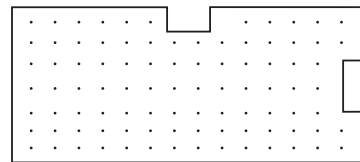
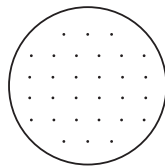
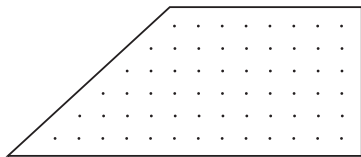
### ELP-L COLOR TUNING

Selection of any of the dual-color LED combinations (25K/45K, 30K/45K or 35K/45K) will allow the color temperature of the installation to be adjusted between the low Kelvin and high Kelvin temperatures. CCT adjustment is accomplished by alternately dimming or increasing output from the low Kelvin and high Kelvin diodes. Lumen outputs cited in product specifications are for a single set of diodes; if both sets of diodes are at full strength, lumen output and wattage are doubled. Color-tuning controls make CCT transitions easy and smooth, and also allow smooth dimming down to zero.

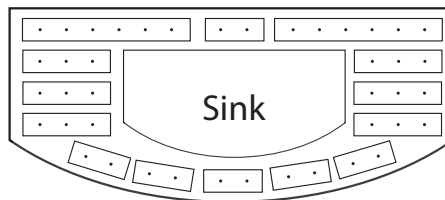


### PANEL SHAPE & SIZE OPTIONS

Whether you specify ELP-L or ELP-G, panel shapes are not limited to squares and rectangles. Shapes such as the ones pictured below are easy to make and require only a dimensioned sketch of the shape you need. VLT engineers will determine the optimum module placement to provide the most even results. Shapes can be any size within the 60" x 120" [1524mm x 3048mm] maximum. Order sizes carefully - panels cannot be trimmed in the field.



*To evenly backlight unusual shapes, LED Boards are arranged in custom configurations*






Notes: \_\_\_\_\_  
\_\_\_\_\_  
\_\_\_\_\_  
\_\_\_\_\_  
\_\_\_\_\_  
\_\_\_\_\_  
\_\_\_\_\_  
\_\_\_\_\_  
\_\_\_\_\_  
\_\_\_\_\_  
\_\_\_\_\_  
\_\_\_\_\_  
\_\_\_\_\_  
\_\_\_\_\_  
\_\_\_\_\_  
\_\_\_\_\_  
\_\_\_\_\_  
\_\_\_\_\_  
\_\_\_\_\_  
\_\_\_\_\_  
\_\_\_\_\_  
\_\_\_\_\_  
\_\_\_\_\_  
\_\_\_\_\_  
\_\_\_\_\_  
\_\_\_\_\_  
\_\_\_\_\_  
\_\_\_\_\_  
\_\_\_\_\_  
\_\_\_\_\_  
\_\_\_\_\_  
\_\_\_\_\_  
\_\_\_\_\_  
\_\_\_\_\_  
\_\_\_\_\_  
\_\_\_\_\_  
\_\_\_\_\_  
\_\_\_\_\_  
\_\_\_\_\_





## ELP-L LIGHT PANEL SPECIFICATIONS

LED BASICS	LED Board	Power Consumption	Lumen Output	LED Efficacy	CRI	CCT Tolerance					
	3727	6.0 w/sq. ft. [64.6w/sq. m]	595 lm/sq. ft. <sup>1</sup> [6405 lm/sq. m]	176 lm/w	95+	All LEDs binned to within 2 MacAdam Ellipse CCT tolerance of ± 60°K					
	3718	4.1 w/sq. ft. [44.1w/sq. m]	410 lm/sq. ft. <sup>1</sup> [4413 lm/sq. m]	176 lm/w	95+	All LEDs binned to within 2 MacAdam Ellipse CCT tolerance of ± 60°K					
	3709	2.1 w/sq. ft. [22.6w/sq. m]	205 lm/sq. ft. <sup>1</sup> [2206 lm/sq. m]	176 lm/w	95+	All LEDs binned to within 2 MacAdam Ellipse CCT tolerance of ± 60°K					
	2727	5.95 w/sq. ft. [64.0w/sq. m]	600 lm/sq. ft. <sup>1</sup> [6458 lm/sq. m]	176 lm/w	83	All LEDs binned to within 2 MacAdam Ellipse CCT tolerance of ± 60°K					
	2718	4.0 w/sq. ft. [43.0w/sq. m]	420 lm/sq. ft. <sup>1</sup> [4521 lm/sq. m]	176 lm/w	83	All LEDs binned to within 2 MacAdam Ellipse CCT tolerance of ± 60°K					
	2709	2.1 w/sq. ft. [22.6w/sq. m]	220 lm/sq. ft. <sup>1</sup> [2368 lm/sq. m]	176 lm/w	83	All LEDs binned to within 2 MacAdam Ellipse CCT tolerance of ± 60°K					
<sup>1</sup> Based on 3500K Color Temperature											
OPTICAL	<b>CCT:</b>	2000K	2200K	2500K	2700K	3000K	3500K	4000K	4500K	5000K	
	<b>Lumen Output:</b> <sup>2</sup> (2' x 2' Panel) <sup>2</sup>	1618 lm	1761 lm	1951 lm	2284 lm	2380 lm	2380 lm	2380 lm	2404 lm	2618 lm	
	<sup>2</sup> Based on 2727 LED Board Only										
	<b>Lumen Output Conversion:</b>	0.68	0.74	0.82	0.96	1.0	1.0	1.0	1.01	1.1	
	<b>Beam Angle/Field Angle:</b>	90° Beam Angle/120° Field Angle									
EFFICACY	<b>CRI:</b>	83 (Standard) or 95+ (HI CRI)									
	<b>CCT Tolerance:</b>	2 MacAdam Ellipse ± 60K									
	<b>LED Efficacy:</b>	176 lm/w (Based on 3500K CCT)									
<b>Fixture Efficacy:</b>	100 lm/w										
<b>Luminaire Efficacy:</b>	90 lm/w										
MECHANICAL	<b>Size Options:</b>	Min: 1.7" x 12" [43.18mm x 304.8mm]				Max: 60" x 120" [1524mm x 3048mm]					
	<b>LED Spacing:</b>	Standard - 1.7" x 1.7" [43.18mm x 43.18mm]									
	<b>Panel Thickness:</b>	5/8" Standard [15.5mm] (UL Only)					3/8" Compact [9.5mm] (UL + CE)				
	<b>Material:</b>	Expanded PVC - White or Custom Colors with Frosted Acrylic Lens Cover					ABS Plastic - White or Custom Colors with Frosted Acrylic Lens Cover				
	<b>Operating Ambient Temp.:</b>	-22° to 104° F			[-30° to 40° C]						
	<b>Humidity:</b>	90% RH Non-Condensing									
	<b>Weight:</b>	3.25 lbs./sq. ft. [15.9 k/sq. m] (Standard Thickness)									
	<b>Mounting:</b>	Through Bolt in Pre-drilled Holes, T-Bar, Aircraft Cable									
<b>Diffusion:</b>	Integrated Polycarbonate Layer, Optional Stand-off Diffuser										
ELECTRICAL	<b>Driver Type:</b>	Constant Voltage, Class 2 UL Listed									
	<b>Input Voltage:</b>	24V DC									
	<b>Applied LED:</b>	Nichia 757g									
	<b>Power Consumption:</b>	Up to 6.0 w/sq. ft. [64.6 w/sq. m]									
	<b>Dimming:</b>	MLV, ELV, 0-10V, DALI, DMX									
	<b>Max Wattage per Tail:</b>	96w									
	<b>Feed Wire:</b>	96" [2.44m] of Non Plenum-Rated, 16 AWG Wire [1.29mm] No Connector; Plenum-Rated Wiring Optional									
LISTINGS	 UL 2108 & 8750;  Marked; RoHs Compliant (if specified); LM79, LM80; UL Listed Dry/Damp										
	The EU's Restriction of Hazardous Substances Directive (RoHS) restricts the use of six hazardous substances* in electrical and electronic equipment (* Lead (Pb), Mercury, Cadmium, Hexavalent chromium, Polybrominated biphenyls and Polybrominated diphenyl ether (PBDE)).										
LIFE & WARRANTY	100,000 HR lifetime (T <sub>a</sub> = -25°C to 40°C; T <sub>c</sub> max 75°C); 5 year limited warranty										

## ELP-L LIGHT PANEL

EssentialLEDs® **ELP-L Light Panel** is the ideal product for backlighting materials such as Acrylic, Frosted Glass or Onyx, and for Stretched Fabric Ceilings where the plenum space exceeds 5".

**ELP-L** can be fabricated in any custom shape or size, with three different lumen/wattage options, in Standard (83 CRI) or Hi-CRI (95+ CRI). Available in nine single-color CCTs (2000K, 2200K, 2500K, 2700K, 3000K, 3500K, 4000K, 4500K and 5000K) and three dual-color options (2500K/4500K, 3000K/4500K, 3500K/4500K). Dual color can create variable mood environments by adjusting color temperature (also known as "color tuning"); new control options enable gradual CCT transitions along with smooth dimming down to zero.

Dual Color panels are built with two sets of LEDs - one of each CCT at each light point. The CCT of the light output is shifted by alternately dimming or increasing the power to the two sets of LEDs. The lumen outputs and wattage listed above apply to one set of LEDs only; with both sets of LEDs at full brightness, lumen output and wattage would be doubled.

Visit the VLT website for application photos & most recent IES files, LM79 & LM80 reports.

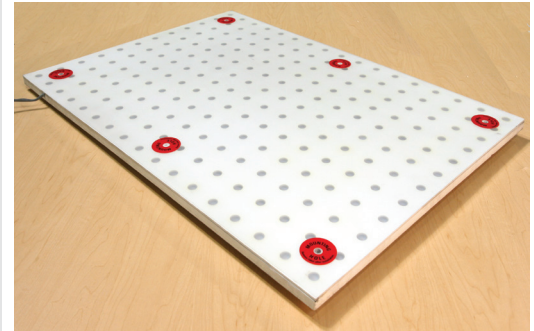
MADE IN USA 



ELP-L LIGHT PANEL

IP20 | This highly customizable product is ideal for backlighting applications (UL Listed dry/damp). Features Nichia LEDs with either Standard 27xx (83 CRI) or HI CRI 37xx (95+ CRI) in Wattages from 2.0 w/sq. ft. to 6.0 w/sq. ft. and Outputs from 205 lm/sq. ft. to 600 lm/sq. ft. LEDs are arranged in a 1.7" x 1.7" [17.78mm x 17.78mm] grid with one pre-drilled mounting hole every 16" [406.4mm] on center. Standard finished thickness is 5/8" [15.9mm]. Available color temperatures of 2000K, 2200K, 2500K, 2700K, 3000K, 3500K, 4000K, 4500K and 5000K. All LEDs binned to within 2 MacAdam Ellipse CCT tolerance of ± 60°K.

To order standard shapes (squares, rectangles) and standard LED placements, use the configurator below. For custom shapes, custom LED placements, or custom mounting hole placements, please contact the VLT factory.



Note: Square or rectangular panels sizes should be rounded down to the closest even multiple of 1.7" (for example, 23.8" instead of 24"). Additional fractions will not add LEDs or lumen output to the panel. ELP-L panels cannot be field cut to adjust fit, so rounding down the overall size of the panels can provide valuable "wiggle room" at installation sites where real world construction is not as exact as the original drawing.


ELP - L -

LED		CCT		Panel Width (in.)	Options & Accessories
3727	595 lm/sq.ft, 6.0 w/sq. ft, 95+ CRI	20	2000°K	Up to 60" [3048mm]	UL UL Listed
3718	410 lm/sq.ft, 4.1 w/sq. ft, 95+ CRI	22	2200°K	Panel Height (in.) Up to 120" [1524mm]	CE CE Marked (RoHS)
3709	205 lm/sq.ft, 2.1 w/sq. ft, 95+ CRI	25	2500°K		CP 3/8" [9.5mm] Compact Substrate <sup>1</sup> (instead of standard 5/8" [15.9mm])
2727	600 lm/sq. ft, 5.95 w/sq. ft, 83 CRI	27	2700°K	Wire Length (in.)	WE Wire Exit Location (WE2 standard)
2718	420 lm/sq. ft, 4.0 w/sq. ft, 83 CRI	30	3000°K	96" [2.44m] Standard (Option up to 30' [9.14m])	PR Plenum-Rated Wiring
2709	220 lm/sq. ft, 2.1 w/sq. ft, 83 CRI	35	3500°K	LED Spacing	DF Diffuser Panel
		40	4000°K		F 1.7" x 1.7" [43.2mm x 43.2mm]
		45	4500°K		SO Stand-offs (for mounting of both Light Panel and diffuser panel)
		50	5000°K		SG Suspension Grips (hardware for suspended applications)
		25/45	2500°K / 4500°K		AF Aluminum Framing (adds rigidity for larger panels)
		30/45	3000°K / 4500°K		
		35/45	3500°K / 4500°K		

Standard HI CRI

<sup>1</sup> Available only for wall-mount applications in sizes less than 24" x 24" [609.6mm x 609.6mm]

## ELP-G LIGHT PANEL SPECIFICATIONS

LED BASICS	LED Board	Power Consumption	Lumen Output	LED Efficacy	CRI	CCT Tolerance					
	1704	4.0 w/sq. ft <sup>1</sup> [43.0w/sq. m]	560 lm/sq. ft <sup>2</sup> [6025 lm/sq. m]	176 lm/w	83	All LEDs Binned to within 2 MacAdam Ellipse CCT tolerance of ± 60°K					
<sup>1</sup> Does not include driver losses		<sup>2</sup> Based on 3500K Color Temperature									
OPTICAL	<b>CCT:</b>	2000K	2200K	2500K	2700K	3000K	3500K	4000K	4500K	5000K	
	<b>Lumen Output:*</b> (2' x 2' Panel)*	1523 lm	1657 lm	1836 lm	2150 lm	2240 lm	2240 lm	2240 lm	2262 lm	2464 lm	
	<b>Lumen Output Conversion:</b>	0.68	0.74	0.82	0.96	1.0	1.0	1.0	1.01	1.1	
	<b>Beam Angle/Field Angle:</b>	116° Beam Angle/140° Field Angle									
	<b>CRI:</b>	83									
EFFICACY	<b>LED Efficacy:</b>	176 lm/w (Based on 4000K CCT)									
	<b>Fixture Efficacy:</b>	140 lm/w									
	<b>Luminaire Efficacy:</b>	130 lm/w									
MECHANICAL	<b>Size Options:</b>	Min: 3" x 3" [46.2mm x 76.2mm]				Max: 60" x 120" [1524mm x 3048mm]					
	<b>LED Spacing:</b>	1" x 1" [25.4mm x 25.4mm] (nominal)									
	<b>Panel Thickness:</b>	5/8" Standard [15.5mm] (UL Only)									
	<b>Material:</b>	Expanded PVC - White or Custom Colors with Clear Acrylic Protective Cover <small>(Remove after installation)</small>									
	<b>Operating Ambient Temp.:</b>	-22° to 104° F				[-30° to 40° C]					
	<b>Humidity:</b>	90% RH Non-Condensing									
	<b>Weight:</b>	2.66 lbs/sq. ft [13 kg/sq. m] with removable cover 1.96 lbs/sq. ft [9.6 kg/sq. m] without									
	<b>Mounting:</b>	Through Bolt in Pre-drilled Holes									
ELECTRICAL	<b>Diffusion:</b>	None									
	<b>Driver Type:</b>	Constant Voltage									
	<b>Input Voltage:</b>	24V DC									
	<b>Applied LED:</b>	Nichia 757g									
	<b>Power Consumption:</b>	4.0w/sq. ft. [43.0w/sq. m]									
	<b>Dimming:</b>	MLV, ELV, 0-10V, DALI, DMX									
	<b>Max Wattage per Tail:</b>	96w									
LISTINGS	<b>Feed Wire:</b>	96" [2.44m] of Non Plenum-Rated, 18 AWG Wire [1.02mm] No Connector; Plenum-Rated Wiring Optional									
	<b>UL US</b> UL 2108 & 8750; LM79, LM80 The EU's Restriction of Hazardous Substances Directive (RoHS) restricts the use of six hazardous substances* in electrical and electronic equipment (* Lead (Pb), Mercury, Cadmium, Hexavalent chromium, Polybrominated biphenyls and Polybrominated diphenyl ether (PBDE)).										
LIFE & WARRANTY	100,000 HR lifetime (T <sub>a</sub> = -25°C to 40°C; T <sub>c</sub> max 75°C); 5 year limited warranty										

### ELP-G LIGHT PANEL

EssentialLEDs® **ELP-G Light Panel** is a specialty backlighting product developed to provide bright and even backlighting for particularly demanding applications, including:

- Stretched Fabric Ceilings
- High Efficacy Needs
- Minimal Cavity Space

ELP-G features on-board power supply regulation on each individual ELP-G module, allowing panels to achieve the very high efficiency level of 140 lumens per watt (560 lumens per square foot\*).

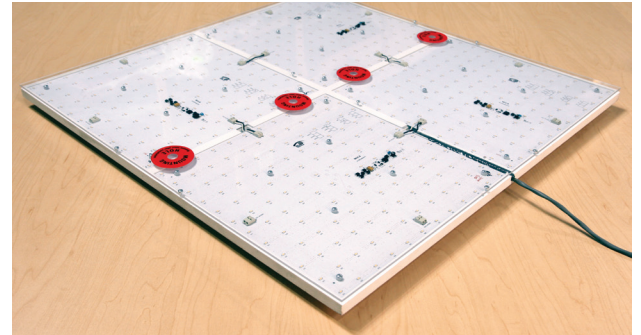
ELP-G can be fabricated in all shapes and sizes. It is dimmable and available in nine color temperatures (2000K, 2200K, 2500K, 2700K, 3000K, 3500K, 4000K, 4500K and 5000K) with a CRI of 83.

Visit the VLT website for application photos & most recent IES files, LM79 & LM80 reports.

MADE IN USA 

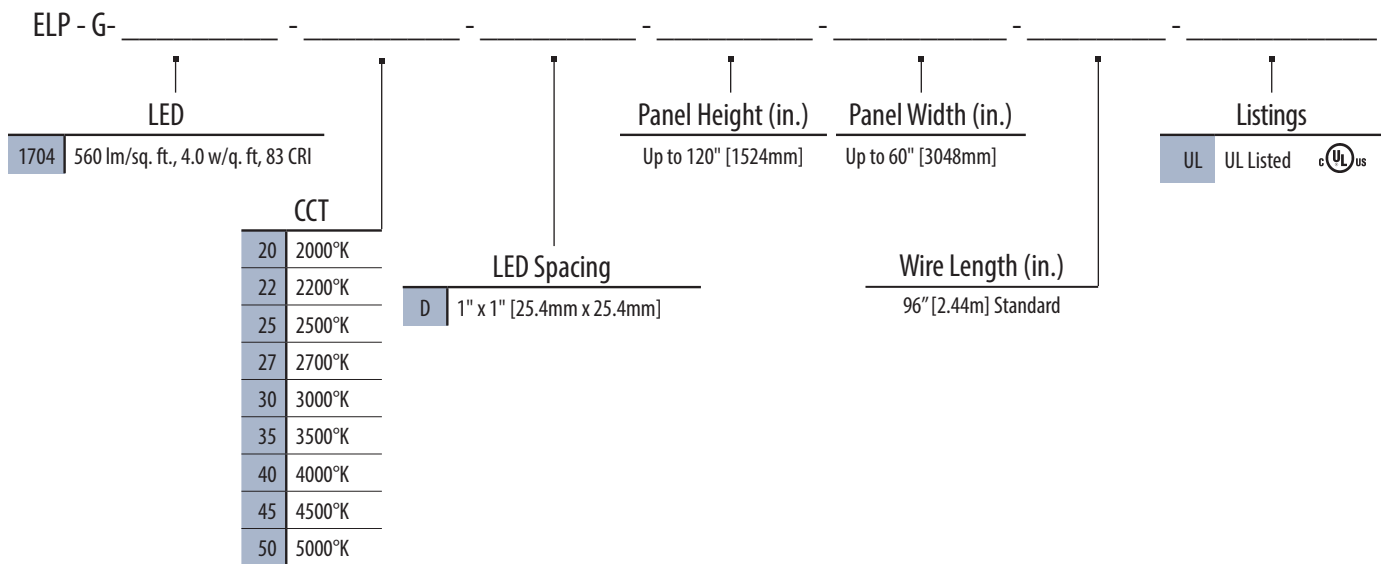
ELP-G LIGHT PANEL

IP20 | This product is ideal for backlighting stretched fabric ceilings in dry locations. Includes Nichia LEDs (560 lm/sq.ft., 4.0 w/sq.ft., 83CRI) arranged in a 1"x1" (nominal) grid with one pre-drilled mounting hole every 16" [406.4mm] on center. Standard finished thickness is 5/8" [15.9mm]. Available color temperatures of 2000K, 2200K, 2500K, 2700K, 3000K, 3500K, 4000K, 4500K and 5000K. All LEDs binned to within 2 MacAdam Ellipse CCT tolerance of ± 60°K.



To order standard shapes (squares, rectangles) and standard LED placements, use the configurator below. For custom shapes, custom LED placements, or custom mounting hole placements, please contact the VLT factory.

Edge to Edge: due to ELP-G's minimum LED module size of 3"x 3", please specify panel heights and widths divisible by 3 to achieve edge to edge LEDs.



Standard **ELP-G** modules are rectilinear, but angled and round shapes can also be evenly backlit.

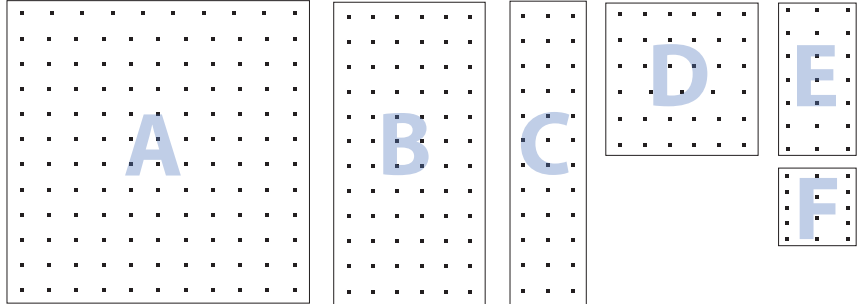




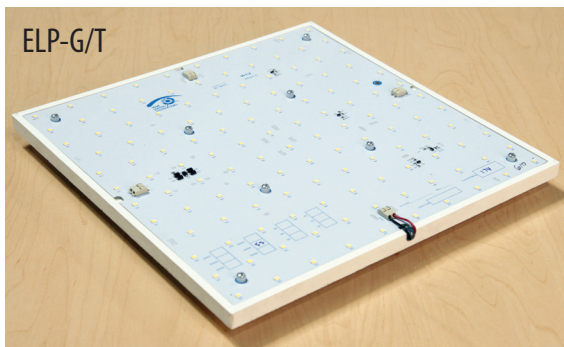
## ELP-G MODULES FOR DIY INSTALLATION

Individual ELP-G modules with 1" x 1" LED spacing can be purchased for mounting directly into your millwork or displays. All specifications and color temperature options are available. These versatile lighting units are offered in two versions, **Tiles**, which are pre-mounted onto 5/8" substrate, or LED Board only. Please note size difference between the two versions.

Module Sizes:		
	ELP-G/T Tiles	ELP-G/B Boards
<b>A</b>	12" x 12"	11.5" x 11.5"
<b>B</b>	12" x 6"	11.5" x 5.5"
<b>C</b>	12" x 3"	11.5" x 2.5"
<b>D</b>	6" x 6"	5.5" x 5.5"
<b>E</b>	6" x 3"	5.5" x 2.5"
<b>F</b>	3" x 3"	2.5" x 2.5"



**IP20 | Tiles:** these LED Tiles are mounted onto a 5/8" substrate with a 1/4" margin all around. ELP-G/T modules can be butted up against each other and will automatically maintain perfect spacing for even light output in any arrangement you desire. Features Nichia 757g LEDs (560 lm/sq. ft., 4.0 w/sq. ft., 83 CRI) arranged in a 1"x1" (nominal) grid. Available color temperatures of 2000K, 2200K, 2500K, 2700K, 3000K, 3500K, 4000K, 4500K. All LEDs binned to within 2 MacAdam Ellipse CCT tolerance of ± 60°K. Each tile ships with a protective cover which must be removed after installation. Includes 2" interconnect wires for daisy-chaining tiles together. Mix and match from the 6 module sizes below to configure your custom lighting solution.



ELP-G/T - 1704 - \_\_\_\_\_ - \_\_\_\_\_ - \_\_\_\_\_

CCT		Module Size		Listings
20	2000°K	1212	12" x 12" (4.0w)	UL   UL Listed cULus
22	2200°K	1206	12" x 6" (2.0w)	
25	2500°K	1203	12" x 3" (1.0w)	
27	2700°K	0606	6" x 6" (1.0w)	
30	3000°K	0603	6" x 3" (0.6w)	
35	3500°K	0303	3" x 3" (0.6w)	
40	4000°K			
45	4500°K			
50	5000°K			

**IP20 | Boards:** these LED boards consist of the LED Board ONLY with no backing material or preset outer spacing margin. Features 757g Nichia LEDs (560 lm/sq.ft., 4.0 w/sq.ft., 83 CRI) arranged in a 1"x1" (nominal) grid. Available color temperatures of 2000K, 2200K, 2500K, 2700K, 3000K, 3500K, 4000K, 4500K and 5000K. All LEDs binned to within 2 MacAdam Ellipse CCT tolerance of ± 60°K. No protective cover provided. Includes 2" interconnect wires for daisy-chaining tiles together. Mix and match from the 6 module sizes below to configure your custom lighting solution.



ELP-G/B - 1704 - \_\_\_\_\_ - \_\_\_\_\_ - \_\_\_\_\_

CCT		Module Size		Listings
20	2000°K	1212	11.5" x 11.5" (4.0w)	UL   UL Listed cULus
22	2200°K	1206	11.5" x 5.5" (2.0w)	CE   CE Marked CE
25	2500°K	1203	11.5" x 2.5" (1.0w)	
27	2700°K	0606	5.5" x 5.5" (1.0w)	
30	3000°K	0603	5.5" x 2.5" (0.6w)	
35	3500°K	0303	2.5" x 2.5" (0.6w)	
40	4000°K			
45	4500°K			
50	5000°K			

## LIGHT PANEL OPTIONS & ACCESSORIES

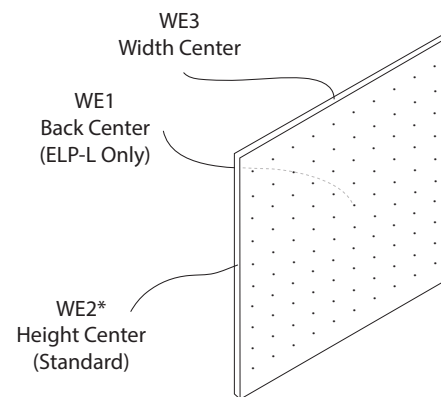
### SUBSTRATE THICKNESS

**ELP-L:** Standard thickness for EssentialLEDs® ELP-L Light Panel is 5/8", consisting of a 1/2" substrate plus 1/8" cover, bonded together [12.7mm substrate plus 3.2mm clear cover = 15.9mm]. For small pieces of light panel in wall-mounted applications (24" x 24" or less) [609.6mm x 609.6mm], the 3/8" Compact version may be sufficiently robust (1/4" substrate plus 1/8" cover) [6.4mm substrate plus 3.2mm cover = 9.5mm]. Please consult with the VLT factory for recommendations.

**ELP-G:** Standard thickness for ELP-G Light Panel is 5/8" [15.9mm]. ELP-G ships with a removable protective cover with a thickness of 1/8" [3.175mm].

### WIRE EXITS & OPTIONS

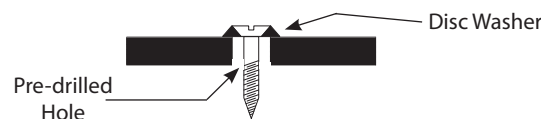
Wire exits can be located at any place along the Light Panel's edges, or from the back of the panel (ELP-L Only); illustration at right shows common exit designations. Unless otherwise specified, WE2\* is the standard wire exit; please provide a sketch for custom exit locations. WE1 exits will be located as close to center as possible, depending on LED board layout. Maximum wattage per driver is 96 watts, so larger pieces of Light Panel will often require multiple wire exits. Standard termination is 8' [2.44m] of non plenum rated 16-gauge [1.02mm<sup>2</sup>] wire, no connector; up to 30' [9.14m] is available as an option.



### MOUNTING

**ELP-L & ELP-G:** For wall-mount installations, EssentialLEDs® Light Panels install with #8 screws (provided by others; length will vary depending on mounting surface). In addition, #8 disc washers are provided with ELP-L panels to facilitate even load distribution. For a clean finish, white adhesive "dot" labels are provided to cover heads of #8 screws.

**ELP-G** ships with a removable clear cover to protect the LEDs during installation; clear cover should be discarded after mounting with #8 screws



### ELP-L DIFFUSER PANEL

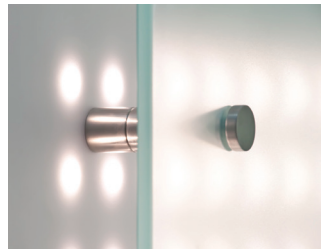
Acrylic diffuser panels are available to match the size and shape of your ELP-L LED Light Panel. Standard diffuser panel is fabricated using 0.25" [6.35mm] Opal 3 white acrylic. We can also fabricate diffuser panels using alternative acrylics, decorative resins or other materials per your specification. Please contact VLT factory for other options. In most cases, diffuser panels must be mounted a minimum of 2" from the Light Panel, and can be supported using stand-off hardware or other structure provided by the application. When mounting diffuser panel with stand-off hardware, spacing of every 16" - 24" [400mm - 600mm] on center is recommended.



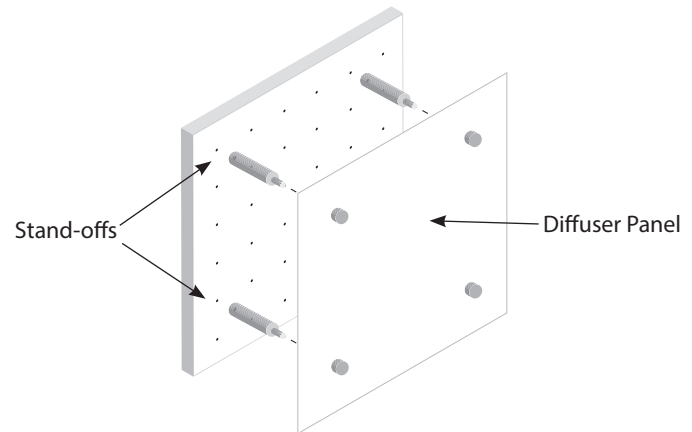
## ELP-L STAND-OFF HARDWARE FOR USE WITH ACRYLIC DIFFUSER

For wall-mount applications, aluminum stand-offs provide a simple way to mount materials being backlit. Stand-offs provide a fixed 2" [12.7mm] separation that allows full blending of the LED light points. Stand-off hardware is typically placed every 16" - 24" [400mm - 600mm] OC. See illustration below.

Installation with Diffuser Panel Using Stand-off Hardware



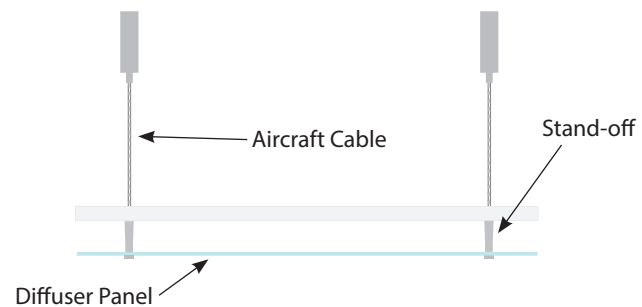
(Illustration uses frosted glass diffuser; visible dot pattern is design choice)



## ELP-L SUSPENSION HARDWARE

LED Light Panel can be used as general overhead lighting when combined with a T-Bar system (provided by others) or suspended by a combination of specialized grips and aircraft cable. See illustration below.

Suspended Mount Using Cable & Grips (Aluminum Framing Required)



## ELP-L ALUMINUM FRAMING

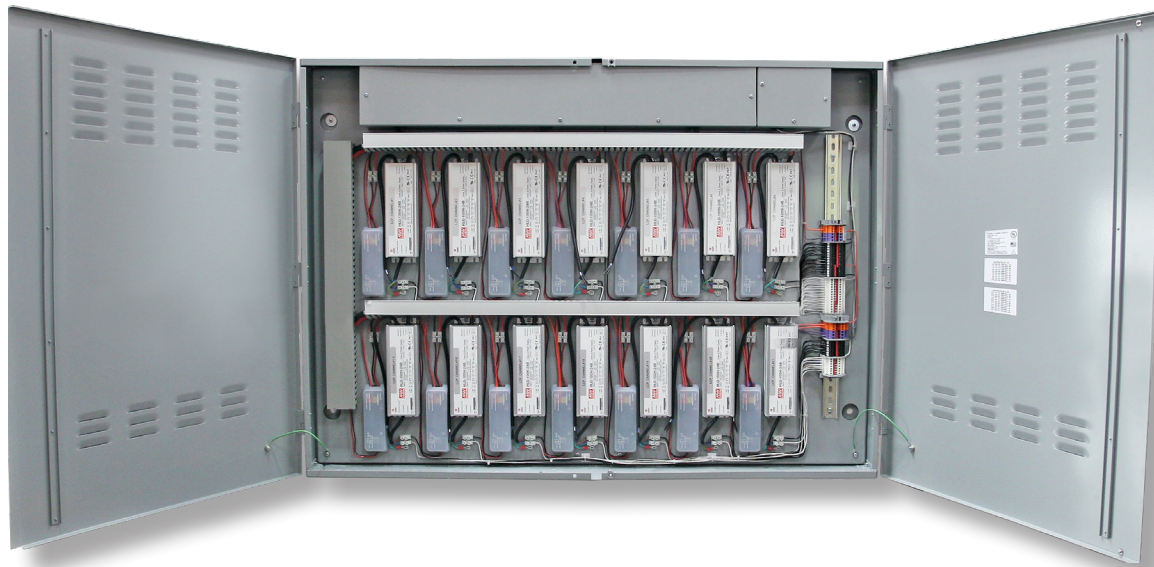
When large pieces of ELP-L LED Light Panel are used in suspended applications, aluminum framing is available to provide added rigidity and support for the PVC substrate to prevent bowing of the panel. Aluminum framing will add a slight raised edge ( $\frac{1}{8}$ " [3.2mm]) around the periphery of the panel, but will not alter the height and width dimensions of the panel. The framing itself cannot be used to support the light panel in a suspended application; cable attachments must penetrate the panel substrate (see photo above).

## ELP-L SUBSTRATE COLOR

Depending on your application, a substrate color other than the standard white may be desirable for your ELP-L LED Light Panel. Expanded PVC plastic comes in a variety of colors (Black, Gray, Beige, Purple, Burgundy, Red, Orange, Yellow, Green & Blue); please contact factory for samples.



## POWER PANELS & DRIVERS



**The correct driver** ensures that an LED lighting application performs at its best, delivering consistent light output, smooth dimming, and compatibility with controls systems. VLT offers a wide selection of constant voltage and constant current units, all of which have been tested for optimum performance with our Linear, Panel and Specialty Display fixtures.

**LED Driver Power Panels** are designed to accommodate multiple LED Drivers - constant voltage, constant current, or a customized mix of both, tailored to your application. **Power Panels** provide tidy storage, easy access, and simplified maintenance and trouble-shooting, and are perfect for large projects - retail, commercial or residential - where many drivers are required. **Power Panel** units are UL Listed as a unit and require just one power input for as many as 64 low voltage outputs.

Large LED lighting installations can require dozens of drivers. The task of organizing, storing, accessing and controlling them all becomes a challenge. In today's retail environment, remote drivers end up scattered throughout the store - some stored in millwork, where they take valuable storage space and produce merchandise-damaging heat. Dozens more end up in the hard-to-access plenum space above downlight fixtures.

**Power Panels** provide a secure, organized and ventilated back-of-house unit to contain and control multiple drivers. Initial installations are easier and require less electrician time because a single power input runs multiple drivers. Future maintenance is easier and helps to avoid store shut-downs. Organized Power Panels also facilitate trouble-shooting by making it easy to identify the driver that connects to every LED fixture in the store.

## LED DRIVER POWER PANEL

For constant current fixtures, each LED Driver Power Panel incorporates **up to 16 - 100w eldoLED constant current drivers**; for constant voltage applications, each unit incorporates **up to 14 - 100w Meanwell HLG constant voltage drivers**, paired with an **eldoLED LINEARdrive control module**. Both versions facilitate easy integration with **DALI, DMX or 0-10v control systems**, and insure smooth, natural, video-flicker-free dimming down to zero, with full control of the dimming curve.

Each LED Driver Power Panel provides up to **2 input circuits** (1 main and 1 alternate power sources such as battery backup), and up to **64 low voltage (class 2) output wires**. Both 120 - 277v input and low voltage outputs can accommodate up to #8 AWG wire; within the unit, wire management channels keep wires under control. Wire pass-thru inside each box allows units to be closely stacked and wired together.

## New! MINI DRIVER POWER PANEL

Like our original LED Driver Power Panel, only smaller...and it can be recessed! Our constant current panel is available with either **4 or 9 - 60w or 100w Magnitude AFlex drivers**, while our constant voltage panel comes with **3 or 7 - 96w Magnitude SoliDrive drivers, 4 or 9 - 96w Magnitude E-Series drivers, or 3 or 7 - 96w VLT HELD drivers**. When choosing 3 or 4 driver models, the Power Panel will be a single high unit (like the one shown here.) With 7 or 9 drivers, you will get a double high configuration with a single cover plate.

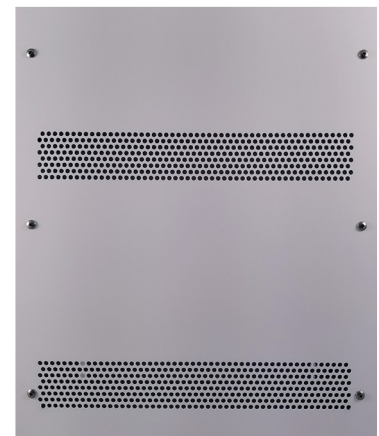
In both single and double configurations, your installation will require only 1 single power input, 1 single control input, and 1 low voltage output per driver. And since **Mini-Recessed Power Panel** is sized to fit in between standard wall studs, mounting your panel is just as easy as wiring it up.

- **Organized & Accessible**
- **Convection Cooled**
- **Easy Connection to DALI<sup>1</sup>, DMX<sup>1</sup>, 0-10v or Phase<sup>1</sup> Control**
- **Orderly Wire Management**
- **Easier Trouble-Shooting**
- **Wire Pass-Thru for Installation of Multiple Panels<sup>1</sup>**
- **UL and CE Listed**
- **Smooth Dimming to 0.1%<sup>1</sup>**
- **Feed and Load Wiring Only  
No Other Wiring or Assembly Required.**

<sup>1</sup> Feature available on select models. Review model cutsheets for more information.

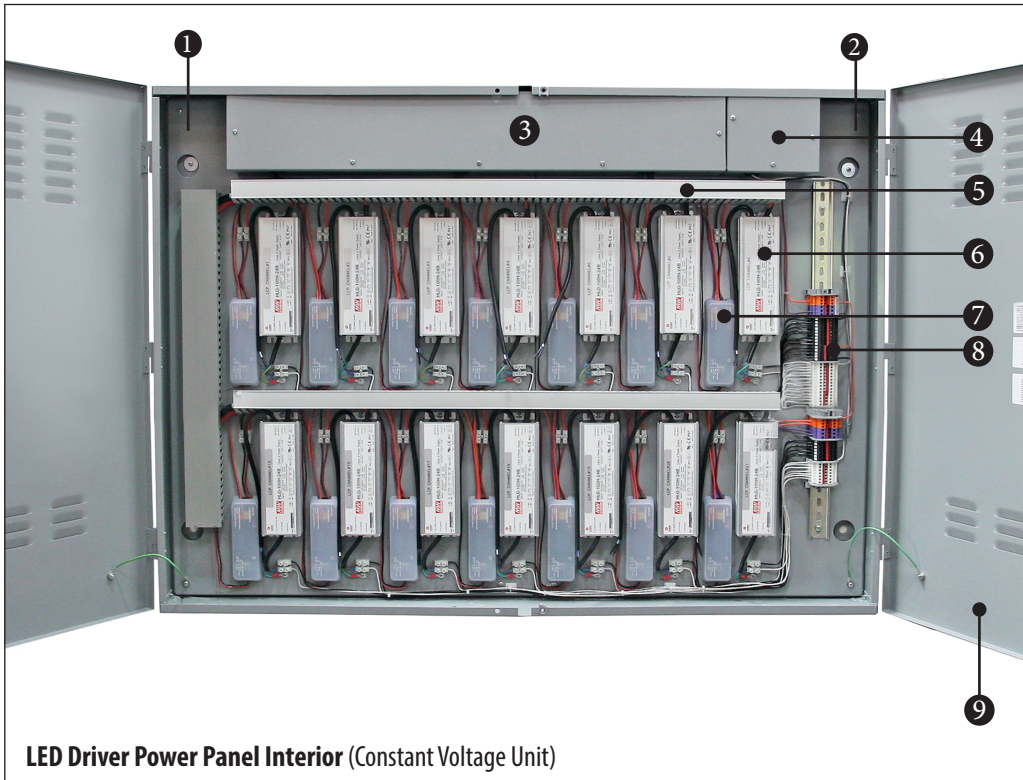


LED Driver Power Panel Exterior



Mini-Recessed Power Panel Exterior

LED DRIVER POWER PANEL FEATURES

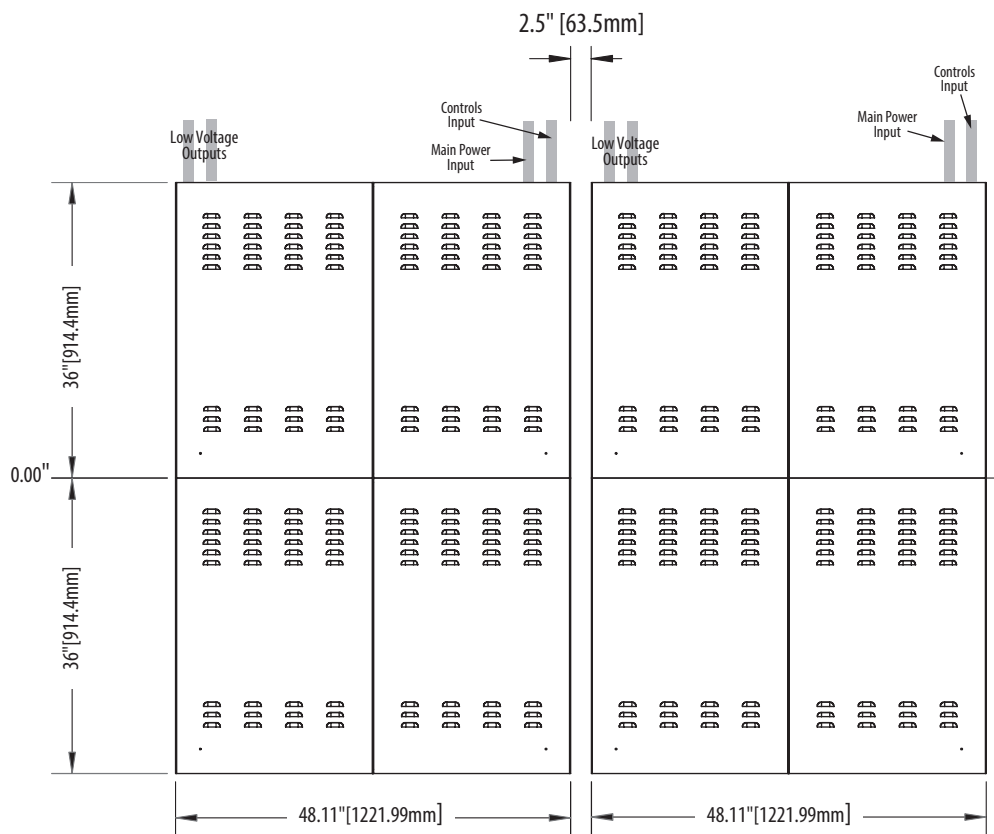


- 1 Wire Management Channel
- 2 Pre Punch Knockouts
- 3 Output Terminal Blocks (56) (Low Voltage Class 2)
- 4 Input Terminal Blocks(3) (Line Voltage, Alternate Power)
- 5 Wire Management Channel
- 6 Driver (CC or CV)
- 7 eldoLED LINEAR Drive Control Module (CV only)
- 8 Control Terminal Block
- 9 Removable Doors

LED Driver Power Panel Interior (Constant Voltage Unit)

**Multiple LED Driver Power Panels** can be wall-mounted in close proximity to each other. No separation is required between vertically stacked units, and a Pass Thru is provided for feeding wires from unit to unit.

For units mounted side-by-side, allow 2.5" [63.5mm] separation between units to allow hinged doors to open.



## THE ESSENTIALLEDs DRIVER POWER PANEL - CONSTANT CURRENT

### Input Characteristics

Input Voltage AC	120-277V (UL approved) 1-phase, 2wire
Input Current	120V/60Hz: 14.0A, 230V/50hz: 7.0A, 277V/60Hz: 6A
Input Frequency	50-60Hz
Efficiency @ Full Load	90%
Efficiency @ 1/2 Load	≥87%
Power Factor @ Full Load	>0.94
THD@ full load	<10%
Inrush Current	141A @ 120V/60Hz
Surge Protection	3kV (L to N), 4kV (L/n to GND)
Standby Power	<0.5W



### Output Characteristics

LED Output Power	100W max each driver; (1400w total)
LED Output Current Range	200-1,400mA (settable per output)
LED Output Current Resolution	Programmable in 1mA steps
LED Output Current Tolerance	± 5%
LED Outputs	64 max. ( UL Class 2)
LED Output Voltage Range	2-57V

### Control Characteristics

Control Channels	14
Dimming Protocol	DALI / DMX / 0 - 10V
Dimming Range	100%-0.1% (up to 1050 mA) 100%-1% (over 1050 mA)
Dimming Method	Hybrid HydraDrive
Dimming Curve	Linear or Logarithmic
Driver Configuration	with TOOLbox pro and FluxTool

### Standards and Certifications

EN	61347-1/-2-13, 62384, 55015, 55022, 61000-3-2, 61547, 62386-101/-102/-207
UL	 UL 2108 (Class 2 Output)
RoHS	 RoHS2

### Wiring Specifications

Wire Type Input/Output	AWG 24 Min - AWG 8 Max, 0.2 - 10.0mm; Solid or Stranded Copper
Wire Type Control Signal	AWG 26 Min - AWG 12 Max, 0.14 - 2.5mm; Solid or Stranded Copper

### Thermal Protection

External NTC Thermistor	Throttling @ 70°C / 158 °F (settable)
Externam Thermistor Value	47kΩ

### Thermal Specification

Ta Operating Range	-40 °C...+50 °C / -40 °F...+122 °F
--------------------	------------------------------------

### Warranty

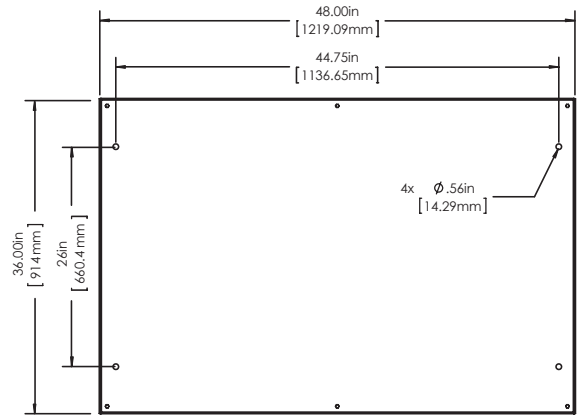
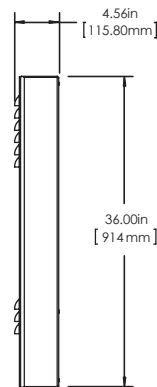
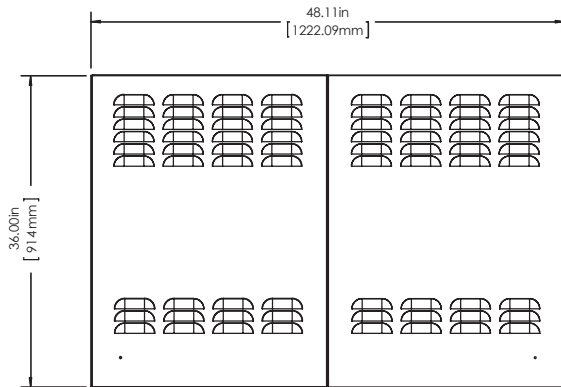
Warranty Period	3 years
-----------------	---------

### Dimenstions and Weight

Dimensions	48" x 36" x 4.56" / 1219mm x 914mm x 115mm
Cabinet Weight	73 lbs / 33.1 kg
Shipping Weight	215 lbs / 97.5 kg
Mounting	(4x) 1/4 -20 Lag Bolts, 0 clearance top to bottom, 2.5" [63.5mm] between panels



THE ESSENTIALLEDs DRIVER POWER PANEL - CONSTANT CURRENT



Front View



Side View

Mounting Hole Pattern

LDPP -

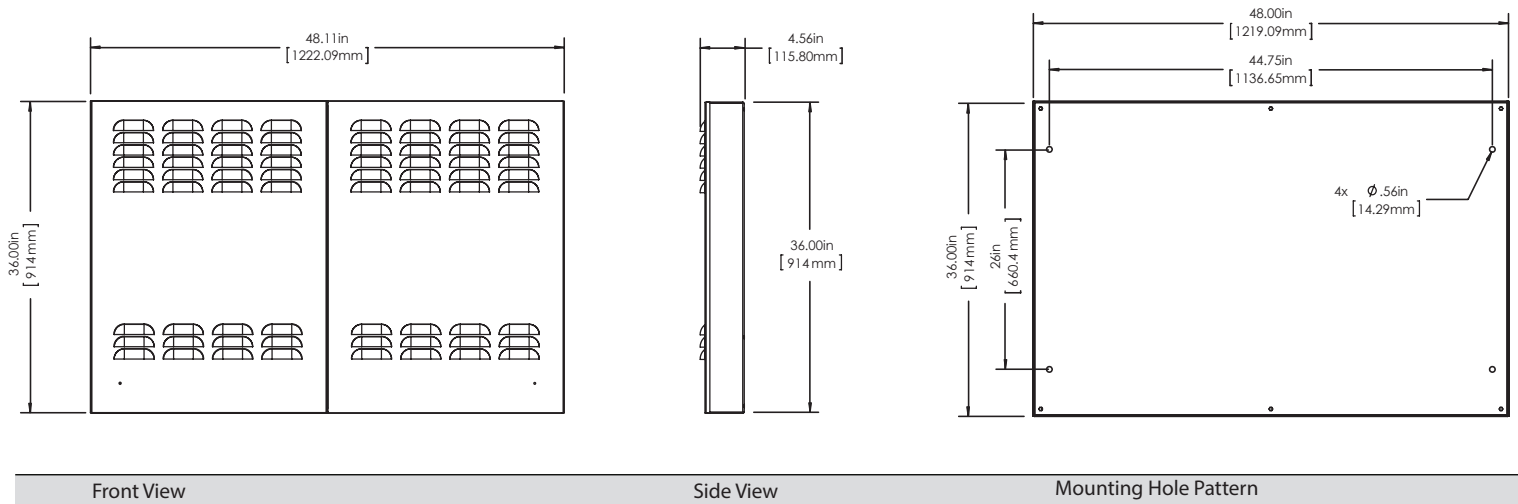
Type		Input Volts		No. of Outputs		Output Current		Control Signal		Options	
CC	Constant Current	UNV	120-277V/50-60Hz	32	32	350	350mA	DAL	Dali	MB	Main Breaker <sup>2</sup>
				64	64	500	500mA	DMX	DMX	DH	Dali Hub <sup>2</sup>
				C	Custom <sup>1</sup>	700	700mA	010	0-10V	DX	DMX Splitter <sup>2</sup>
				<sup>1</sup> Must be in groups of four		1050	1050mA			<sup>2</sup> Consult factory for details	
						1400	1400mA				
						C	Custom				
		No. of Inputs						Dimming Curve			
		1	Main					LN	Linear		
		2	Main + 1 Alternate Power Source					LG	Logarithmic		
								Ratings			
								UL	UL Listed	UL US	
								CE	CE Listed	CE	

## THE ESSENTIALLEDs DRIVER POWER PANEL - CONSTANT VOLTAGE

Input Characteristics	
Input Voltage AC	120-277V (UL approved) 1-phase, 2 wire
Input Current	120V/60Hz: 13A, 230V/50hz: 7A, 277V/60Hz: 6.8A
Input Frequency	47-63Hz
Efficiency @ Full Load	93%
Efficiency @ 1/2 Load	≥83%
Power Factor @ Full Load	>0.98
THD@ full load	<20%
Inrush Current	69A @ 120V/60Hz
Surge Protection	3kV (L to N), 4kV (L/n to GND)
Standby Power	<0.5W
Output Characteristics	
LED Output Power	100W max each driver; (1400w total)
LED Output Voltage	12V or 24V DC
LED Output Current Tolerance	1%
LED Outputs	14 max. ( UL Class 2)
Control Characteristics	
Control Channels	14
Dimming Protocol	DALI / DMX / 0-10V
Dimming Range	100%-0.1%
Dimming Method	Hybrid HydraDrive
Dimming Curve	Linear or Logarithmic
Driver Configuration	with TOOLbox pro and FluxTool
Standards and Certifications	
EN	61347-1/-2-13, 55015, 55022, 61000-3-2, 61547
UL	 UL 2108 (Class 2 Output)
RoHS	 RoHS2
Wiring Specifications	
Wire Type Input/Output	AWG 24 Min - AWG 8 Max, 0.2 - 10.0mm; Solid or Stranded Copper
Wire Type Control Signal	AWG 26 Min - AWG 12 Max, 0.14 - 2.5mm; Solid or Stranded Copper
Warranty	
Warranty Period	3 years
Dimensions and Weight	
Dimensions	48" x 36" x 4.56" / 1219mm x 1219mm x 115mm
Cabinet Weight	85 lbs / 38.6 kg
Shipping Weight	238 lbs / 108 kg
Mounting	(4x) 1/4 -20 Lag Bolts, 0 clearance top to bottom, 2.5" [63.5mm] between panels



THE ESSENTIALLEDs DRIVER POWER PANEL - CONSTANT VOLTAGE



LDPP -

<b>Type</b>		<b>Input Volts</b>		<b>No. of Outputs</b>		<b>Control Signal</b>		<b>Dimming Curve</b>		<b>Options</b>	
CV	Constant Voltage	UNV	120-277V/50-60Hz	14	14	DAL	Dali	LN	Linear	MB	Main Breaker <sup>1</sup>
				C	Custom	DMX	DMX	LG	Logarithmic	DH	Dali Hub <sup>1</sup>
						010	0-10V			DX	DMX Splitter <sup>1</sup>
		<b>No. of Inputs</b>		<b>Output Voltage</b>		<b>Ratings</b>					
		1	Main	12	12V DC	UL	UL Listed	cUL <sup>us</sup>			
		2	Main + 1 Alternate Power Source	24	24V DC	CE	CE Listed	CE			

<sup>1</sup> Consult factory for details

## THE ESSENTIALLEDs DRIVER POWER PANEL - CUSTOM - MIXED CV & CC

### Input Characteristics

Input Voltage AC	120-277V (UL approved) 1-phase, 2wire
Input Current	120V/60Hz: 14.8A, 230V/50hz: 7.4A, 227V/60Hz: 6.8A
Input Frequency	50-60Hz
Efficiency @ Full Load	90%
Efficiency @ 1/2 Load	≥87%
Power Factor @ Full Load	>0.94
THD@ full load	<10%
Inrush Current	141A @ 120V/60Hz
Surge Protection	3kV (L to N), 4kV (L/n to GND)
Standby Power	<0.5W



### Output Characteristics

LED Output Power	100W max each driver; (1400w total)
LED Output Current Range	200-1,400mA (settable per output)
LED Output Current Resolution	Programmable in 1mA steps
LED Output Current Tolerance	± 5%
LED Outputs	35 max. ( UL Class 2)
LED Output Voltage Range	2-57V

### Control Characteristics

Control Channels	14
Dimming Protocol	DALI / DMX / 0-10V
Dimming Range	100%-0.1% (up to 1050 mA) 100%-1% (over 1050 mA)
Dimming Method	Hybrid HydraDrive
Dimming Curve	Linear or Logarithmic
Driver Configuration	with TOOLbox pro and FluxTool

### Standards and Certifications

EN	61347-1/-2-13, 62384, 55015, 55022, 61000-3-2, 61547, 62386-101/-102/-207
UL	 UL 2108 (Class 2 Output)
RoHS	 RoHS2

### Wiring Specifications

Wire Type Input/Output	AWG 24 Min - AWG 8 Max, 0.2 - 10.0mm; Solid or Stranded Copper
Wire Type Control Signal	AWG 26 Min - AWG 12 Max, 0.14 - 2.5mm; Solid or Stranded Copper

### Thermal Protection

External NTC Thermistor	Throttling @ 70°C / 158 °F (settable)
Externam Thermistor Value	47kΩ

### Thermal Specification

Ta Operating Range	-40 °C...+50 °C / -40 °F...+122 °F
--------------------	------------------------------------

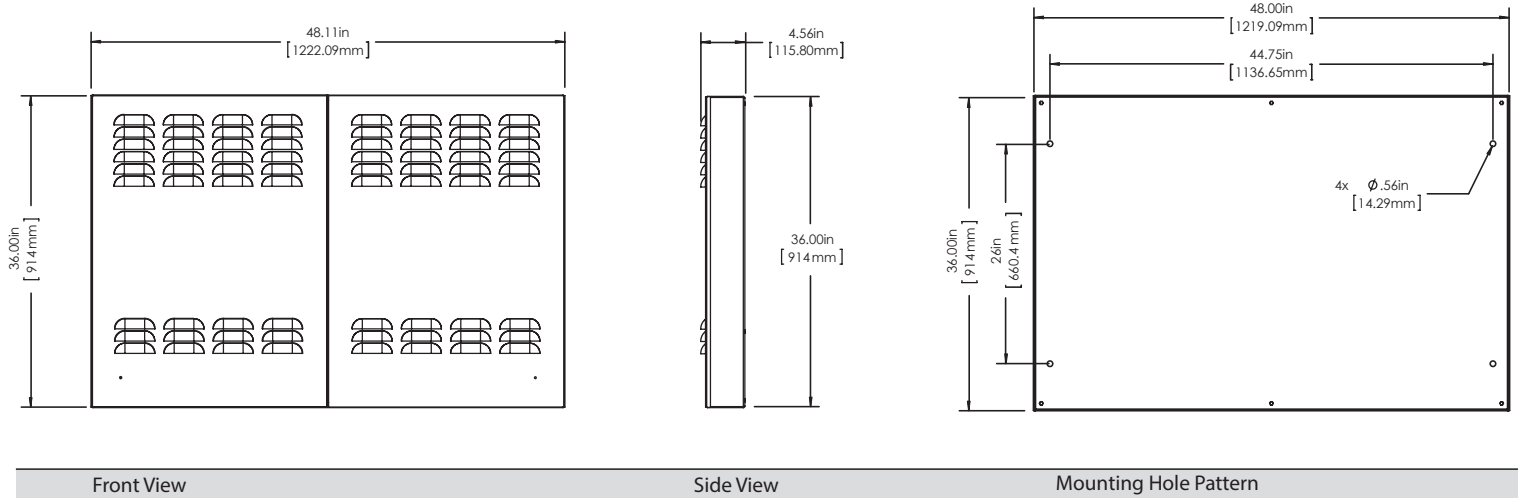
### Warranty

Warranty Period	3 years
-----------------	---------

### Dimenstions and Weight

Dimensions	48" x 48" x 4.56" / 1219mm x 1219mm x 115mm
Cabinet Weight	109 lbs / 49.5 kg
Shipping Weight	251 lbs / 114 kg
Mounting	(4x) 1/4 -20 Lag Bolts, 0 clearance top to bottom, 2.5" [63.5mm] between panels

THE ESSENTIALLEDs DRIVER POWER PANEL - CUSTOM - MIXED CV & CC



LDPP -

<b>Type</b>		<b>No. of Inputs</b>		<b>CC Output Current</b>		<b>Control Signal</b>		<b>Ratings</b>	
CC/CV	Mixed Constant Current or Constant Voltage	1 Main	2 Main + 1 Alternate Power Source	350 350mA	500 500mA	DAL Dali	DMX DMX	UL UL Listed	CE CE Listed
<b>Input Volts</b>		<b>No. of Outputs</b>		<b>CV Output Voltage</b>		<b>Dimming Curve</b>		<b>Options</b>	
UNV	120-277V/50-60Hz	28/7	28 Constant Current 7 Constant Voltage	12 12V DC	24 24V DC	LN Linear	LG Logarithmic	MB Main Breaker <sup>1</sup>	DH Dali Hub <sup>1</sup>
								DX DMX Splitter <sup>1</sup>	

<sup>1</sup> Consult factory for details

## ESSENTIALLEDs MINI DRIVER POWER PANEL-CONSTANT CURRENT

### Input Characteristics

Input Voltage AC	120-277V (UL approved) 1-phase, 2wire
Input Current	120V: 5.4A, 277V: 2.25A
Input Frequency	50-60Hz
Efficiency	>90%
Power Factor	0.992 @ 120 VAC, 0.95 @ 277 VAC
THD@ full load	<20%
Inrush Current	38A Max
Surge Protection	2.5 KV
Standby Power	>1W



### Output Characteristics

LED Output Power	60W or 100W max each driver; (540w or 900w total)
LED Output Current Range	100-2,000mA (settable per output)
LED Output Current Resolution	Programmable in 1mA steps
LED Output Current Tolerance	± 5%
LED Outputs	9 Max ( UL Class 2)
LED Output Voltage Range	3-57V

### Control Characteristics

Control Channels	4 or 9
Dimming Protocol	0 - 10V
Dimming Range	100%-0.1%
Dimming Curve	Linear or Logarithmic
Driver Configuration	with Flex Tool

### Standards and Certifications

EN	61347-1/-2-13, 62384, 55015, 55022, 61000-3-2, 61547, 62386-101/-102/-207
UL	 UL 2108 (Class 2 Output)
RoHS	 RoHS2

### Wiring Specifications

Wire Type Input/Output	AWG 20 Min - AWG 16 Max; Solid or Stranded Copper
Wire Type Control Signal	AWG 20 Min - AWG 16 Max; Solid or Stranded Copper

### Thermal Protection

NTC Value	Vishay 15kΩ ± 5% @ 25 °C
-----------	--------------------------

### Thermal Specification

Ta Operating Range	-40 °C...+50 °C / -40 °F...+122 °F
--------------------	------------------------------------

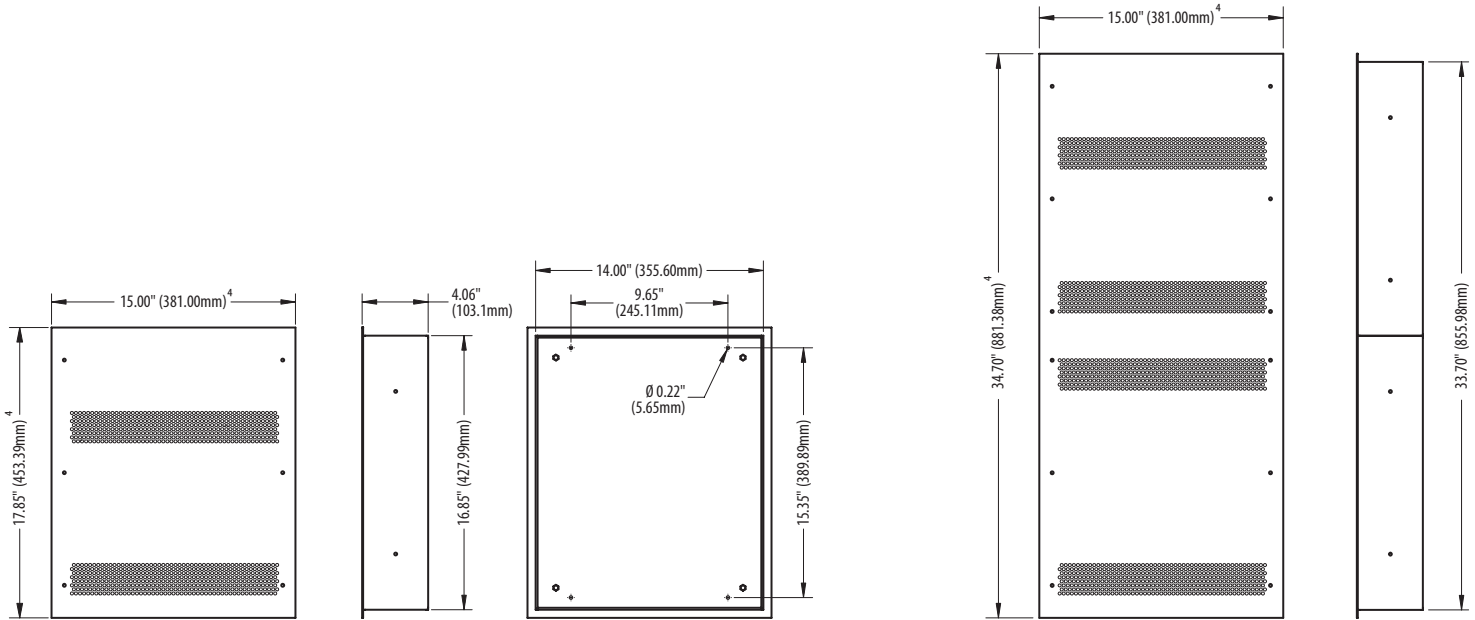
### Warranty

Warranty Period	3 years
-----------------	---------

### Dimensions and Weight

Recessed Dimensions	Single: 15.00" x 17.85" x 4.06" Double: 15.00" x 34.70" x 4.06"
Surface Mount Dimensions	Single: 14.00" x 16.85" x 4.06" Double: 14.00" x 33.70" x 4.06"
Cabinet Weight	Single: 12.65 lbs Double: 24.75 lbs
Mounting	(4x) 1/4 -20 Lag Bolts, 0 clearance top to bottom, 2.5" [63.5mm] between panels

ESSENTIALLEDs MINI DRIVER POWER PANEL-CONSTANT CURRENT



<sup>4</sup> Subtract 1" (25.4mm) from this dimension for surface mount version

Single Configuration

Double Configuration

LMPP - CC - \_\_\_\_\_ - \_\_\_\_\_ - \_\_\_\_\_ - \_\_\_\_\_ - 010 - \_\_\_\_\_ - \_\_\_\_\_ - \_\_\_\_\_ - UL

Mounting

R	Recessed
S	Surface Mount

No. of Outputs

4	4 <sup>1</sup>
9	9 <sup>2</sup>

<sup>1</sup> Single Configuration  
<sup>2</sup> Double Configuration

Control Signal

010	0-10V
-----	-------

Finish

WH	White
BL	Black

Model

A	A-Flex 60W, 120-277V/50-60Hz
B	A-Flex 100W, 120-277V/50-60Hz

Output Current

350	350mA
500	500mA
700	700mA
1050	1050mA
1400	1400mA
2000	2000mA <sup>3</sup>
C	Custom

<sup>3</sup> Output Current over 1400mA only Available in Model B

Dimming Curve



LN	Linear
LG	Logarithmic

Ratings

UL	UL Listed cUL <sub>us</sub>
----	-----------------------------

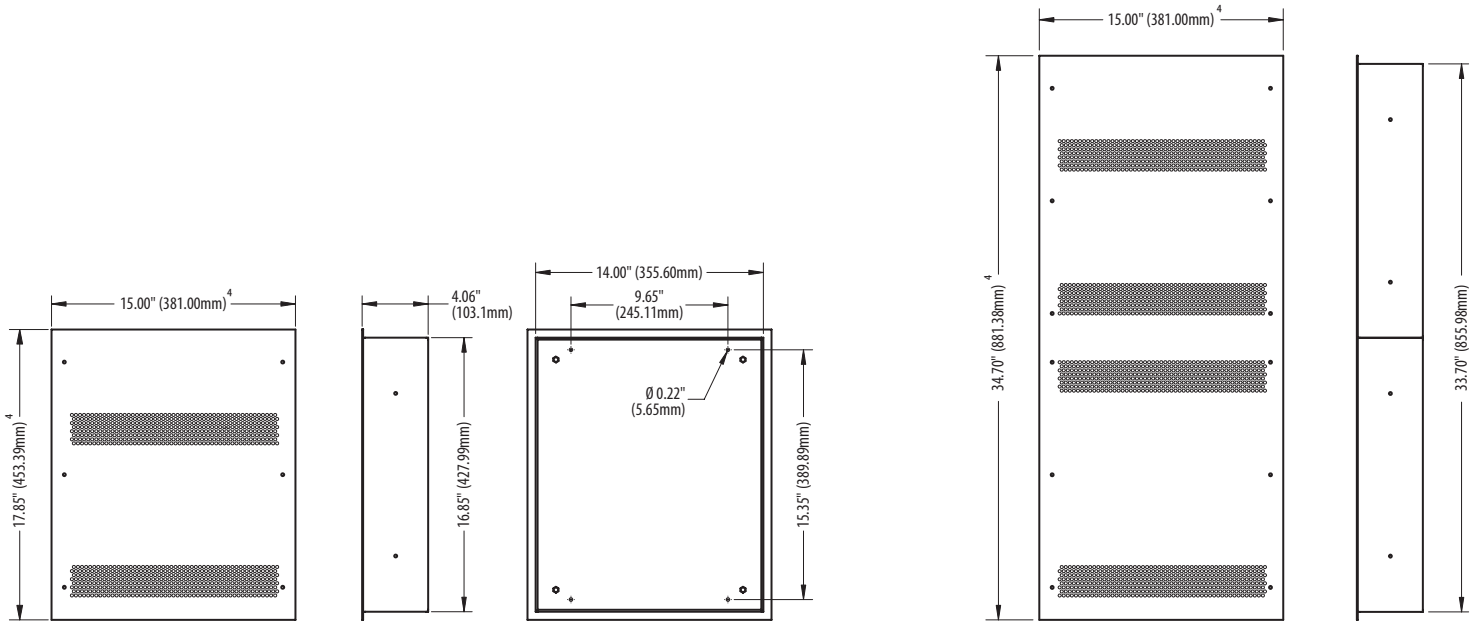


## ESSENTIALLEDs MINI DRIVER POWER PANEL - CONSTANT VOLTAGE

Driver Models	
Model A	Magnitude E-Series
Model B	Magnitude SoliDrive
Model C	VLT Hybrid Electronic Low-Voltage (HELD)
Input Characteristics	
Input Voltage AC	A: 120V, B: 120-277V, C1: 90-130V, C2: 200-277V
Input Current	A: 1A, B: 0.96A, C1: 0.88A, C2: 0.44A
Input Frequency	A: 60Hz, B: 50-60Hz, C1: 60Hz, C2: 50Hz
Efficiency @ Full Load	A: >90%, B: >87%, C1 & C2: 80-85%
Power Factor @ Full Load	A: 0.95, B: >0.95, C1 & C2: TBD
THD@ full load	<20%
Inrush Current	A: TBD, B: 5A @ 120V 30A @ 277V, C1 & C2: <1A
Output Characteristics	
LED Output Power	96W max each driver; (864w total max)
LED Output Voltage	24V DC
LED Output Current Tolerance	>3%
LED Outputs	9 max ( UL Class 2)
Control Characteristics	
Control Channels	3, 4, 7 or 9
Dimming Protocol	Phase Control/ 0-10V
Dimming Range	100% -1%
Dimming Curve	Linear
Standards and Certifications	
EN	61347-1/-2-13, 55015, 55022, 61000-3-2, 61547
UL	 UL 2108 (Class 2 Output)
RoHS	 RoHS2
Wiring Specifications	
Wire Type Input/Output	AWG 24 Min - AWG 8 Max, 0.2 - 10.0mm; Solid or Stranded Copper
Wire Type Control Signal	AWG 26 Min - AWG 12 Max, 0.14 - 2.5mm; Solid or Stranded Copper
Warranty	
Warranty Period	3 years
Dimensions and Weight	
Recessed Dimensions	Single: 15.00" x 17.85" x 4.06" Double: 15.00" x 34.70" x 4.06"
Surface Mount Dimensions	Single: 14.00" x 16.85" x 4.06" Double: 14.00" x 33.70" x 4.06"
Cabinet Weight	Single: 18.0 lbs Double: 37.6 lbs
Mounting	(4x) 1/4 -20 Lag Bolts, 0 clearance top to bottom, 2.5" [63.5mm] between panels



ESSENTIALLEDs MINI DRIVER POWER PANEL-CONSTANT VOLTAGE



<sup>4</sup> Subtract 1" (25.4mm) from this dimension for surface mount version

Single Configuration

Double Configuration

LMPP - CV - 24 - LN - UL

Mounting

R	Recessed
S	Surface Mount

No. of Outputs

3	3 <sup>3</sup>
4	4 <sup>3</sup>
7	7 <sup>4</sup>
9	9 <sup>4</sup>

<sup>3</sup> Single Configuration  
<sup>4</sup> Double Configuration

Control Signal

PH	Phase <sup>5</sup>
010	0-10V <sup>6</sup>

<sup>5</sup> Only Available in Models A, C1, C2  
<sup>6</sup> Only Available in Model B

Finish

WH	White
BL	Black

Model

A	E-Series 96W, 120V/60Hz <sup>1</sup>
B	SolidDrive 96W, 120-277V/50-60Hz <sup>2</sup>
C1	HELD 96W, 90-130V/60Hz <sup>2</sup>
C2	HELD 96W, 200-277V/50-60Hz <sup>2</sup>

<sup>1</sup> Available in 4 or 9 Outputs Only  
<sup>2</sup> Available in 3 or 7 Outputs Only

Output Voltage

24	24V DC
----	--------

Dimming Curve

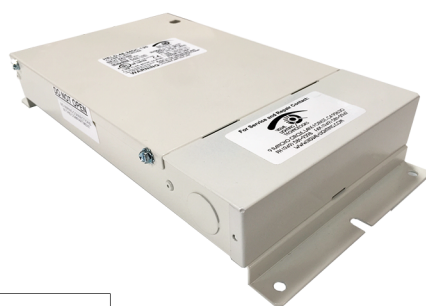
LN	Linear
----	--------

Ratings

UL	UL Listed  US
----	---------------

## LED DRIVERS

---



---

VLT offers the best LED Drivers from the most reputable manufacturers. Whether Non Dimming, 0-10v, DMX/DALI or Phase Control. Constant Current or Constant Voltage. UL or CE. We are sure to have the drivers to complete your application.

Visit us online at [vltcorp.com](http://vltcorp.com) to find specs and cutsheets; or call one of our application specialists at (877) VLT-1167 for a recommendation.

## PRODUCT LISTINGS

EssentialLEDs® products are listed to **UL Standards 2108 and 8750**; for use within a closet storage space, fixtures must be lensed with a maximum wattage of 2.9w per ft. For millworkers, a UL Listed EssentialLEDs® system can be easily integrated into casework for a UL65 listing.

The CE mark includes RoHS compliance (Restriction of Hazardous Substances Directive), insuring products will not contain any of the following substances: lead (Pb), mercury (Hg), cadmium (Cd), Hexavalent chromium (Cr6+), Polybrominated biphenyls (PBB) or Polybrominated diphenyl ether (PBDE). EU Countries that require RoHS compliance include Austria, Belgium, Bulgaria, Cyprus, Denmark, Estonia, Finland, France, Germany, Greece, Hungary, Ireland, Italy, Latvia, Lithuania, Luxembourg, Malta, Netherlands, Poland, Portugal, Romania, Slovakia, Slovenia, Spain, Sweden and the United Kingdom. Countries requiring RoHS or "similar" restrictions include Canada, China, Japan, New Zealand and South Korea. CE mark drivers are required for a CE mark system.

For complete systems to be UL Listed, EssentialLEDs® fixtures must be combined with a UL Listed Class 2 power supply.

EssentialLEDs® **LED Driver Power Panels** were developed for large projects - retail, commercial or residential - that require housing and controlling many drivers. A single input for power and a single control input makes installation easy. **Power Panels are UL Listed as a single unit.**

**Notes:** \_\_\_\_\_  
\_\_\_\_\_  
\_\_\_\_\_  
\_\_\_\_\_  
\_\_\_\_\_  
\_\_\_\_\_  
\_\_\_\_\_  
\_\_\_\_\_  
\_\_\_\_\_  
\_\_\_\_\_  
\_\_\_\_\_  
\_\_\_\_\_  
\_\_\_\_\_



9SL Vanity Lighting  
Claudia Librett, 521 Atelier, LLC  
Photo by Jeffrey Totaro

## Terms & Conditions

**1. Orders:** Orders for Visual Lighting Technologies (VLT) will be accepted only with a written Purchase Order. This order shall be subject to all sales, use, excise and other taxes. Customer is responsible for furnishing a resale certificate. Accounting terms should be agreed upon prior to order placement. Hold for "Release" purchase orders may be accepted, but will require a 50% deposit to hold quoted price. Both Hold for Release and released PO's requiring a submittal package will be required to pay a non-cancellable 10% deposit. VLT has a \$100 minimum order policy. RUSH orders are subject to an additional 15% processing fee.

**2. Credit:** All new credit accounts must sign a completed credit application form and must furnish VLT with their standard credit references. Please allow five business days to establish credit. Unless credit is established, a pre-payment by credit card, check or wire transfer should accompany the Purchase Order. All invoices not paid within terms will accrue late fees of 1.5% per month or portion thereof. It is expressly understood and agreed that all warranties do not become effective and are expressly contingent upon payment of all sums due and payable, including but not limited to, freight and handling charges, finance charges, attorneys fees, and late fees.

**3. Terms:** Payment terms and credit limit of approved credit customers will be determined by VLT based on business consideration, credit history, years in business, etc. VLT reserves the right to hold any orders if an account has open invoices that extend beyond payment terms or exceed approved credit limit. Standard terms are 50% Deposit and 50% prior to shipping. Custom orders always require a 50% deposit for release to production. No financing is available on a customer's first order.

**4. C.O.D. Orders:** All C.O.D. orders may be paid by company checks if approved by VLT. A \$15.00 C.O.D. fee will be added to the C.O.D. amount.

**5. International Orders:** All international orders must be pre-paid by wire transfer.

**6. Shipping:** Consult factory for current lead-time prior to order placement. All prices are Exworks Cedar Park, TX. Collect or pre-paid and additional methods of delivery and routing shall be at the seller's discretion. VLT reserves the right to add handling charges to any shipment. VLT does not permit "freight allowed" terms.

**7. Order Cancellation:** Cancelling of a Released Order will require a minimum \$100 cancellation fee. Furthermore, VLT reserves the right to charge a cancellation fee of up to 100% of the order total depending on the stage of Production, the level of customization of specified products, and several other factors to be taken into consideration at the time of cancellation.

**8. Returns:** See VLT "Limited Warranty" for return instructions on defective or unwanted products. Unwanted products that are both eligible for return and in original condition, must be returned within 30 days of invoice date and are subject to a 35% re-stocking fee. Custom-manufactured products, including but not limited to custom LED products and all fiber optic products, are NOT eligible for return and CANNOT be returned as "unwanted".

**9. Loss or Damage:** All products are tested, QC reviewed, and known to be in working order before leaving VLT. All title and risk of loss pass to buyer at seller's dock. Claims for lost or damaged products/shipments shall be made by the buyer with the transportation agent or shipping firm. Buyer must inspect equipment immediately upon receipt and report any damage to the appropriate party within 72 hours of receipt.

**10.** Prices are subject to change without notice.

**11.** All prices are stated in U.S. dollars.

**12.** VLT's Limited Warranty is contingent upon and does not become effective until orders are fully paid. The remedy under VLT's Limited Warranty is not available to clients and/or orders where there is an outstanding balance due and/or overdue invoice. VLT's Limited Warranty will be provided on request.

Customer Signature: \_\_\_\_\_



## Essential LEDs® 5 Year Limited Warranty

Visual Lighting Technologies (VLT) warrants its EssentialLEDs® Linear and EssentialLEDs® Light Panel products (not including damage to product incurred during shipment or transportation; see also VLT Terms and Conditions) as follows:

**LED Products:** VLT guarantees that all EssentialLEDs® products sold by VLT will be free from defects in material or workmanship for a period of five (5) years from the date of purchase subject to the Warranty Terms and Conditions detailed below.

**LED Drivers:** VLT guarantees that all LED driver products sold by VLT will be free from defects in material or workmanship for a period of five (5) years from the date of purchase subject to the Warranty Terms and Conditions detailed below.

**Warranty Terms:** VLT shall first attempt to repair any defective product and second replace it with the same model, or its equivalent model, at no charge, excluding any shipping charges. To obtain warranty service, or to send back unwanted product that is eligible for return:

- 1) A return authorization number (RMA#) must be obtained from VLT;
- 2) The product must be delivered or shipped prepaid to VLT; and
- 3) Proof of purchase - a bill of sale or invoice - indicating that the product is within the warranty period, must be sent to VLT to obtain warranty service. For unwanted product (in original condition and where allowable), return must be made within 30 days of invoice date.
- 4) VLT shall not be liable for any incidental, direct, or indirect costs incurred in the removal or reinstallation of any product returned for repair or replacement.

**Warranty Conditions:** This warranty will be void if the warranted items are:

- 1) Used, installed and/or maintained in such a manner that is not in accordance with VLT's specifications, recommendations, and/or procedures, including, but not limited to:
  - a) Mishandling, such as stretching, pulling, kinking, breaking, crimping, cutting or scratching of LED;
  - b) Any drilling of additional mounting holes or trimming of Light Panel pieces will nullify safety rating and void product warranty;
  - c) Failure to follow installation and maintenance manuals and/or instructions provided by the manufacturer;
  - d) Use with LED drivers other than those provided by VLT;
- 2) Modified or altered in any way by anyone other than VLT or VLT's authorized agents;
- 3) Not made available to VLT or its authorized agent for inspection, along with all installation, maintenance and other appropriate documents, when warranty claim is made.

This warranty does not include cosmetic damage, or damage to any part of the product resulting from acts of God, accident, shipping, misuse, abuse, improper storage or connection to an improper voltage supply.

VLT is not responsible for merchandise damaged in transit. Apparent or concealed damages that are incurred in transit should be reported immediately to the transportation carrier and an appropriate claim filed with the carrier.

Repaired or replaced products shall be subject to the terms of the original order Warranty (concurrent with the original Invoice date) and are inspected when packed for return shipment.

**Disclaimer of Other Warranties:** This Warranty (and any repair and replacement as provided herein) is the sole and exclusive remedy of any claims relating to items purchased through VLT; and no other warranties, express or implied, are given, including warranties of merchantability or fitness for any particular purpose. VLT shall not be liable for any incidental or consequential damages for breach of any express or implied warranty on this product. VLT will not be responsible for any representation, promise or expansion of this limited warranty by any dealer, sales or manufacturing representative or distributor of the products covered by this warranty. In the event that there is any statutory expansion of the provisions of the warranty expressed herein, the item will be deemed purchased on an as-is basis as to such expansion. Except as provided in this limited warranty all items are purchased in an as-is condition.

**Please contact VLT to verify that you qualify for warranty repair or replacement.**



**Visual Lighting Technologies**

1809 Hur Industrial Boulevard  
Cedar Park, TX 78613

Toll Free 877.VLT.1167

Phone 949.581.9398

Fax 737.205.5007

[info@vltcorp.com](mailto:info@vltcorp.com)

[www.vltcorp.com](http://www.vltcorp.com)

[www.essentialleds.com](http://www.essentialleds.com)

MADE IN USA 



Scan this special code using a QR reader on your smartphone to visit our website. Stay up to date on the latest VLT products and news!